

16

15

14

13

12

11

10

9

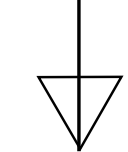

8

7

6

5

4

3

2

1

REVISION HISTORY			
REV	DESCRIPTION	DATE	APPROVED

L

L

K

K

J

J

I

I

H

H

G

G

F

F

E

E

D

D

C

C

B

B

A

A

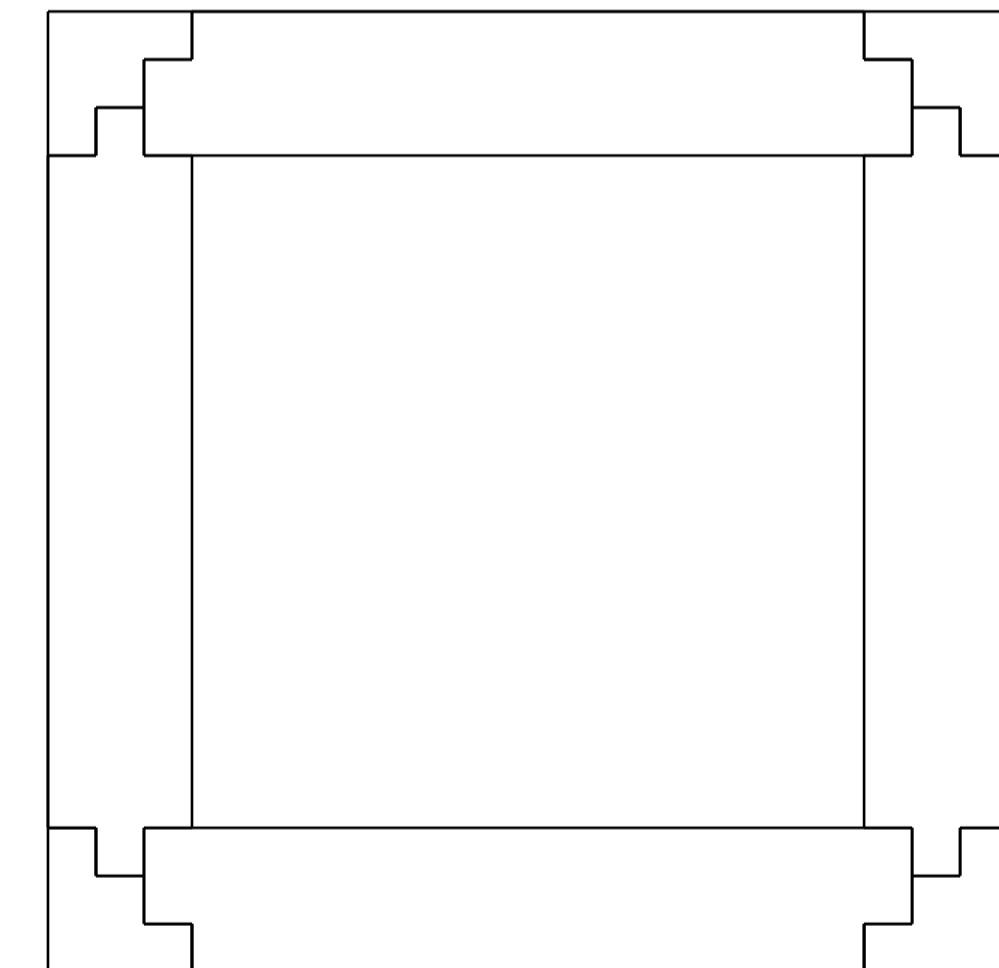
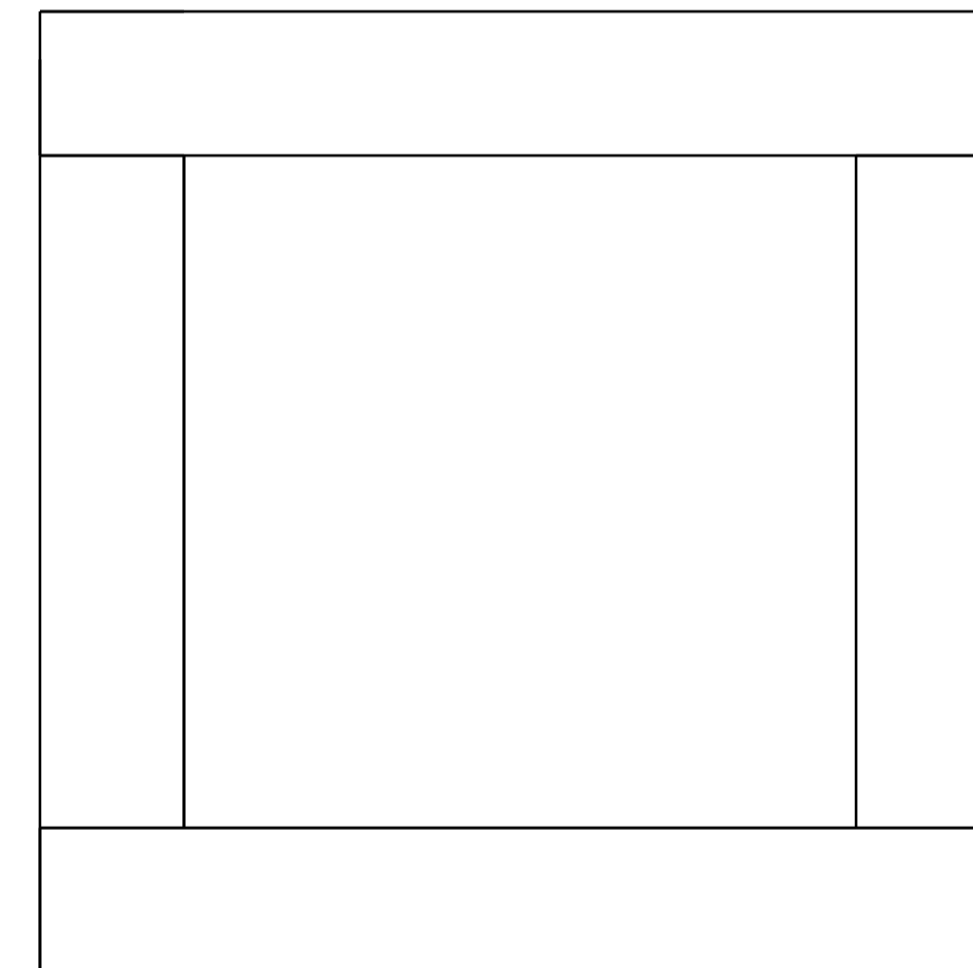
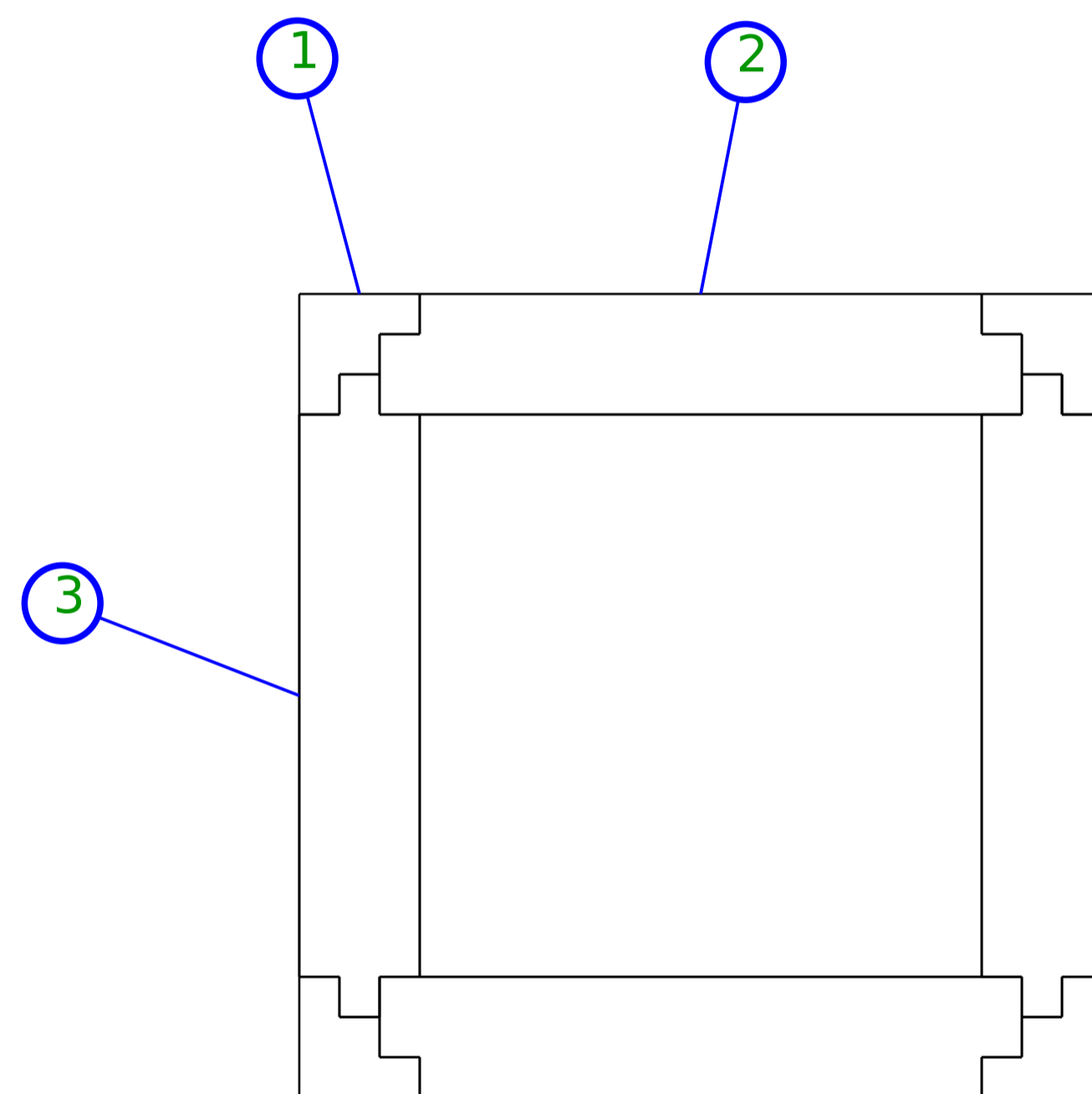
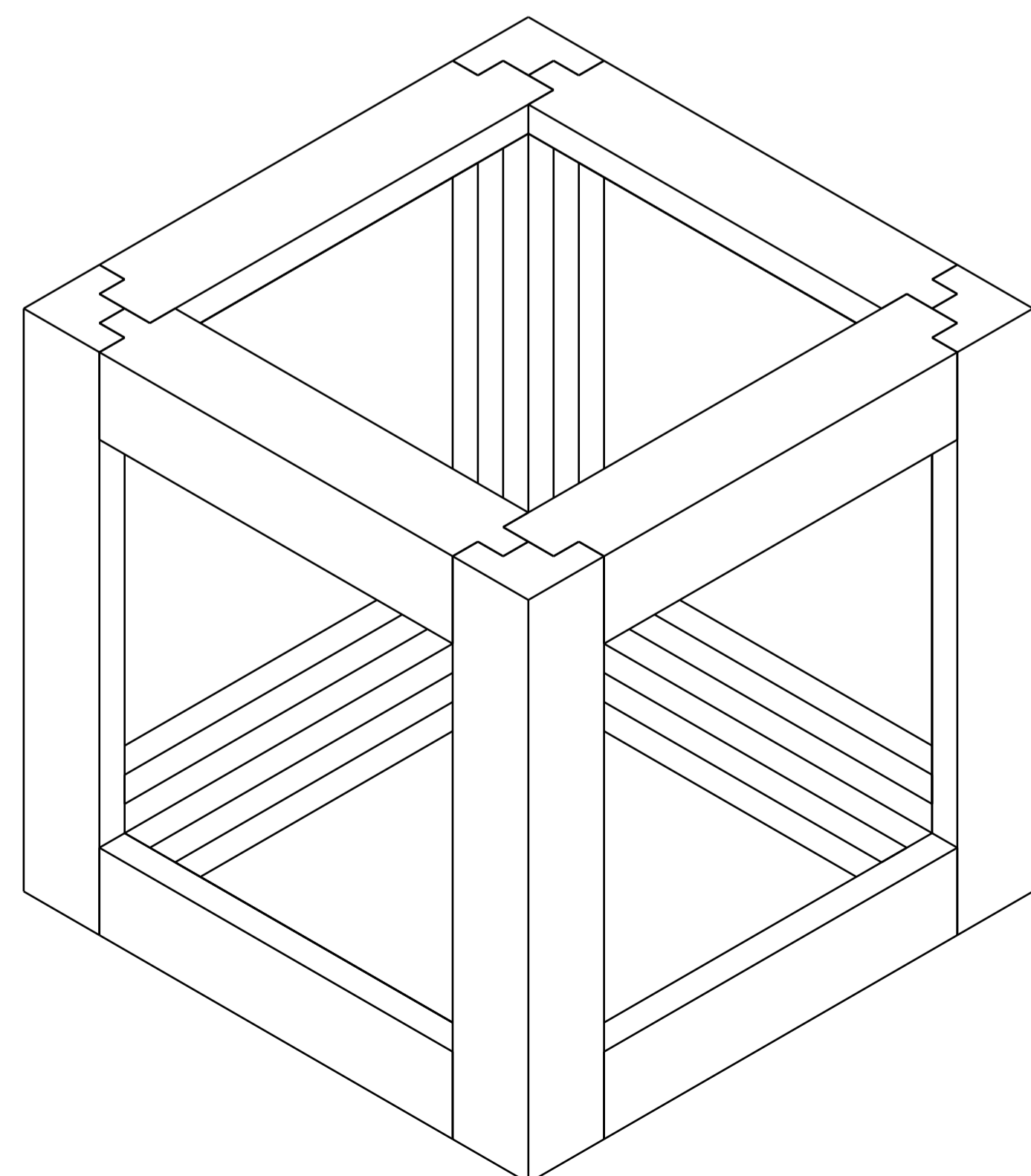

ITEM #	DESCRIPTION	QTY
3	FRAME_H2	4
2	FRAME_H1	4
1	FRAME_V	4

UNLESS OTHERWISE SPECIFIED
 DIM ARE IN INCHES (MM)
 TOL ON ANGLES ±1°
 ±.005 (±.1 MM)
 INTERPRET DIM AND TOL
 PER ASME Y14.5-2013

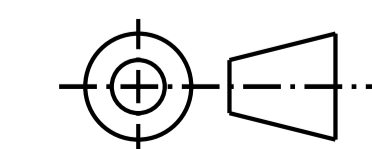

AUTHOR
N. CLAMPITT
 DATE
20170627

ChipsWoodShop.com

TITLE
CUBE FRAME

SIZE A1	DWG NO 000006	REV -
SCALE 1:1	WEIGHT N/A	SHEET 1 / 2

This work is licensed under the Creative Commons Attribution-NonCommercial-ShareAlike 2.5 Generic License. To view a copy of this license, visit <http://creativecommons.org/licenses/by-nc-sa/2.5/> or send a letter to Creative Commons, PO Box 1866, Mountain View, CA 94042, USA.

16

15

14

13

12

11

10

9



8

7

6

5

4

3

2

1

16

15

14

13

12

11

10

9



8

7

6

5

4

3

2

1

L

K

J

I

H

G

F

E

D

C

B

A

L

K

J

I

H

G

F

E

D

C

B

A

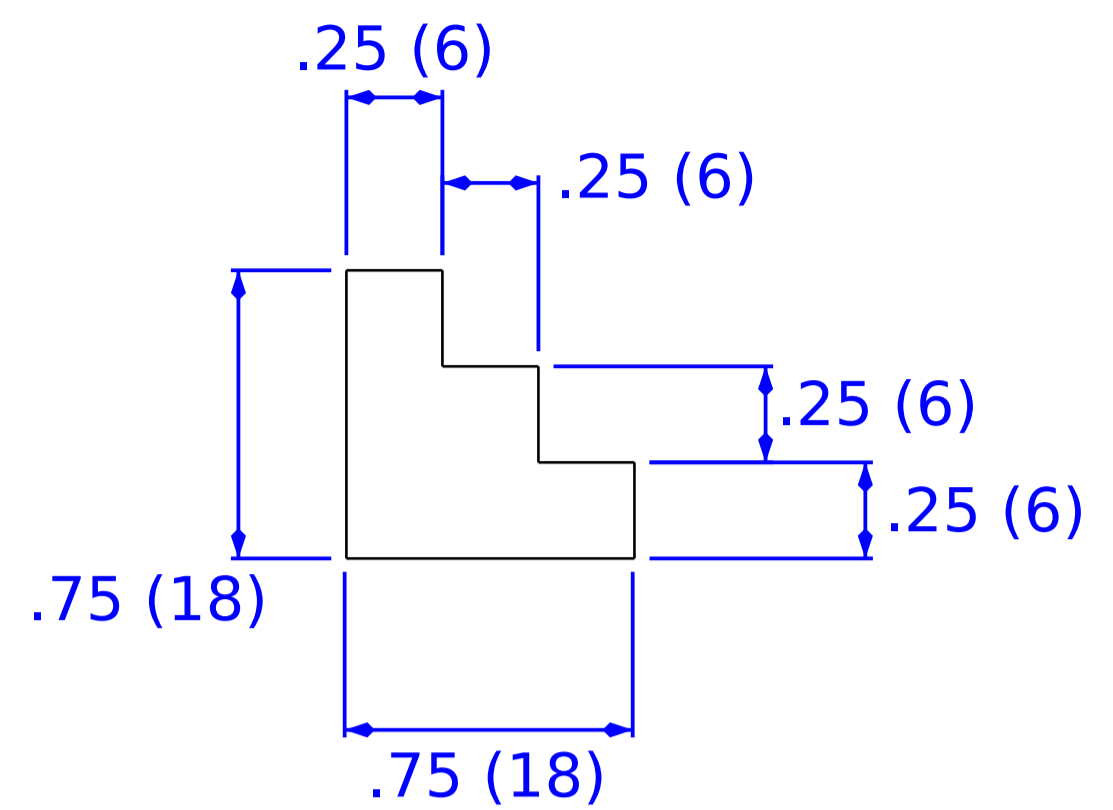

ITEM 1

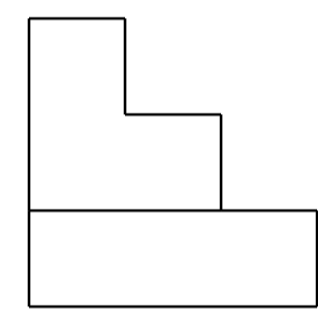
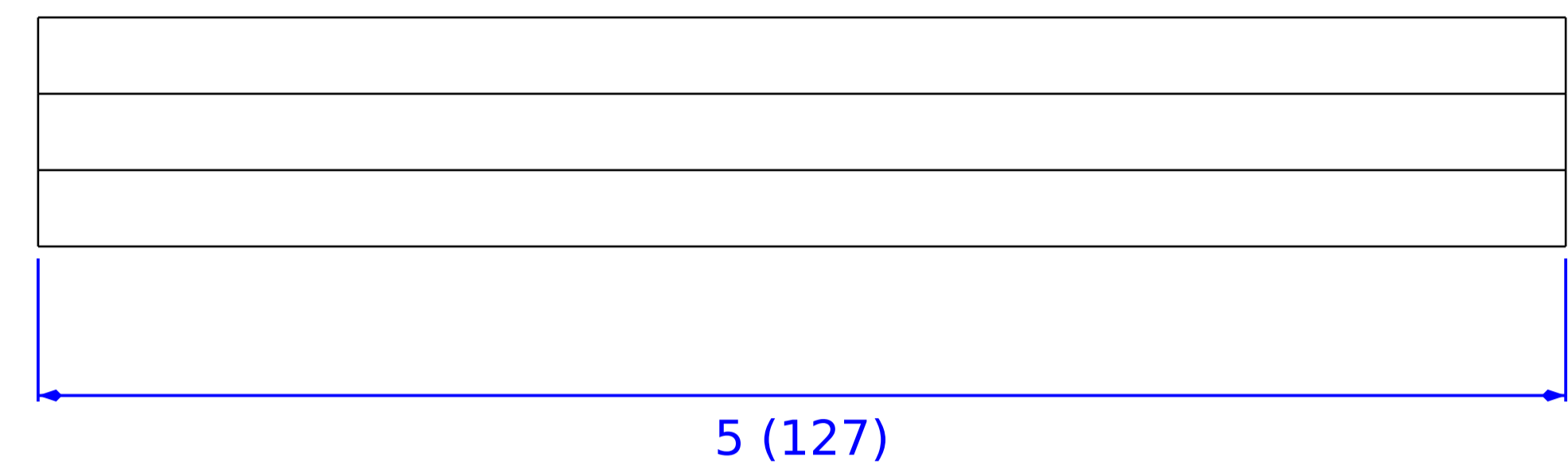

ITEM 2

SAME AS ITEM 1 EXCEPT AS SHOWN.

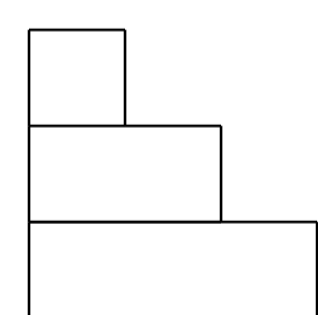
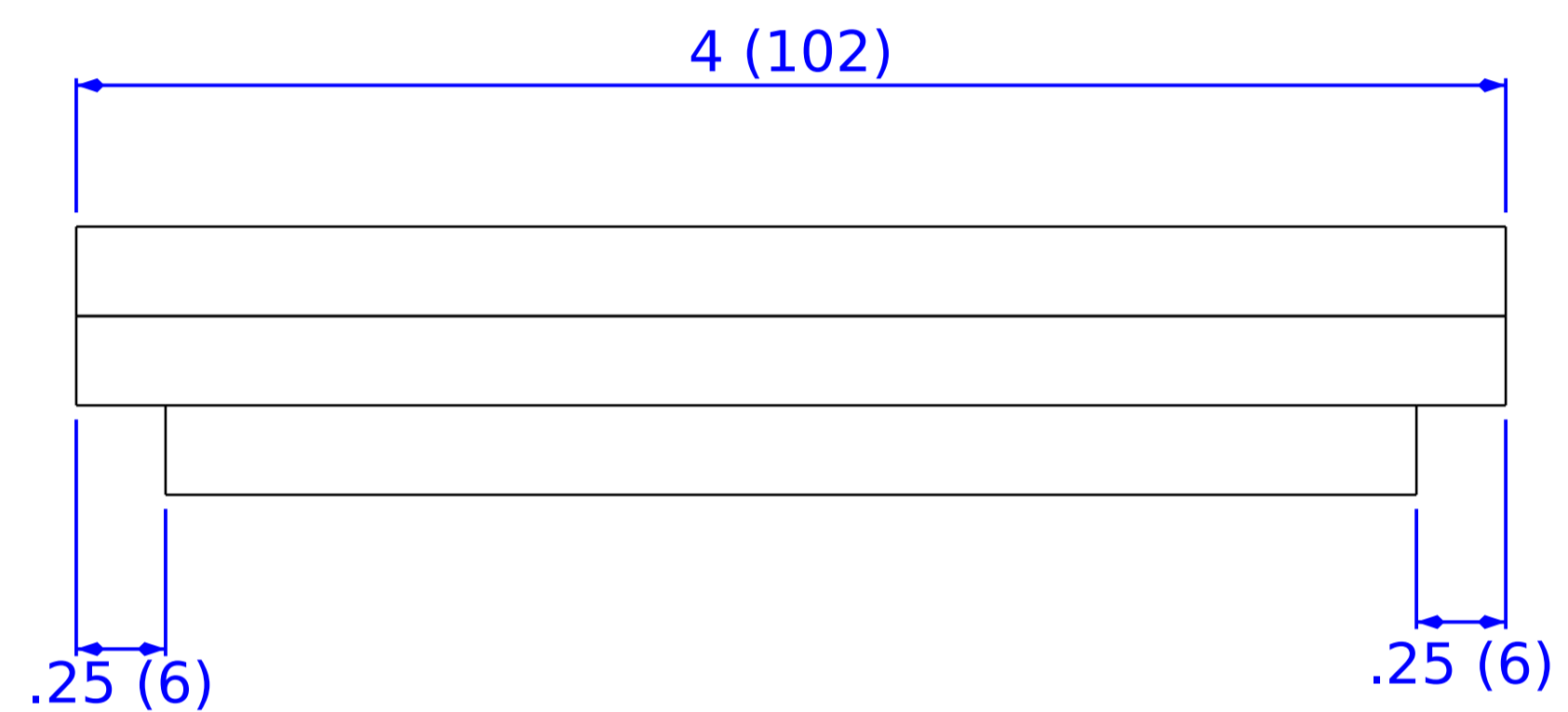

ITEM 3

SAME AS ITEM 2 EXCEPT AS SHOWN.

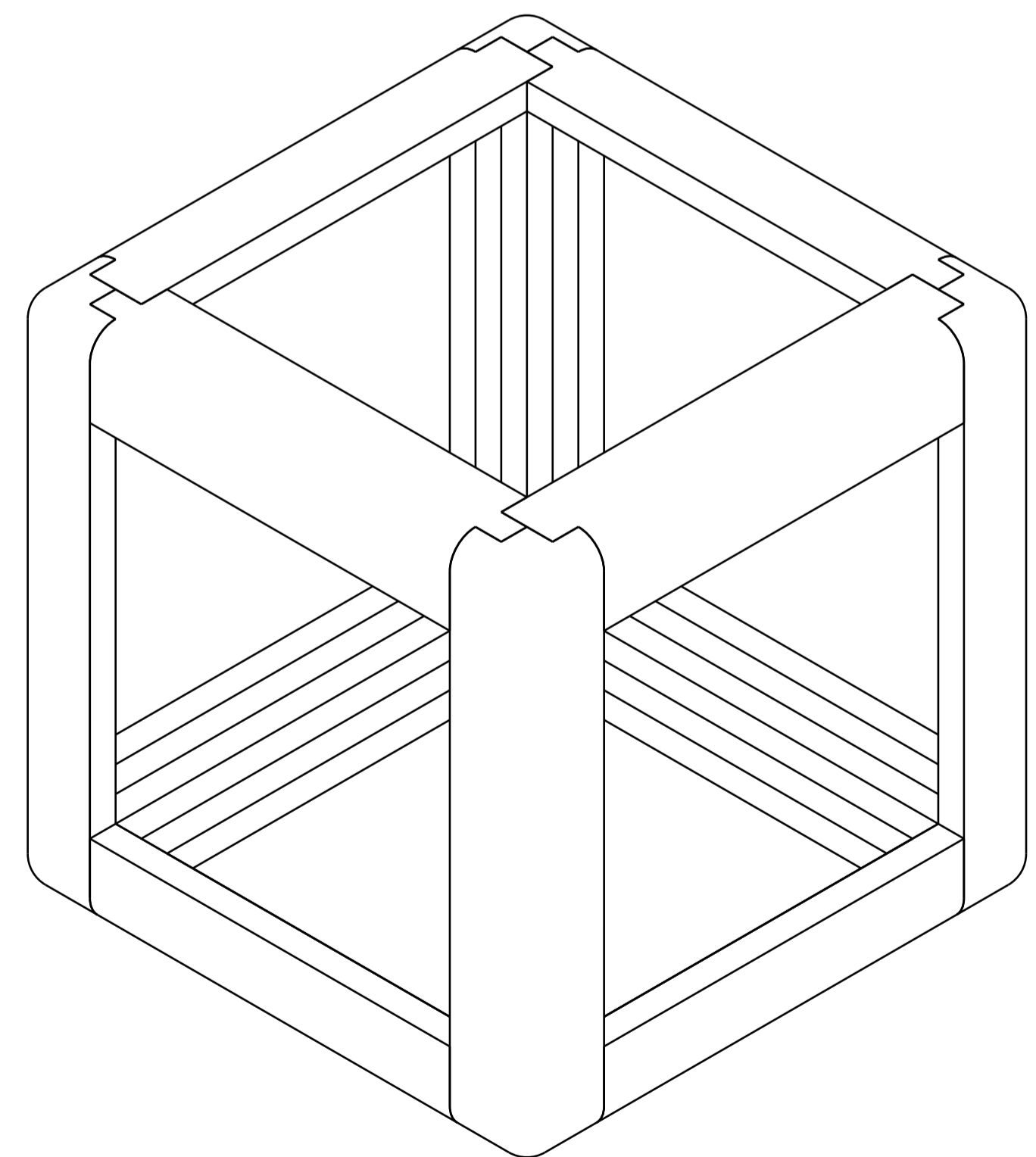
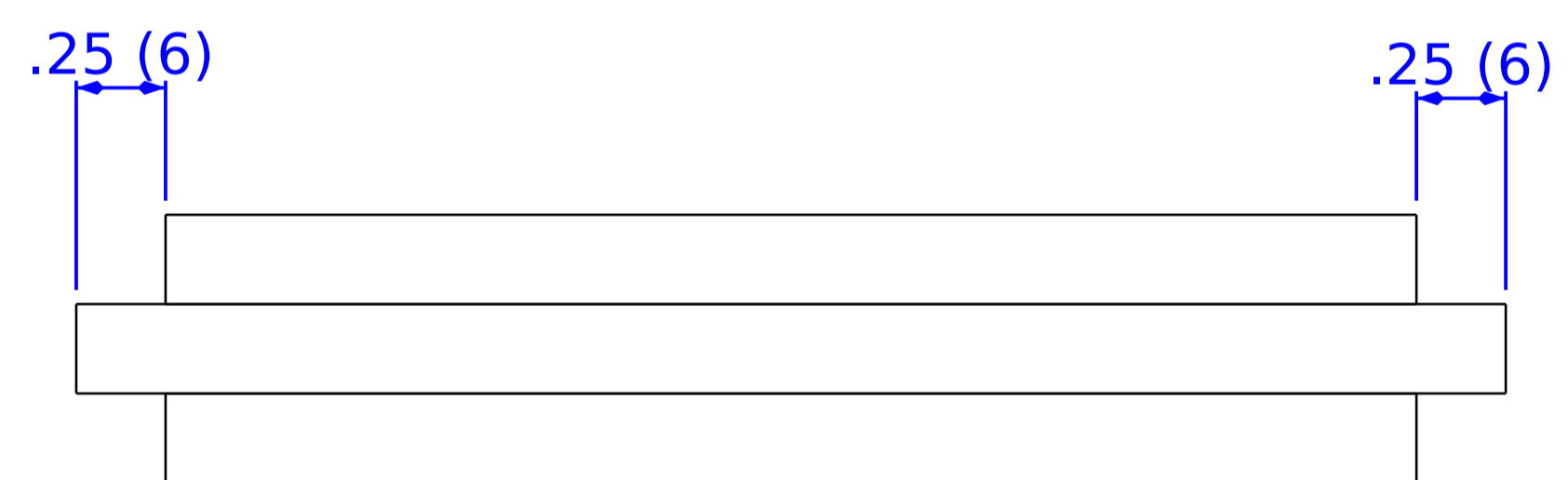

ASSEMBLY SHOWN WITH R.25 1/4 ROUND ALL AROUND.

This work is licensed under the Creative Commons Attribution-NonCommercial-ShareAlike 2.5 Generic License. To view a copy of this license, visit <http://creativecommons.org/licenses/by-nc-sa/2.5/> or send a letter to Creative Commons, PO Box 1866, Mountain View, CA 94042, USA.

SIZE A1	DWG NO 000006	REV -
SCALE N/A	SHEET 2 / 2	

16

15

14

13

12

11

10

9



8

7

6

5

4

3

2

1