

# Biosand Filter Construction Manual

---

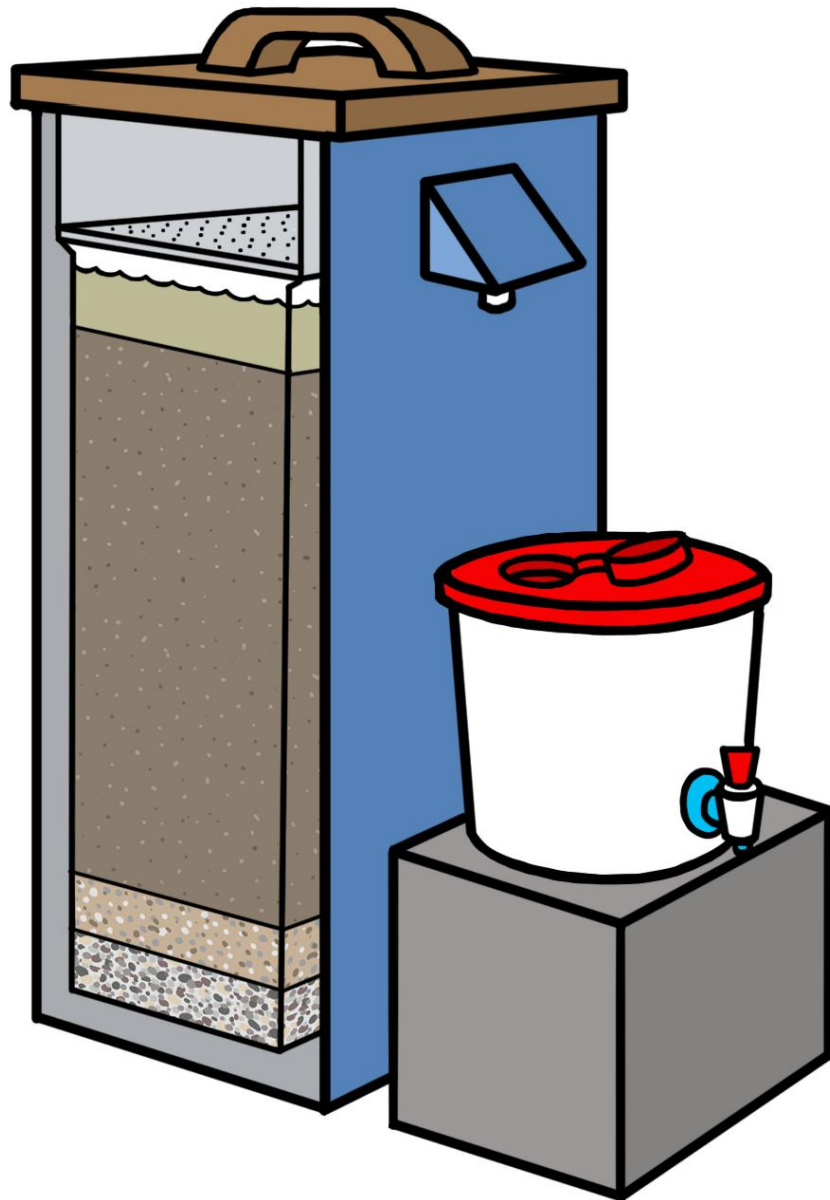





12, 2916 – 5<sup>th</sup> Avenue NE  
Calgary, Alberta, T2A 6K4, Canada  
Phone: + 1 (403) 243-3285, Fax: + 1 (403) 243-6199  
E-mail: [cawst@cawst.org](mailto:cawst@cawst.org), Website: [www.cawst.org](http://www.cawst.org)

CAWST, the Centre for Affordable Water and Sanitation Technology, is a nonprofit organization that provides training and consulting to organizations working directly with populations in developing countries who lack access to clean water and basic sanitation.

One of CAWST's core strategies is to make knowledge about water common knowledge. This is achieved, in part, by developing and freely distributing education materials with the intent of increasing the availability of information to those who need it most.

This document is open content and licensed under the Creative Commons Attribution Works 3.0 Unported License. To view a copy of this license, visit <http://creativecommons.org/licenses/by/3.0> or send a letter to Creative Commons, 171 Second Street, Suite 300, San Francisco, California 94105, USA.



You are free to:

- Share – to copy, distribute and transmit this document
- Remix – to adapt this document



Under the following conditions:

- Attribution. You must give credit to CAWST as the original source of the document. Please include our website: [www.cawst.org](http://www.cawst.org)

CAWST will produce updated versions of this document periodically. For this reason, we do not recommend hosting this document to download from your website.



### Stay up-to-date and get support:

- Latest updates to this document
- Other workshop & training related resources
- Support on using this document in your work

*CAWST provides mentorship and coaching on the use of its education and training resources.*

**[www.cawst.org](http://www.cawst.org)**

CAWST and its directors, employees, contractors, and volunteers do not assume any responsibility for and make no warranty with respect to the results that may be obtained from the use of the information provided.



## Table of Contents

---

|   | <b>Page</b> |
|---|-------------|
| Abbreviations .....   | iv          |
| Measurement Conversions .....                               | iv          |
| Glossary.....   | v           |
| Drawings of the Biosand Filter .....                        | viii        |
| <br>  |             |
| <b>PART 1: WHAT IS A BIOSAND FILTER? .....</b>              | <b>1</b>    |
| The Multi-Barrier Approach to Safe Drinking Water.....      | 2           |
| What is a Biosand Filter? .....                             | 4           |
| How Does a BSF Work? .....                                  | 4           |
| The Parts of a BSF .....                                    | 5           |
| What Does Each Part Do? .....                               | 6           |
| Version 10.0 Biosand Filter Specifications .....            | 8           |
| How Does the BSF Make Water Safe? .....                     | 9           |
| What Happens to the Pathogens and Dirt in the Filter?.....  | 9           |
| What Makes the BSF Special? The Biolayer!.....              | 10          |
| How the Biosand Filter Operates .....                       | 13          |
| What Kind of Water Can I Use? .....                         | 15          |
| The History of the Biosand Filter .....                     | 17          |
| How Well Does the Biosand Filter Work?.....                 | 17          |
| What Will Tell Me If a Filter is Working Well? .....        | 19          |
| Self-Review (Part 1).....                                   | 21          |
| <br>  |             |
| <b>PART 2: BIOSAND FILTER CONSTRUCTION MANUAL .....</b>     | <b>23</b>   |
| BSF Construction Process .....                              | 24          |
| Construction Safety.....                                    | 25          |
| Working with Cement .....                                   | 26          |
| Tools and Materials Required to Make and Install BSFs ..... | 27          |
| Technicians' Gear .....                                     | 27          |
| Tools and Equipment.....                                    | 27          |
| Consumable Items.....                                       | 29          |
| Stage A: Set Up a Production Site .....                     | 31          |
| You will need.....  | 32          |

|  |    |
|--|----|
| Stage B: Find Sand and Gravel.....                                       | 37 |
| 1. What kind of sand do I need? .....                                    | 38 |
| 2. Where can I find sand?.....   | 38 |
| 3. Dry the sand and gravel.....  | 42 |
| Stage C: Sieve the Sand and Gravel.....                                  | 43 |
| 1. Concrete sand and gravel (for making the container) .....             | 44 |
| 2. Filtration sand and gravel (for inside the filter) .....              | 46 |
| 3. Sieve options.....  | 48 |
| 4. Tips for sieving the sand and gravel .....                            | 49 |
| 5. Store the sieved sand and gravel .....                                | 51 |
| Stage D: Wash the Filtration Sand and Gravel .....                       | 53 |
| 1. Wash the separation and drainage gravel (for inside the filter) ..... | 54 |
| 2. Wash the filtration sand (for inside the filter) .....                | 55 |
| 3. Store the filtration sand and gravel .....                            | 58 |
| Stage E: Make the Concrete Container.....                                | 59 |
| 1. Prepare the mold.....   | 60 |
| 2. Pour the filter .....   | 62 |
| 3. Remove the filter from the mold.....                                  | 65 |
| 4. Finish the concrete container.....                                    | 68 |
| 5. Make the filter look nice .....                                       | 70 |
| Stage F: Make the Diffuser .....   | 71 |
| Stage G: Make the Lid .....  | 73 |
| Stage H: Install the Filter.....   | 75 |
| 1. Things to take with you for an installation .....                     | 77 |
| 2. Transport the filter and supplies for installation.....               | 78 |
| 3. Position .....  | 79 |
| 4. Put in the sand and gravel .....                                      | 79 |
| 5. Check the flow rate.....  | 83 |
| 6. Flush the filter.....   | 86 |
| Stage I: Educate the User .....  | 87 |
| 1. Educating the users.....  | 88 |
| 2. How to use the filter.....  | 88 |
| 3. How to clean the filter .....   | 91 |
| 4. Safe water storage .....  | 93 |
| 5. How to clean a safe storage container.....                            | 94 |

|   |     |
|---|-----|
| 6. Using your treated water.....                  | 95  |
| Stage F: Follow-Up With the User .....            | 97  |
| 1. Follow-up visits .....                         | 98  |
| 2. How to do a household visit.....               | 98  |
| 3. Things to check during a follow-up visit ..... | 99  |
| Self-Review (Part 2).....                         | 103 |
| <br>  |     |
| Additional Resources .....                        | 109 |
| References .....                                  | 110 |
| <br>  |     |
| Appendix 1: Monitoring Forms                      |     |
| Appendix 2: Troubleshooting Guide                 |     |
| Appendix 3: Diffuser and Lid Designs              |     |
| Appendix 4: The Cost of a Biosand Filter          |     |

## Abbreviations

|                 |                               |
|-----------------|-------------------------------|
| cm              | centimetre                    |
| ft              | foot                          |
| ft <sup>2</sup> | square feet                   |
| kg              | kilogram                      |
| L               | litre                         |
| m               | metre                         |
| m <sup>2</sup>  | square metres                 |
| min             | minute                        |
| mL              | millilitre                    |
| mm              | millimetre                    |
| NTU             | nephelometric turbidity units |
| oz              | ounce                         |
| '               | foot                          |
| "               | inch                          |
| <               | less than                     |
| >               | more than                     |
| /               | per                           |

## Measurement Conversions

### Flow Rate

0.4 L/min (litres per minute) = 400 mL/min (millilitres per minute)

0.4 L/min is the same as getting 1 litre of water in 2 ½ minutes (2 minutes and 30 seconds)

0.4 L/min is the same as 13.5 US-ounces per minute

1 litre in 2 minutes 30 seconds is the same as 33.8 US-ounces in 2 minutes 30 seconds

### Length or Distance

1 foot = 0.30 metres

1 metre = 3.28 feet

1 inch = 25.4 mm

1 inch = 2.54 cm

1 cm = 0.39 inches

1 mm = 0.1 cm

1 cm = 10 mm

### Volume

1 gallon = 3.78 litres

1 litre = 0.26 gallons

1 litre = 33.8 fluid oz (US)

400 mL = 13.5 fluid oz (US)

1 litre = 1000 millilitres

1 litre = 0.9 quarts (dry)

### Area

1 m<sup>2</sup> = 10.76 ft<sup>2</sup>

1 ft<sup>2</sup> = 0.09 m<sup>2</sup>



## Glossary

|                         |  |
|-------------------------|--|
| <b>Adsorption</b>       | When a contaminant attaches or sticks to the surface of a solid, such as a grain of sand.  |
| <b>Bacteria</b>         | Single-celled micro-organisms, typically a few micrometres in length. They can live in water, soil, in animals and on plants. Bacteria are usually too small to see with the human eye. Some, but not all bacteria can make you sick.  |
| <b>Biolayer</b>         | The biological layer formed in the top few centimeters of the sand in slow sand filters and biosand filters. The biolayer contains micro-organisms including bacteria, protozoa, algae, and diatoms. It is also called the schmutzdecke. The biolayer helps the filter treat water.          |
| <b>Boiling</b>          | Disinfection of water by heating it until it bubbles. To kill all the pathogens in the water, you must boil water at a full or “rolling” boil (lots of bubbles covering the whole surface of the water) for at least 1 full minute.  |
| <b>Cement</b>           | A powder made of limestone and clay. Cement powder is mixed with water, sand and gravel to make concrete.  |
| <b>Concrete</b>         | A strong construction material made of cement, sand and gravel.  |
| <b>Contamination</b>    | Pollution of water due to human or natural causes.   |
| <b>Disinfection</b>     | A process that removes, deactivates or kills pathogens in water. It is the last step of the household water treatment process, after sedimentation and filtration.   |
| <b>Filtration</b>       | The process of allowing water to flow through layers of a porous material such as sand, gravel or cloth. Filtration removes suspended solids and pathogens from the water. It is the second step of the household water treatment process, done after sedimentation and before disinfection. |
| <b>Flow rate</b>        | The speed at which water flows through the filter. The flow rate can be measured as the amount of time it takes to fill a container of water - often a 1 litre container. For the biosand filter, the flow rate should be measured when reservoir is completely full of water.               |
| <b>Galvanized steel</b> | Steel that is coated with zinc to prevent it from rusting. Galvanized steel in a thin sheet is called galvanized sheet metal.  |
| <b>Helminth</b>         | Worms. They can live in water, soil, in animals and on plants. Helminths can be very small (hard to see with the human eye), or large (up to meters in length!). They are parasites – they can live inside you and take nourishment (food) from you, making you sick.                        |

|                                      |   |
|--------------------------------------|---|
| <b>Hydraulic head</b>                | The driving force due to pressure and elevation difference that causes water to flow from one place to another. Head is usually expressed in units of height, such as centimetres or inches.  |
| <b>Hygiene</b>                       | Practices that help ensure cleanliness and good health, such as hand washing.   |
| <b>Implementation</b>                | The process of carrying out a plan. The implementation phase of a project happens after the project plan has been created.  |
| <b>Microbiological Contamination</b> | Harmful micro-organisms in water that can make you sick. Microbiological contamination can come from human excreta, garbage, animal excreta (manure), or from the soil, plants or environment.  |
| <b>Micro-organism</b>                | A tiny living thing, including protozoa, bacteria and viruses. Most are too small to see with the human eye. Micro-organisms, also called “microbes”, can live in water, soil, in animals or on plants. Not all micro-organisms will make you sick. |
| <b>Mold</b>                          | A form or empty container in a specific shape that is filled with concrete to make an object. The mold for making concrete biosand filters, described in this manual, is made from steel.   |
| <b>Nutrient</b>                      | Any substance used by micro-organisms to live and grow. The term is generally applied to nitrogen and phosphorus in contaminated water, but can be used to describe other chemicals.  |
| <b>Pathogen</b>                      | Any living organism that causes disease. Pathogens commonly found in water include bacteria, viruses, protozoa and helminths.   |
| <b>Pore</b>                          | The small spaces between the sand grains that allow water to flow through the sand.   |
| <b>Predation</b>                     | When a living thing (the predator) eats another living thing (the prey). In the biosand filter, micro-organisms in the biolayer eat other micro-organisms in the water.   |
| <b>Protozoa</b>                      | Multi-celled micro-organisms, often with a hard shell. They can live in water, soil, in animals and on plants. They are very small, but some protozoa can be seen with the human eye. Some, but not all protozoa can make you sick.                 |
| <b>Sanitation</b>                    | Maintaining clean, hygienic conditions that help prevent disease through services such as garbage collection, wastewater disposal, and using latrines.  |
| <b>Sedimentation</b>                 | The process of settling out suspended solids, dirt and sediment in water using gravity. It may involve adding chemicals or natural products to help the particles settle.   |

|                             |  |
|-----------------------------|--|
| <b>Siphon</b>               | A tube bent into a “U” shape, with one end put into a container or water or other liquid. Pressure and gravity force the water to flow up through the tube and out the open end. The water will stop flowing when the water level in the container is at the same level as the open end of the tube. The tube must be the correct diameter to be a siphon. The outlet tube in the biosand filter, described in this manual, is a siphon. |
| <b>SODIS</b>                | Solar disinfection of water by putting clear water in clear plastic bottles and leaving them in the sun. The UV rays from the sun kill the pathogens in the water.   |
| <b>Suspended solids</b>     | Small solid particles such as dirt which float in water and cause turbidity. They can be removed by sedimentation or filtration.   |
| <b>Treatment Efficiency</b> | How well the filter treats water. It is also called “removal efficiency”. It can be expressed as the percentage of specific contaminants that the filter removes from water, such as “98.5% of bacteria”. The treatment efficiency of the filter depends on the quality of construction, quality of filtration sand, source water quality, and user operation and maintenance.   |
| <b>Turbidity</b>            | The “cloudiness” or “dirtiness” of water. Turbidity is caused by suspended solids, such as sand, silt and clay, floating in water. Light reflects off these particles, which makes the water look cloudy or dirty. Turbidity is measured in nephelometric turbidity units (NTU).   |
| <b>Virus</b>                | Single-celled micro-organisms. They can live in water, soil, in animals and on plants. Viruses are too small to see with the human eye. Some, but not all viruses can make you sick.   |
| <b>Water quality</b>        | The chemical, physical, and microbiological characteristics of water. The quality of water required depends on what the water will be used for. Safe drinking water must be very high quality, with no harmful contaminants in it.   |

## Drawings of the Biosand Filter

The biosand filter is a large box. If it is sitting on the ground, it will come up to your waist, or higher. In this manual, the biosand filter is drawn in many ways. All of the drawings below show the biosand filter.

3-Dimensional – these drawings of the biosand filter show height, width and depth.

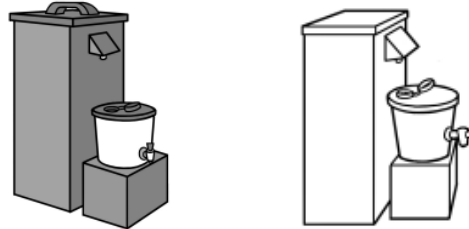

3-Dimensional Cut-Away – these drawings show the biosand filter with one wall removed so you can see the layers of sand and gravel. In real life, you cannot see inside the filter because the wall is there.

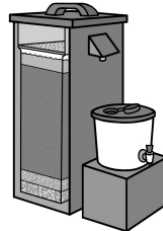

2-Dimensional – these drawings show the biosand filter as if you were looking at it from the side.

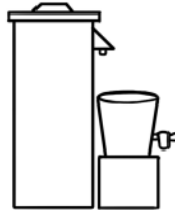

2-Dimensional Cut-Away – these drawings also show the filter from the side, but with a wall removed so you can see what is inside the filter. In real life, if you were looking at the filter from the side, you would not be able to see inside the filter.

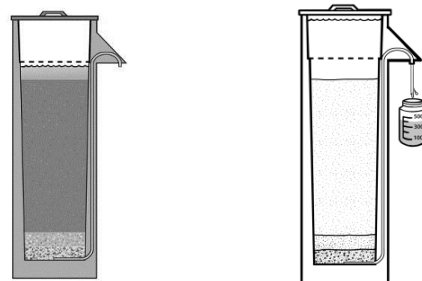

## **PART 1: WHAT IS A BIOSAND FILTER?**

## The Multi-Barrier Approach to Safe Drinking Water

---

The best way to reduce the risk of drinking unsafe water is to use the multi-barrier approach. The five steps of the multi-barrier approach to safe drinking water are:

1. Protect your source water
2. Sediment your water
3. Filter your water
4. Disinfect your water
5. Store your water safely

Each step in the process, from source protection to water treatment and safe storage, helps reduce health risks. The concept of the multi-barrier approach is also addressed as part of water safety plans, the principles of which can be applied at both community and household levels. The World Health Organization (WHO) provides additional information about water safety plans on their website.

**Household water treatment** is primarily focused on removing pathogens from drinking water – the biggest water quality issue around the world. There are some technologies that, while improving the microbiological quality, may also be able to remove certain chemicals such as arsenic and iron as a secondary benefit.

Both conventional and household systems follow the same basic water treatment process, which is the middle three steps of the multi-barrier approach: sedimentation, filtration and disinfection. The main difference between conventional (community) and household systems is the scale of the technologies used.

More often than not, people focus on a particular technology that is directed towards one step of the multi-barrier approach, rather than considering the whole water treatment process. While individual technologies can improve drinking water quality, the entire process is essential in providing the best water quality possible.

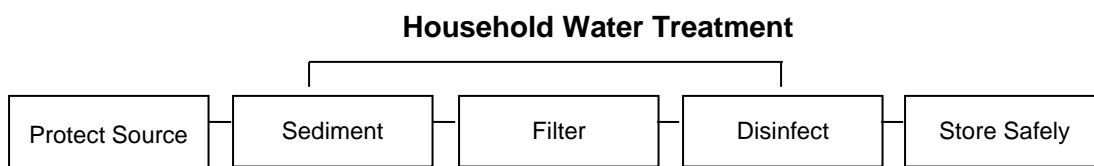

- Sedimenting water removes larger particles and often more than 50% of pathogens
- Filtering water removes smaller particles and often more than 90% of pathogens
- Disinfecting water removes, deactivates or kills any remaining pathogens

**The Multi-Barrier Approach to Safe Drinking Water**

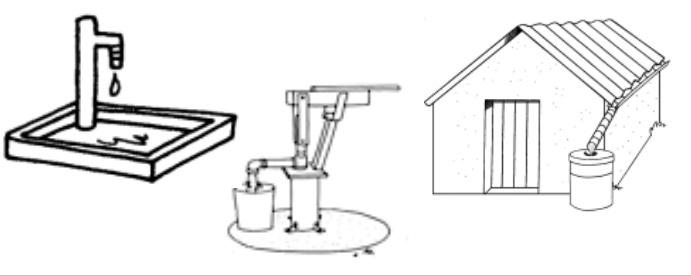
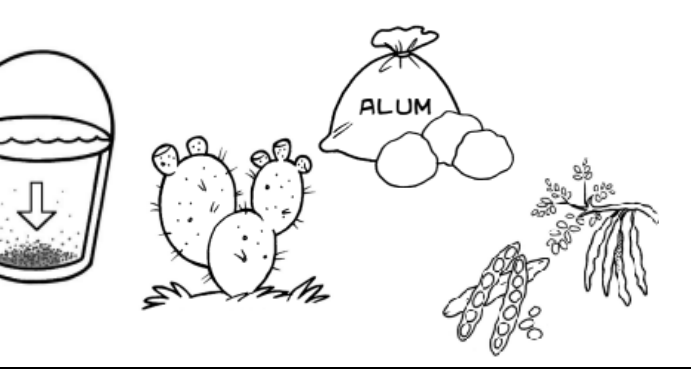
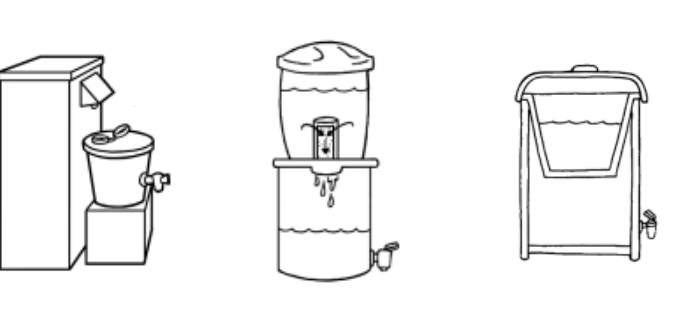
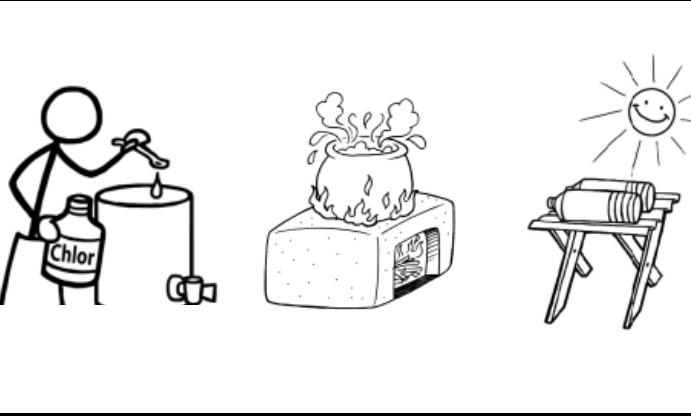
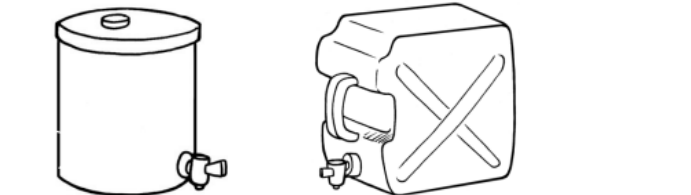
|  |  |
|--|--|
| <p><b>1</b></p> <p><b>Protect your source water</b></p> <p>Keep it clean. Keep human and animal waste out. Do not let any other water mix with the water—keep surface flow, runoff and wastewater out.</p>   |    |
| <p><b>2</b></p> <p><b>Sediment your water</b></p> <p>Let the dirt and large particles in the water fall to the bottom. You can either leave it to settle on its own or use alum, moringa seeds or prickly pear cactus to help the dirt settle.</p>   |    |
| <p><b>3</b></p> <p><b>Filter your water</b></p> <p>Filter out the rest of the dirt and larger pathogens that make you sick. You can use a filter like a biosand filter, a ceramic candle filter or a ceramic pot filter.</p>   |   |
| <p><b>4</b></p> <p><b>Disinfect your water</b></p> <p>After removing the dirt and large particles, disinfecting the water will get rid of any of the pathogens that are left—even the very small ones that were too small to be filtered out of the water. You can use chlorine, boiling, or solar disinfection (SODIS).</p> |  |
| <p><b>5</b></p> <p><b>Store your water safely</b></p> <p>Keep your treated water in a container that will keep it from getting dirty again.</p>  |  |

## What is a Biosand Filter?

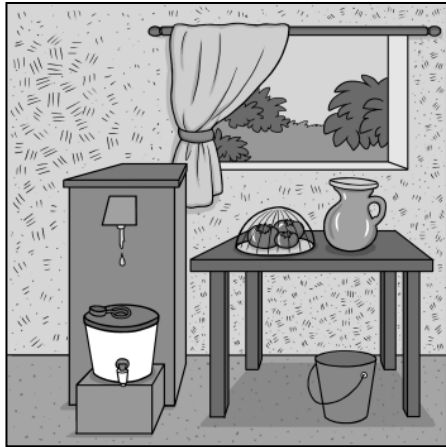

The biosand filter is also called a BSF. It is a water filter that makes dirty water safe to drink. It can be used in houses or buildings like schools. It can be made of concrete or plastic. It is filled with layers of sand and gravel that are carefully prepared to go inside the filter. The biosand filter falls under the “Filter Your Water” step of the multi-barrier approach to safe water.

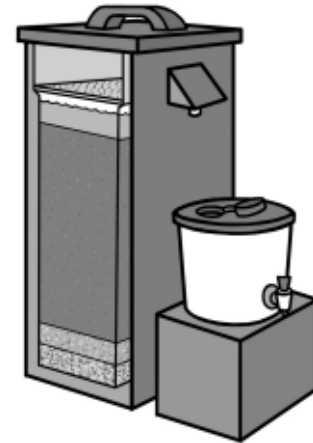

The BSF is an adaptation of the traditional slow sand filter, which has been used for community water treatment for almost 200 hundred years. The biosand filter is smaller and adapted for intermittent use, making it suitable for households.

## How Does a BSF Work?

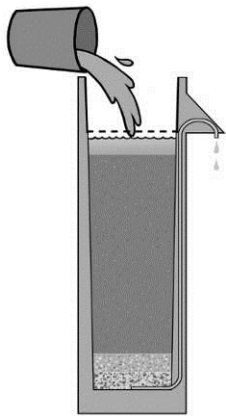

**1** Pour a bucket of dirty water in the top of the filter. Water will start to flow out of the tube. Put the lid back on the filter.

The filter should be filled between 1 and 4 times every day.

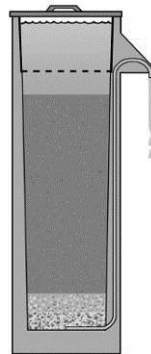

**2** The top of the filter is called the reservoir. It can hold 12 litres of water—about 1 bucket.

Water coming out will flow fastest when the reservoir is full.

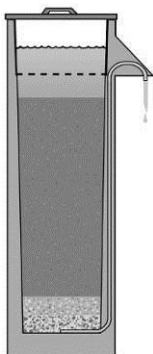

**3** It usually takes at least 1 hour for the water to stop flowing.

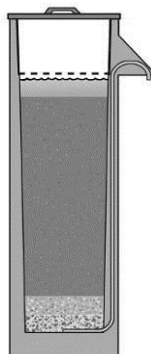

**4** After the water stops flowing, the filter must rest. The filter must rest for at least 1 hour before pouring more water in.

This is called the **Pause Period**.



## The Parts of a BSF

---

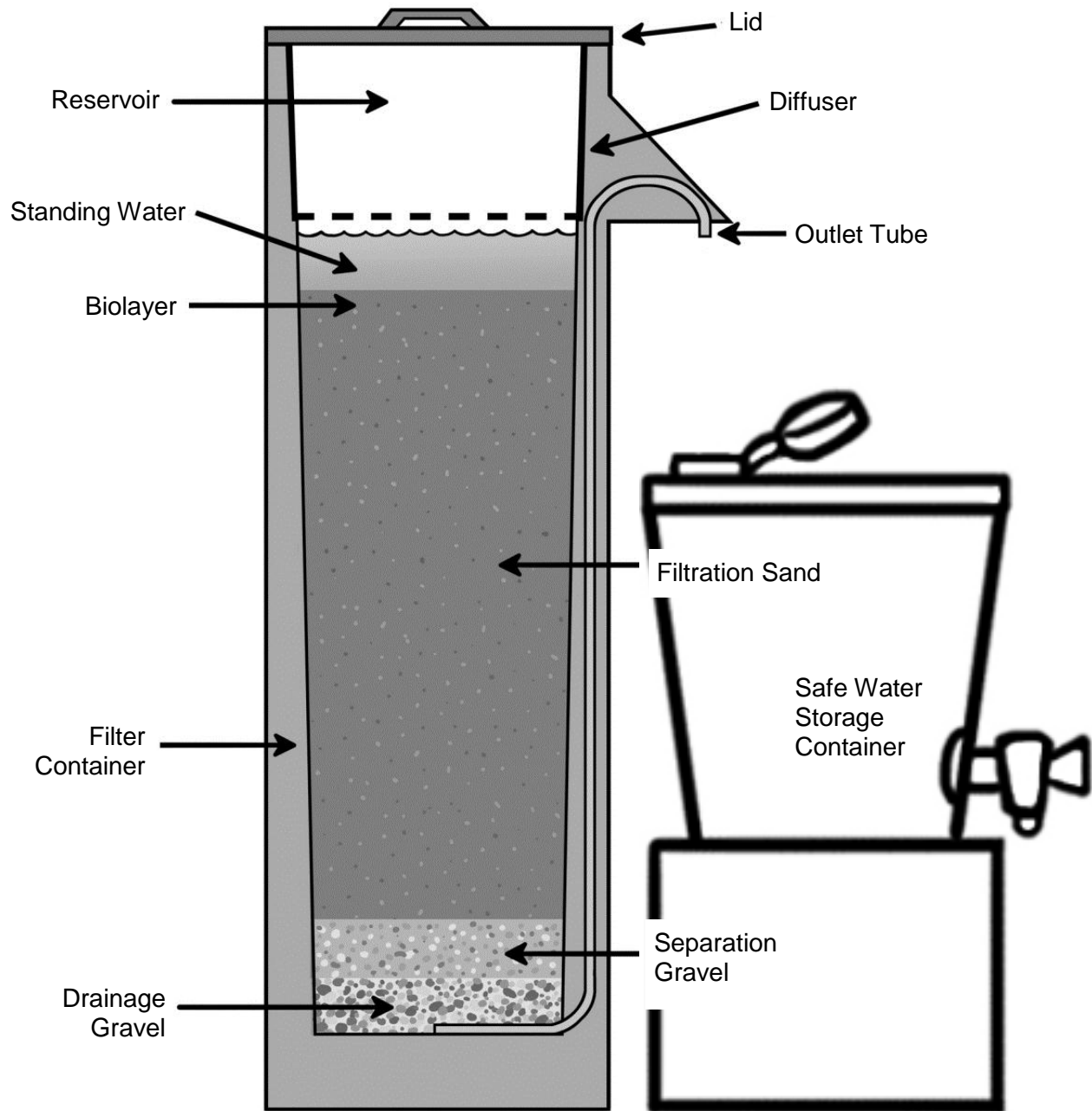

## What Does Each Part Do?

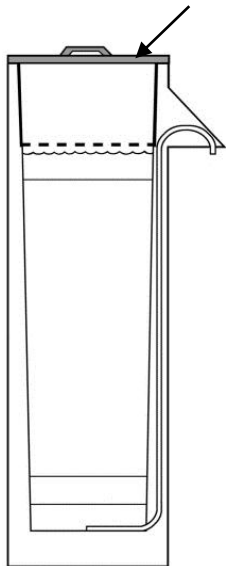

### Lid

The lid should be tight. It prevents contamination and keeps out unwanted pests.

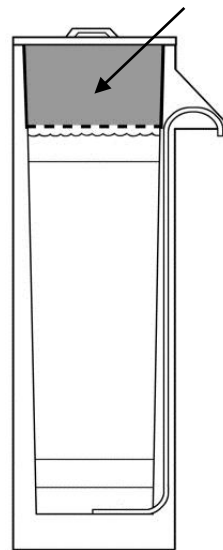

### Reservoir

The top of the filter where water is poured in is called the reservoir. The reservoir can hold about 12 litres, or 1 bucket of water.

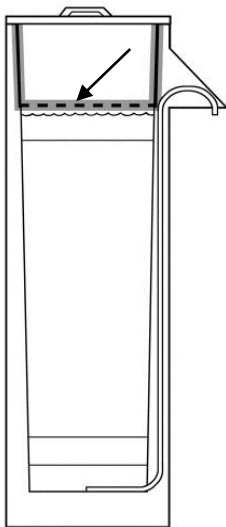

### Diffuser

The diffuser catches the water poured into the BSF. It can be a box or a plate. It has small holes in it, so the water slowly drips through to the sand.

The diffuser prevents disturbing the filtration sand and protects the biolayer from damage when the water is poured into the filter.

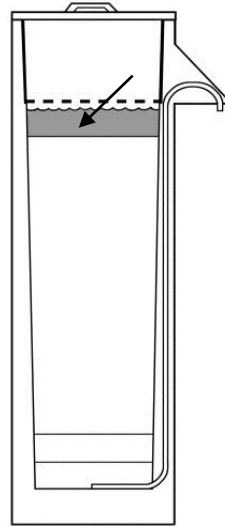

### Standing Water

When the water stops flowing, there should be 5 cm of water on top of the sand. This layer of water protects the top of the sand and the biolayer from the force of the dripping water.

The standing water also keeps the biolayer wet. The biolayer will die if it dries out.

The biolayer needs oxygen. Some oxygen can still get to the biolayer through 4 to 6 cm of water. But if there is more than 6 cm of water, the biolayer may die from lack of oxygen.

### What is the most important part?

The sand!

The sand removes pathogens from the water. The biolayer lives in the sand. If you do not get the right kind of sand, or do not prepare the sand properly, the biosand filter will not work well.

## What Does Each Part Do? –Continued

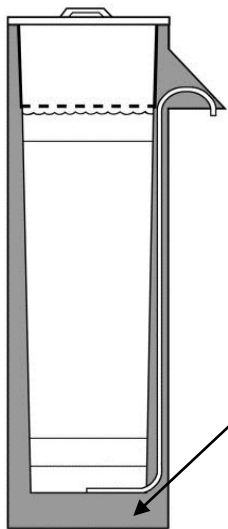

### Filter Container

The container can be made out of concrete or plastic. It can be square or round. It holds the sand, gravel and water. It can be painted on the outside to make it look nice.

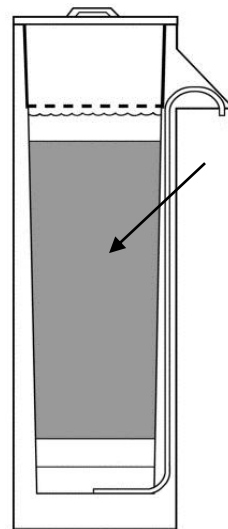

### Filtration Sand

The sand inside the filter is the most important part. The sand removes almost all the pathogens and dirt from the water. The sand must be prepared correctly for the filter to work.

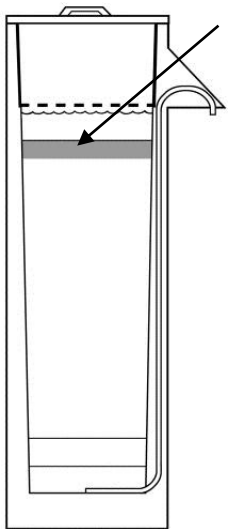

### Biolayer

The biolayer is the top layer of sand (1-2 cm or 0.8" deep), where very small microbes live. You cannot see them - they are too small. They eat the pathogens in the water that make you sick.

This layer also develops in conventional slow sand filters, where it is called the *schmutzdecke*.

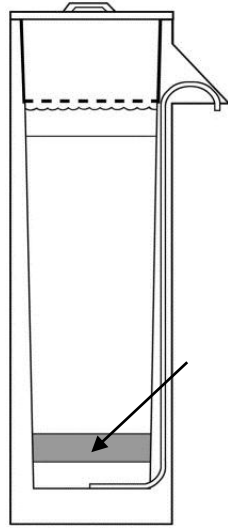

### Separation Gravel

The small gravel stops the sand from moving down and blocking the outlet tube.

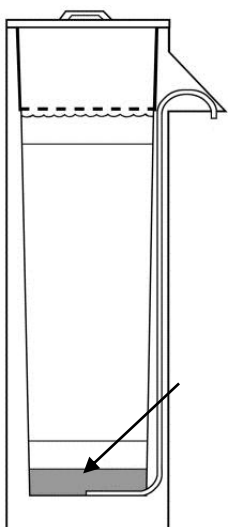

### Drainage Gravel

The large gravel stops the small gravel from moving and blocking the outlet tube. The large gravel is too big to get inside the outlet tube.

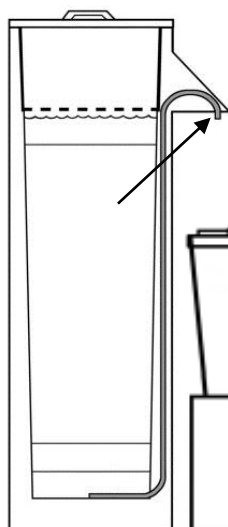

### Outlet tube

Water that comes out of the outlet tube is safe to drink. The tube can be made out of plastic or copper.

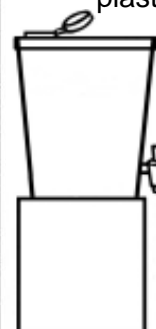

### Safe Storage

You must have a clean safe water storage container to collect the water as it flows out of the outlet tube.

## Version 10.0 Biosand Filter Specifications

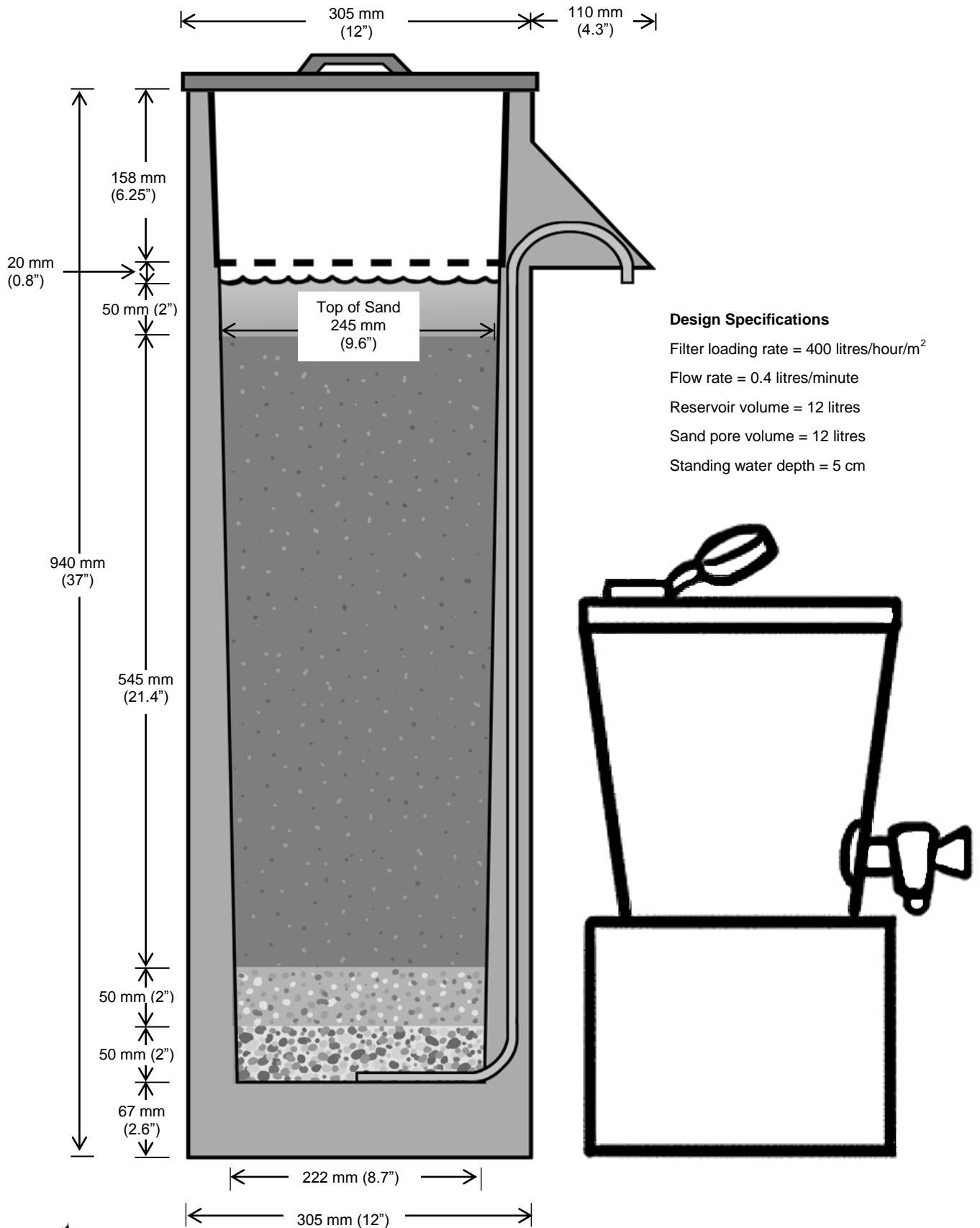

## How Does the BSF Make Water Safe?

There are very, very small living creatures called **microbes** in water. They are so small you can't see them with your eyes. Some of them make you sick when you drink them – these ones are called **pathogens**. The biosand filter removes almost all of the dirt and pathogens from water – up to 99%!

 For the safest drinking water, you should also disinfect the water after filtering it – for example by using chlorine, SODIS or boiling.

## What Happens to the Pathogens and Dirt in the Filter?

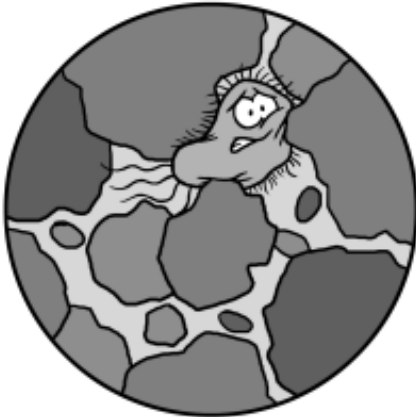

### Mechanical Trapping

**They get trapped in the sand.**

The water can flow through the sand, but some dirt and pathogens are too big to fit through.

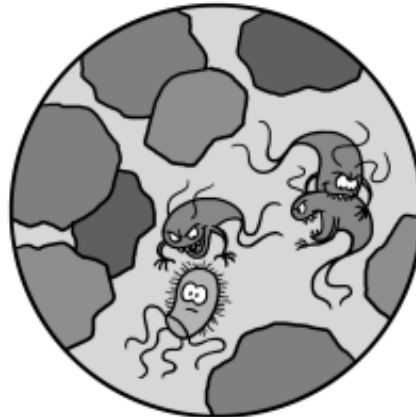

### Predation

**They get eaten.**

The microbes eat each other inside the filter, especially in the biolayer.



### Adsorption

**They get stuck to sand.**

Some pathogens stick to the sand and can't get away.

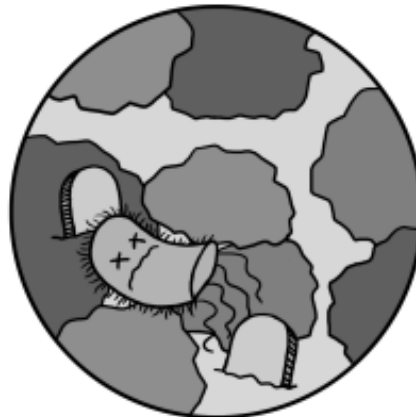

### Natural Death

**They die.**

Some pathogens die because there isn't enough food or air for them inside the BSF.

## What Makes the BSF Special? The Biolayer!

In a BSF, small microbes live in the top of the sand. This is called the **BIOLAYER**. The biolayer is very important for making the water safe to drink. The biolayer takes about 30 days to grow.

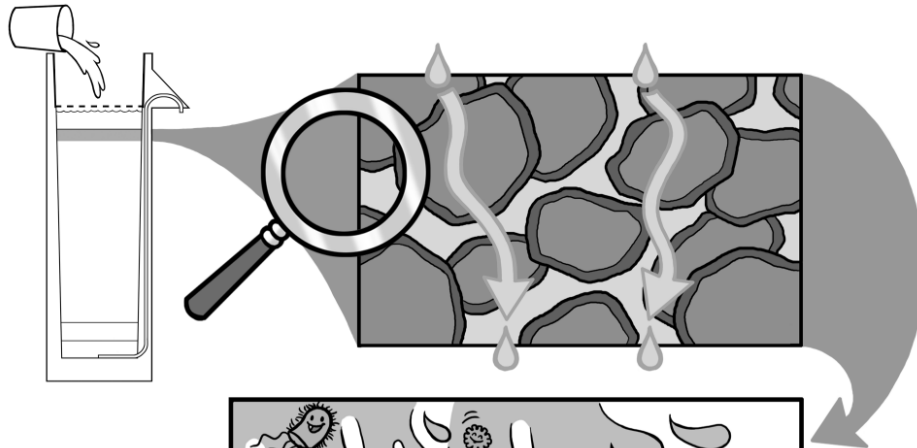

### Day 1

Many microbes live in water. They are too small to see, but they are there! When you pour water into the filter, the microbes start living in the top of the sand.

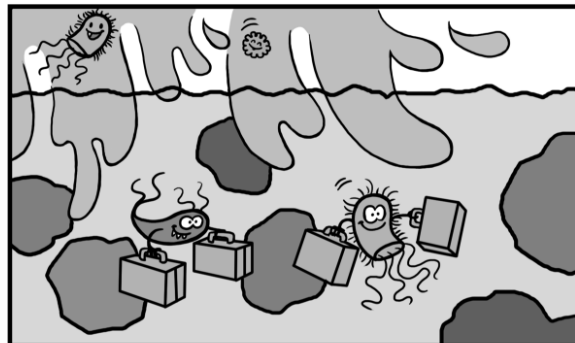

### Day 15

As you keep using the filter, more and more microbes start to live in the sand. The biolayer grows. The microbes get comfortable and start looking for food.

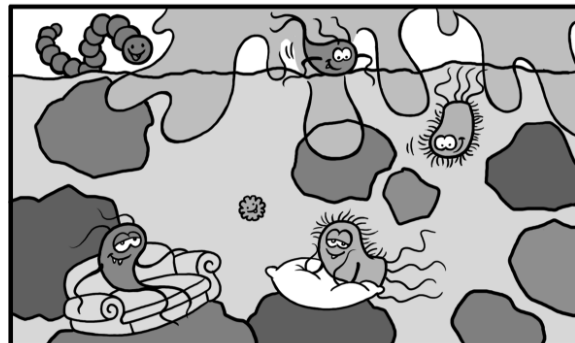

### Day 30

After a few weeks, the microbes start to eat each other. Now every time you pour water in, the microbes living in the sand will eat the new microbes in the water, including the pathogens.

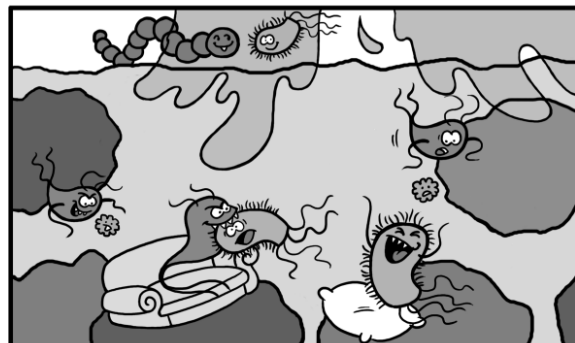

**The biolayer is the key component of the filter that removes pathogens.** Without it, the filter removes about 30-70% of the pathogens through mechanical trapping and adsorption. The ideal biolayer will remove up to 99% of pathogens.

It may take up to 30 days for the biolayer to fully form. During that time, the biolayer gets better at removing pathogens. The biolayer is NOT visible – it is NOT a green slimy coating on top of the sand. The filtration sand may turn a darker colour, but this is due to the suspended solids that have become trapped.

**The water from the filter can be used during the first few weeks while the biolayer is being established, but you still need to disinfect the water. .**

The following figure illustrates how the biolayer works. The process may vary as some filters require a shorter or longer period of time to establish the biolayer. The length of time it will take depends on the amount and source of water being used.

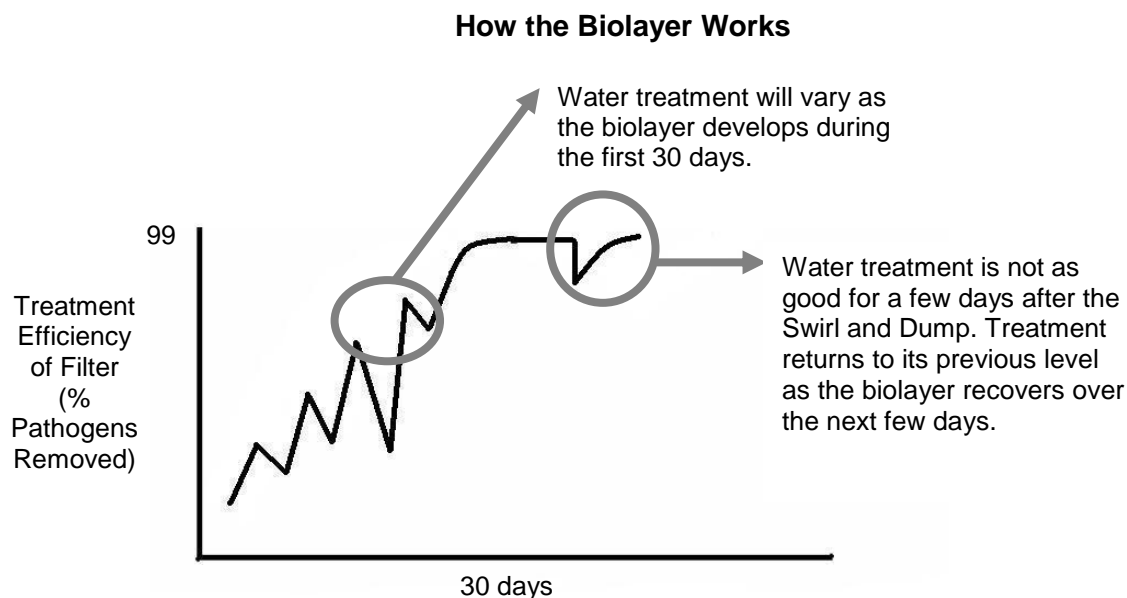

### The Biolayer and the Pause Period

The biosand filter is most effective and efficient when operated intermittently (not constantly flowing) and used consistently (every day). There must be a rest period or pause period between uses. **The pause period should be a minimum of 1 hour after the water has stopped flowing, up to a maximum of 48 hours.**

The pause period is important because it allows time for the micro-organisms in the biolayer to consume the pathogens in the water. This should be a minimum of 1 hour. If the pause period is extended for too long (over 48 hours), the micro-organisms will eventually eat all of the nutrients and pathogens in the water and then die from starvation. If the microbes in the biolayer die, the filter will not work as well or remove as many pathogens when it is used again. A long pause period may also cause the standing water in the filter to evaporate, causing the biolayer to dry out and die.

### The Biolayer and the Standing Water Level

**Correct installation and operation of the biosand filter requires a standing water depth of approximately 5 cm (2") above the sand during the pause period.** The standing water depth can be 4-6 cm (1.5-2.5"), but ideally it should be at 5 cm (2").

For filters with outlet tubes made of soft vinyl plastic with an inner diameter of 6 mm ( $\frac{1}{4}$ " ), there is a siphon effect in the tube. This means the water will stop flowing when the water surface inside the filter is at the same height as the *end of the outlet tube*. The filter should be installed so that the top of the sand is 4 to 6 cm (1.5-2.5") below the standing water level.

For older version filters with a larger diameter outlet tube (such as 12 mm ( $\frac{1}{2}$ " ) pvc pipe), there will be no siphon effect. The water will stop flowing when the water surface inside the filter is at the same height as the highest bend of the outlet pipe (within the nose). These filters must still be installed with enough sand so the standing water is 4 to 6 cm (1.5-2.5") deep.

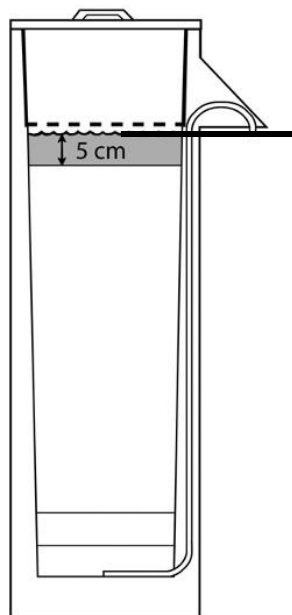

Water level in Version 9 or 10  
BSF with siphon effect

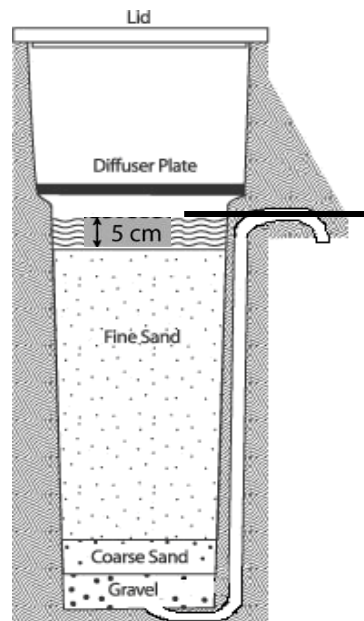

Water level in Version 8 BSF  
with no siphon effect

A standing water depth more than 6 cm (2.5") results in less oxygen moving through the water to the biolayer. Because the microbes in the biolayer need oxygen to survive, less oxygen means a thinner biolayer. A blocked outlet tube, an insufficient amount of sand installed in the filter or sand settling in the first few weeks of use can cause the standing water to be too deep.

A standing water depth less than 4 cm (1.5") may evaporate quickly in hot climates. This may cause the biolayer to dry out and die. Too much sand being put into the filter during installation, an outlet tube that is too long, or evaporation can cause the standing water to be too shallow.



## How the Biosand Filter Operates

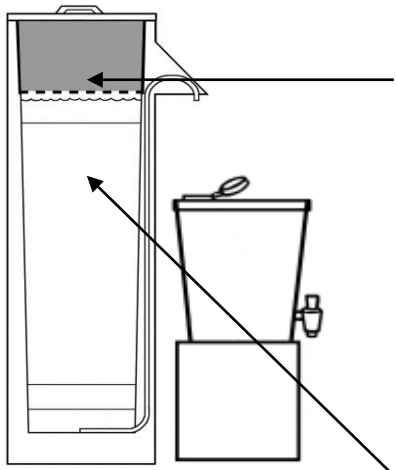

### During the Run (water is flowing)

When water is poured into the filter, the high water level (also called the hydraulic head) pushes the water through the diffuser and filter. The water level in the reservoir goes down as the water flows evenly down through the sand. When the reservoir is full, the flow rate should be 400 mL per minute. The flow rate will slow down as the reservoir empties because there is less pressure to force the water through the filter.

The inlet water contains dissolved oxygen, nutrients and contaminants. It provides some of the oxygen and nutrients required by the micro-organisms in the biolayer.

Larger suspended particles and pathogens are trapped in the top of the sand and they partially plug the pore spaces between the sand grains. This clogging causes the filter's flow rate to slow down over time. Users can periodically perform a Swirl and Dump maintenance procedure to restore the flow rate in the filter.

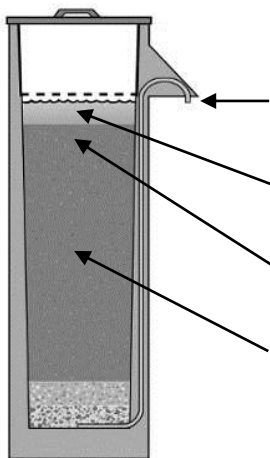

### Pause Period (no water is flowing)

The water will stop flowing when the standing water level is at the same height as the end of the outlet tube. (True for filters using outlet tube with an inner diameter of 6 mm (1/4"). See previous page.)

Some oxygen from the air diffuses through the standing water to the biolayer during the pause period.

The pause period allows time for micro-organisms in the biolayer to consume the pathogens and nutrients in the water.

Pathogens in the non-biological zone (below the biolayer) die off due to a lack of nutrients and oxygen during the pause period.

The pause period should be at least 1 hour.

### Filter Loading Rate and Flow Rate

There are several ways of talking about how fast water is flowing through the filter. The “*flow rate*” is what most people measure. The flow rate is how much water comes out of the outlet tube, usually in 1 minute or 1 hour. The target flow rate for a biosand filter depends on how big the filter is (surface area of sand). The flow rate is the most common way of talking about the flow because it is simple to measure: measure the volume of water coming out of the outlet tube in one minute.

The “*filter loading rate*” is a more accurate measure of how fast the water is moving through the sand. It does not depend on the surface area of sand. It can be described as the flow rate per square metre of sand surface area. There are well established target *filter loading rates* for sand filters. The biosand filter has been designed according to scientific processes so that its *filter loading rate* meets this target. For the concrete Version 10 biosand filter, the *filter loading rate* should be no more than 400 litres per hour per square metre (400 L/hr/m<sup>2</sup>) of sand surface area.

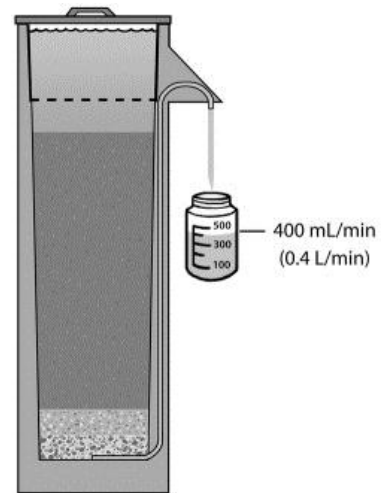

This *filter loading rate* is different than the *flow rate* because the surface area of the sand in the BSF is not one square metre. Because the dimensions are different for each version of the biosand filter, each version has a recommended flow rate. The recommended flow rate for the Version 10 biosand filter is 400 mL per minute. (Note: It is a coincidence of the design that both the *filter loading rate* and *flow rate* numbers are “400”!) The recommended flow rate for Version 8 and 9 biosand filters is 600 mL per minute.

Achieving the correct flow rate in biosand filters is very important for the proper functioning of the filter. The correct flow rate allows the filter to treat the water well. If the flow rate is too fast (more than 450 mL per minute), the pathogens may be forced through the filter too quickly and not as many pathogens will be removed from the water. The pathogen removal will not be as high in filters with higher flow rates. If the flow rate is too slow, the filter will treat the water well (possibly better!), but it may become inconvenient for the user. If the filter takes too long to produce treated water, people may not use the filter.

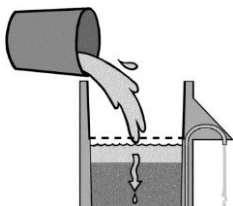

The “*Filter Loading Rate*” may also be called the “*Hydraulic Loading Rate*” or the “*Filtration Rate*”.

## What Kind of Water Can I Use?

You can use any kind of water in the BSF: water from the river, from a pond, from a well, or rainwater.

- **Use the best quality water you can in the filter.** The water should be the cleanest available since the filter is not able to remove 100% of the pathogens and turbidity (dirtiness or cloudiness). If the source water is very contaminated, the filtered water may still have some contaminants.
- **Use clear water.** The turbidity of the source water is also a key factor in the operation of the filter. Higher turbidity levels will plug the filtration sand layer more quickly. In this case, the user will need to do maintenance (a process called Swirl and Dump) more often to maintain a convenient flow rate. If the source water is over 50 NTU, it is recommended to use a sedimentation method before pouring the water into the filter. A simple test to measure the turbidity is to use a 2 litre clear, plastic bottle filled with the source water. Place this on top of a paper with large letters on it, such as the CAWST logo on this manual. If you can see the letters looking down through the top of the bottle, the water probably has a turbidity of less than 50 NTU.
- **Do not pour water that has been chlorinated into the filter.** The chlorine will kill the biolayer.

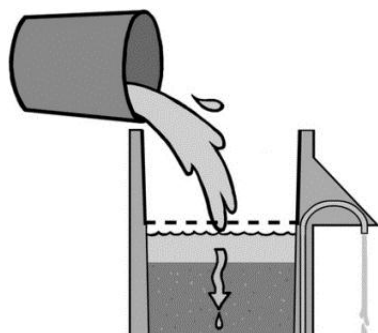

*Clear water*

The filter will work well. You will not have to clean the top of the sand very often.

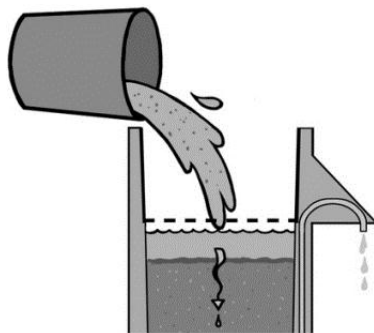

*Dirty water*

After a few weeks, the filter will start to flow slowly. You will have to clean the top of the sand sometimes to make it flow faster.

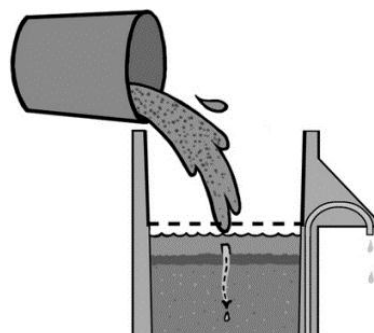

*Very dirty water*

The filter will quickly start to flow too slowly. You will have to clean the top of the sand often to make it flow faster.

If you have dirty water, settle the dirt out of the water by letting it sit in a bucket for a few hours before pouring it into the BSF.



**It is best to use water from the same source every time in the filter.**

- Over time, the biolayer becomes adapted to a certain amount and type of contamination from the source water.
- If you change the water source (for example, when the rainy season starts) it will have a different level and type of contamination.
- It may take the biolayer several days to adapt to the level of contamination and nutrients in the new source water. For a few days, the water coming out of the filter may not be as good quality as usual because the biolayer may not be able to consume all of the pathogens in the new water. You can drink this water, but it is a good idea to also disinfect the filtered water using chlorine, SODIS or by boiling the water.
- It is recommended to use the same source water all the time to get the cleanest, safest water.

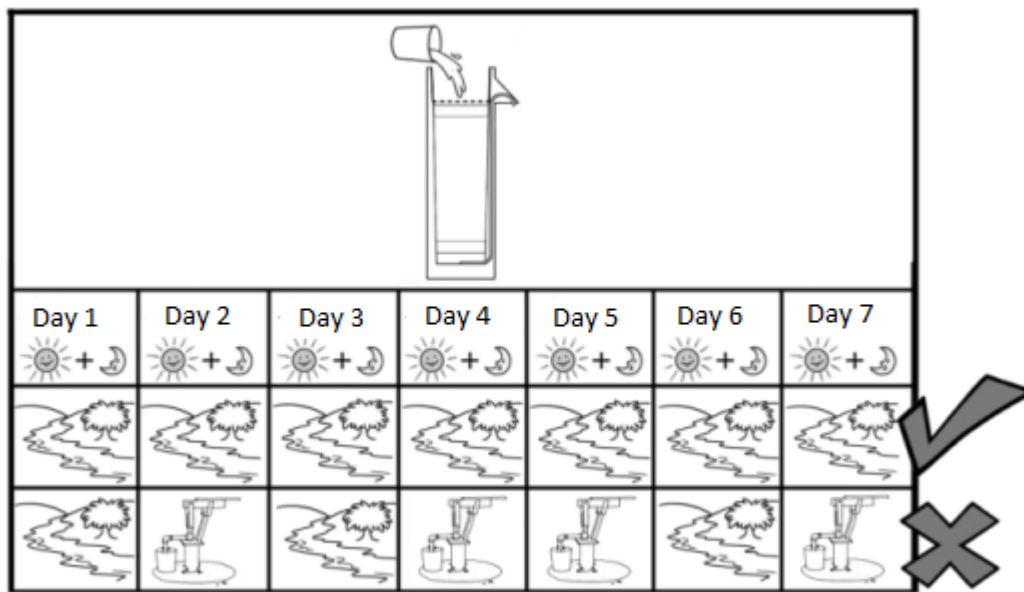

**Use the same source every day. You may change sources for the rainy or dry seasons.**

## The History of the Biosand Filter

---

Dr. David Manz developed the household biosand filter in the 1990s at the University of Calgary, Canada. Dr. Manz has trained many organizations on the design, construction, installation, operation and maintenance of the biosand filter. He also co-founded CAWST in 2001 to provide the professional services needed for the humanitarian distribution of the filter in developing countries. As of June 2011, CAWST estimates that over 300,000 biosand filters have been installed in more than 69 countries around the world.

## How Well Does the Biosand Filter Work?

---

Water naturally contains many living things. Some of these living things are harmless and others can make people sick. Living things that cause disease are also known as **pathogens**. They are sometimes called other names, such as micro-organisms, microbes or bugs, depending on the local language and country. There are four different categories of pathogens discussed in this manual: **bacteria, viruses, protozoa and helminths (worms)**. Contaminated water may contain hundreds or thousands of pathogens per litre.

The physical characteristics of drinking water are usually things that we can measure with our senses: turbidity, colour, taste, smell and temperature. **Turbid water looks cloudy, dirty or muddy**. Turbidity is caused by sand, silt and clay that are floating in the water. Drinking turbid water will not make people sick by itself. However, viruses, parasites and some bacteria often attach themselves to the suspended particles in water. **This means that turbid water usually has more pathogens. Drinking turbid water increases the chances of becoming sick.**

The biosand filter removes most of the turbidity as well as most of the pathogens from contaminated water. The biosand filter can remove almost all the protozoa and worms, 98% of bacteria, and more than 70% of the viruses. How many pathogens the biosand filter removes from the water depends on several factors, including how contaminated the water is before treatment. If there are a high number of bacteria in the water, even if the biosand filter removes 98% of them, there may still be some bacteria left in the filtered water.

How well the biosand filter treats water is also affected by how it is manufactured, installed and used. For example, the following factors can affect filter performance:

- Quality of the prepared filtration sand
- Quality of filter installation
- How frequently users pour water into the filter
- How frequently users clean the top of the sand (Swirl and Dump)
- Whether users always fill the filter with water from the same source

The following table shows the biosand filter performance based on results in published literature (studies and field trials). The table shows the percentage of pathogens and turbidity removed by the biosand filter.

### Biosand Filter Treatment Efficiency

|                   | Bacteria                             | Viruses                   | Protozoa            | Helminths               | Turbidity               | Iron                 |
|-------------------|--------------------------------------|---------------------------|---------------------|-------------------------|-------------------------|----------------------|
| <b>Laboratory</b> | Up to 98.5% <sup>1,2,3</sup>         | 70 to >99% <sup>3,4</sup> | >99.9% <sup>5</sup> | Up to 100% <sup>6</sup> | 95% <1 NTU <sup>1</sup> | Not available        |
| <b>Field</b>      | 87.9 to 98.5% <sup>7,8,9,10,11</sup> | Not available             | Not available       | Up to 100% <sup>6</sup> | 85% <sup>8</sup>        | 90-95% <sup>12</sup> |

1 Buzunis (1995)

2 Baumgartner (2006)

3 Jenkins et al. (2011)

4 Elliott et al. (2008)

5 Palmateer et al. (1997)

6 Not researched. However, helminths are too large to pass between the sand, up to 100% removal efficiency is assumed

7 Earwaker (2006)

8 Duke & Baker (2005)

9 Aiken et al. (2011)

10 Stauber et al. (2011); study of plastic BSFs

11 Murphy et al (2010)

12 Ngai et al. (2004)

Several studies have been done to estimate the health impact of using biosand filters. Overall, these studies estimate a 30-61% reduction in diarrhea among all age groups, including children under the age of five (an especially vulnerable population), from using a biosand filter (Sobsey, 2007; Stauber, 2007; Aiken et al., 2011; Stauber et al., 2011).

The World Health Organization guideline for safe drinking water is zero fecal bacteria (WHO, 2011). Because the biosand filter does not remove all pathogens, CAWST recommends users disinfect their filtered water.

In addition to removing microbiological contaminants and turbidity, the biosand filter can also remove iron from water. In areas where iron in the water is a problem (it can turn laundry and food red), this can help gain people's acceptance of the filter. The filter can also remove some heavy metals, although the long-term removal ability of the filter for metals has not been well studied.

Like all filters, the biosand filter cannot remove dissolved organic or synthetic chemicals (such as pesticides), hormones, or other dissolved substances. It will also not usually remove fluoride from water. Whether the filter will remove some metals and chemicals depends on the general chemistry of the water being poured into the filter. The amount of certain chemicals (or metals) in the water may either increase or decrease the filter's removal of other chemicals or metals from the water.

## What Will Tell Me If a Filter is Working Well?

There are 8 points that can tell you if a filter is treating water well. They are called the **8 Key Filter Performance Points**. If these 8 points are met, you can be confident that the filter is removing most microbiological contaminants.

**1 The filter was installed more than 30 days ago.** It takes 30 days for the biolayer to grow and be working well.

|      |      |      |      |      |      |      |
|------|------|------|------|------|------|------|
|      |      |      |      |      |      |      |
|      |      |      |      |      |      |      |
| ✓ 1  | ✓ 2  | ✓ 3  | ✓ 4  | ✓ 5  | ✓ 6  | ✓ 7  |
| ✓ 8  | ✓ 9  | ✓ 10 | ✓ 11 | ✓ 12 | ✓ 13 | ✓ 14 |
| ✓ 15 | ✓ 16 | ✓ 17 | ✓ 18 | ✓ 19 | ✓ 20 | ✓ 21 |
| ✓ 22 | ✓ 23 | ✓ 24 | ✓ 25 | ✓ 26 | ✓ 27 | ✓ 28 |
| ✓ 29 | ✓ 30 |      |      |      |      |      |

|  |  |  |  |  |  |  |
|--|--|--|--|--|--|--|
|  |  |  |  |  |  |  |
|  |  |  |  |  |  |  |
|  |  |  |  |  |  |  |
|  |  |  |  |  |  |  |

**2 The filter is used at least once every day, with water from the same source every time.** Don't forget the Pause Period: after the water stops running, you must wait at least 1 hour before filling it again.

**3 The water poured into the BSF is clear.** The source water should be less than 50 NTU. If you only have dirty or cloudy water, leave it in a bucket until the sediment has settled to the bottom. Then pour the clear water in the bucket into the BSF. Do not pour the sediment in.

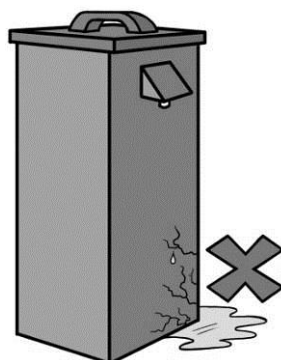
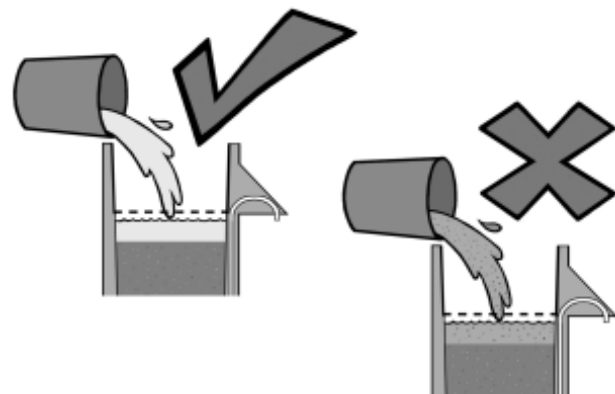

**4 The filter container does not have cracks and is not leaking.** Users may not use filters that don't look nice or that make a mess. Also, a leak may cause the standing water level to be too shallow, and the biolayer may be damaged.

**5 There is a diffuser.** It should be in good condition, so the biolayer is protected when you pour the water in. There should be no cracks or large holes in the diffuser.

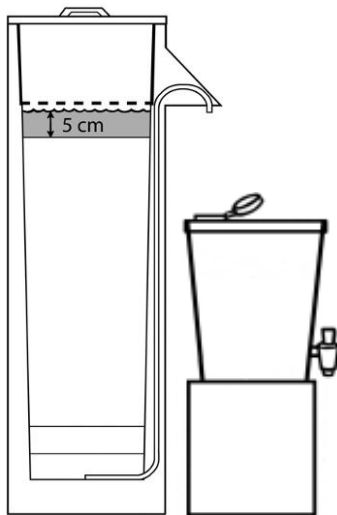
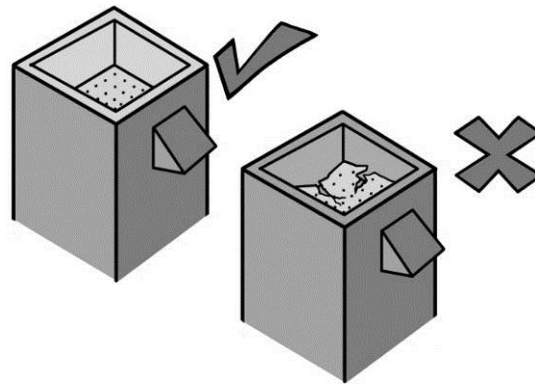

**6 When the water stops running, the water surface is 5cm (2") above the top of the sand.** If you don't have a ruler with you, 5 cm is about the length of your middle finger from the tip to the second knuckle. It is ok if the water depth is between 4 to 6 cm (1.5-2.5").

**7 The top of the sand is flat and level.** If there are dents, holes or "valleys" in the sand, the biolayer may be damaged.

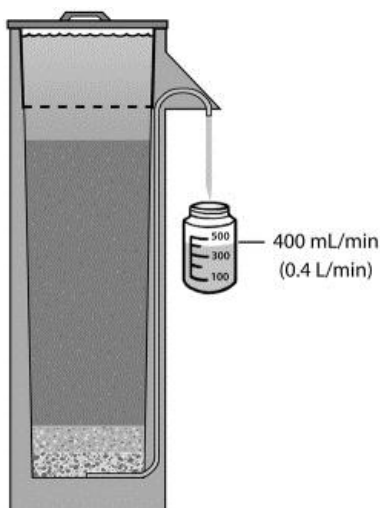
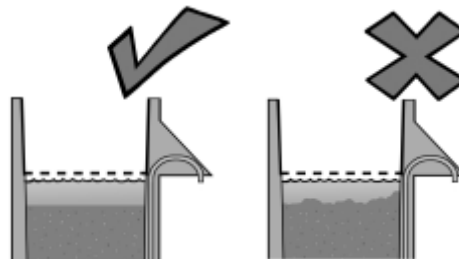

**8 When the filter is full, the flow rate is 400 mL or less per minute.** If you get more than 400 mL in 1 minute, the filter may not be operating at its highest possible treatment efficiency.

*\*Note: The flow rate should be 400 mL or less per minute for the newest filter design (Version 10). For previous versions of the filter (Version 8 or 9), the flow rate should be 600 mL or less per minute.*

For additional points to check when visiting filter users, see Part 2 of this manual, Stage J: Follow Up with the User



## **Self-Review (Part 1)**

---

Try to answer these questions by yourself to see if you understood the information.

1. What is a pathogen?
2. List the 4 ways a BSF removes pathogens and dirt from water.
3. What is the biolayer?
4. What should you do if you only have very dirty water and want to pour it into a BSF?
5. What is the most important part of a BSF?
6. List the 8 key filter performance points you can check to see if a BSF is treating water well.



## **PART 2: BIOSAND FILTER CONSTRUCTION MANUAL**

## BSF Construction Process

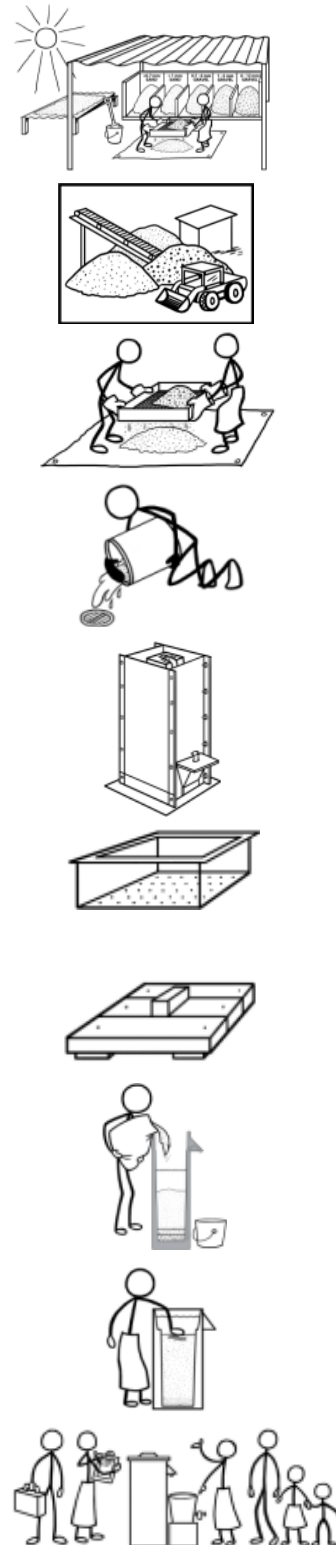
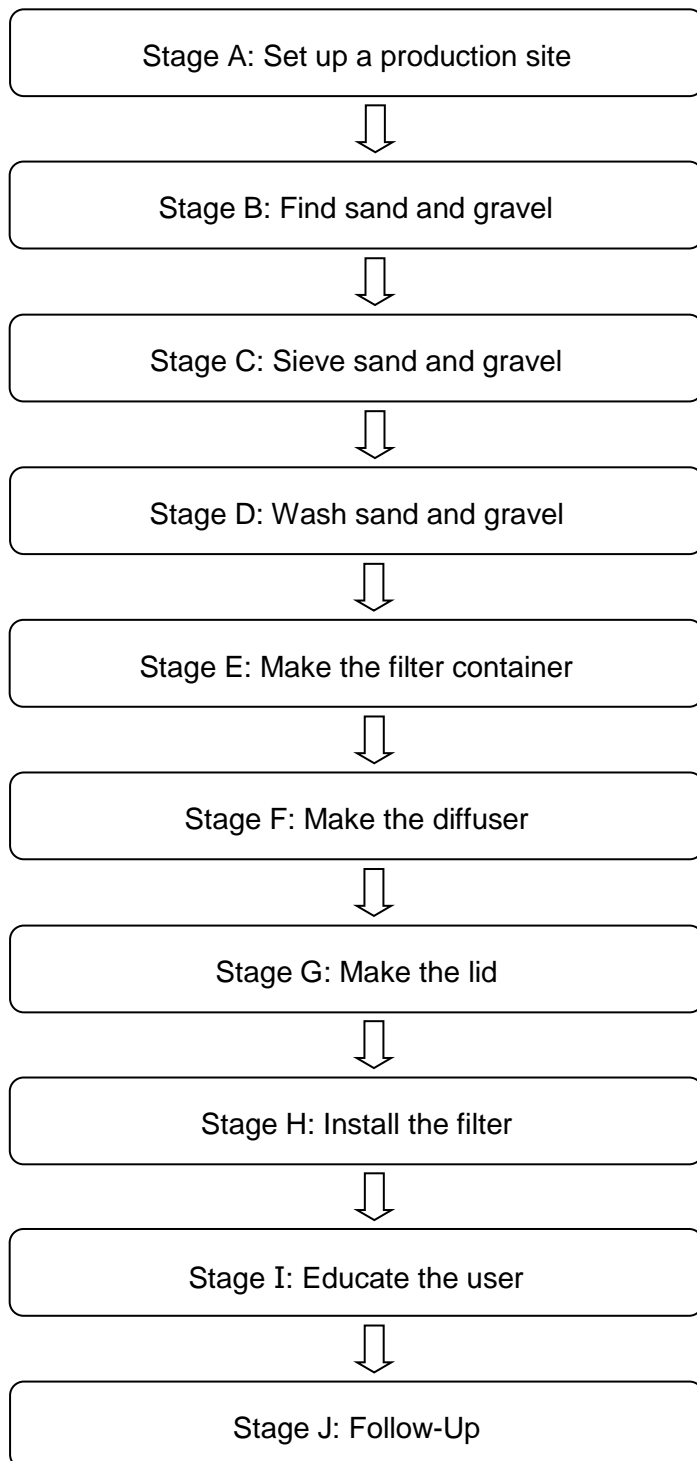

## Construction Safety

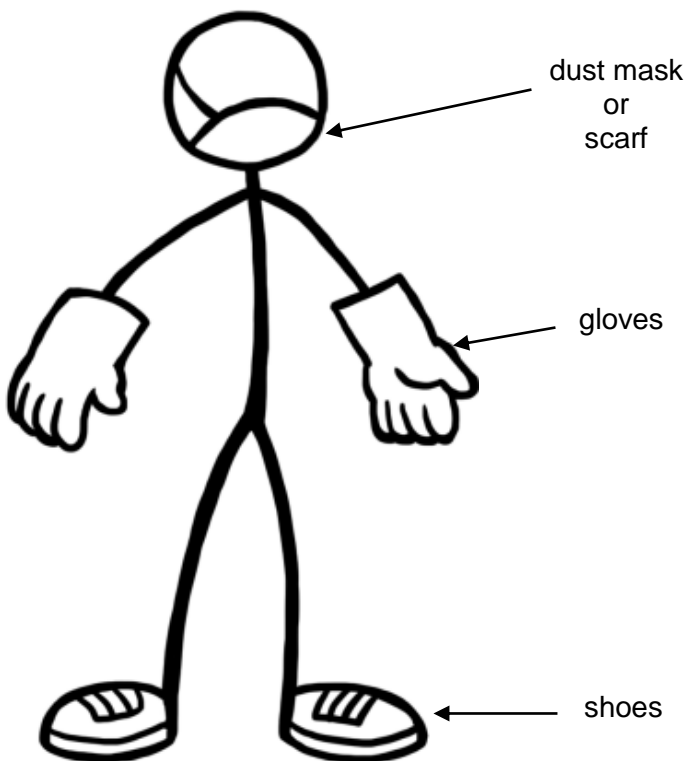

Make sure everyone knows where the FIRST AID KIT is located.  
At the very least, the kit should contain bandages, gauze and disinfectants.



Make sure everyone knows WHO TO CALL in an emergency.



**WARNING:** Cement can burn your skin. Do not touch cement with bare hands!





**FILTERS ARE VERY HEAVY!**

- Be careful of toes and fingers.
- Wear shoes.
- Lift with your knees, not your back.

## Working with Cement

Cement can hurt you if it comes into contact with your skin, eyes, or if you inhale it (breathe it in).. Cement usually contains a metal called hexavalent chromium. This metal causes allergic dermatitis, or inflammation of the skin.

When you empty a bag of cement, the dust can irritate your skin. The dust reacts with body sweat or damp clothing to form a solution that can burn you. Cement dust can also get in your eyes, causing redness, burns, or blindness. Inhaling cement dust irritates your nose and throat. It can also cause choking and difficulty breathing. Cement is also hazardous when it is wet - in mortar or concrete. If it gets inside your boots or gloves, or soaks through your clothes, it can cause burns and skin ulcers. The burns caused by cement may be slow and you may not feel anything for several hours. That is why it is important to wash cement off your skin right away.

### What to wear:

- Eye protection for mixing, pouring, and doing other work with dry cement
- A face mask to prevent inhaling cement dust
- Gloves
- Long sleeves and full-length pants
- Pull sleeves over gloves
- Tuck pants into boots when working with wet mortar or concrete

### What to do:

- Work upwind from cement dust
- Remove rings and watches because cement dust can collect underneath them and burn your skin
- Remove any clothing contaminated by cement
- **If your skin comes in contact with cement, wash with cold running water as soon as possible.** Flush out any open sores or cuts. Get medical attention if your skin still feels like it is burning.
- After working with cement, always wash your hands before eating, smoking, or using the toilet
- **If your eyes are exposed to cement, rinse with cold clean water for at least 15 minutes.** Get medical attention if necessary.

## Tools and Materials Required to Make and Install BSFs

### Technicians' Gear



Shoes



Gloves



Dust mask  
or scarf



Rubber gloves  
(optional)



Monitoring forms

### Tools and Equipment

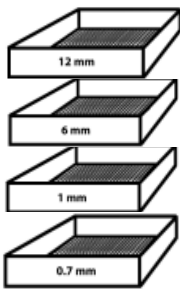

Sieves (4 sizes):  
12 mm ( $\frac{1}{2}$ " )  
6 mm ( $\frac{1}{4}$ " )  
1 mm (0.04" )  
0.7 mm (0.03" )

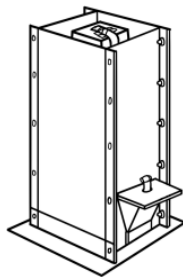

Steel Mold(s)



Water and  
drain(s)



Storage areas for sieved  
and washed/bagged sand

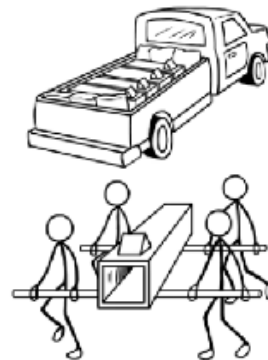

Transport for filters  
and installation  
materials



Wheelbarrow (Optional)

## Tools and Materials Required to Make and Install BSFs

### Tools and Equipment –Continued



Shovel(s)



Trowel(s)



Rubber or wood mallet(s)



Wrench(es)  
(15 mm or  $\frac{9}{16}$ " )



Wrench  
(38 mm or 1  $\frac{1}{2}$ " )



Metal or wood bars



Wood bar or leveling stick



Level



Tape measure or ruler



Wire brush, sand paper or steel wool



Washing brush



Large buckets for washing sand and gravel, holding water



Small buckets for measuring and moving sand, gravel and cement



Scissors or utility knife



Paint brush or cloth



Tarps or plastic sheets



Measuring container or old bottle to measure flow rate



Stopwatch or timer



Hose that fits over outlet tube  
- inner diameter: 9 mm ( $\frac{3}{8}$ " )  
- length: 1 m (3 ft)



Funnel that fits into the 9mm (inner diameter)



Cloth for cleaning outlet tube



2 L bottle for checking source water turbidity



Clear jar with lid



Tire or bag of grain or rice (to help flip filters over)



4 Wood blocks



## Tools and Materials Required to Make and Install BSFs

### Consumable Items

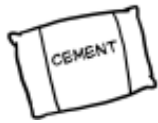

Cement

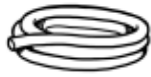

Outlet tube -  
Polyethylene or  
vinyl  
Inner diameter:  
6 mm ( $\frac{1}{4}$ " )  
Outer diameter:  
9 mm ( $\frac{3}{8}$ " )

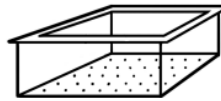

Diffuser(s)



Lid(s)



Sand and gravel  
(mixed or separate)  
suitable for filtration  
material



Sand and gravel  
(mixed or separate)  
suitable for concrete  
construction



Tape  
(duct tape or  
other very  
sticky tape  
preferred)



Cooking oil, butter,  
margarine or lard



Soap



1 L bottle  
to take to  
installations



Chlorine  
(example: 5.25%  
bleach)



Bags  
(optional) to  
hold about  
30 litres or  
27 quarts of  
washed  
filtration  
sand



Bags  
(optional) to  
hold about  
 $3 \frac{1}{4}$  litres or  
3 quarts of  
washed  
separation  
gravel



Bags  
(optional) to  
hold about  
3 litres or  
2.7 quarts  
of washed  
drainage  
gravel



Paint  
(or ceramic tiles,  
or other material  
to finish exterior  
of filters)



Educational materials,  
stickers and/or brochures  
to leave with users

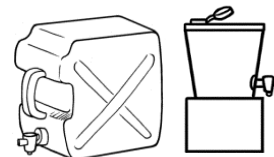

Safe water storage  
containers for users

## Summary of Material Quantities to Make 1 Biosand Filter

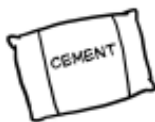

Cement

12 litres  
(11 quarts)



Construction sand (<1 mm)

24 litres  
(22 quarts)



Small gravel (1-6 mm)

12 litres  
(11 quarts)



Large gravel (6-12 mm)

12 litres  
(11 quarts)



Water

7-10 litres  
(2-3 gallons)



Washed filtration sand (<0.7mm)

30 litres  
(27 quarts)



Washed separation gravel (0.7-6mm)

3 <sup>1</sup>/<sub>4</sub> litres  
(3 quarts)



Washed drainage gravel (6-12mm)

3 litres  
(2.7 quarts)



Outlet tube - Polyethylene or vinyl

Inner diameter: 6 mm (<sup>1</sup>/<sub>4</sub>" )

Outer diameter: 9 mm (<sup>3</sup>/<sub>8</sub>" )

Length: 105 cm (41" )

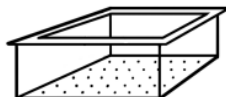

1 Diffuser

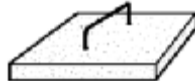

1 Lid

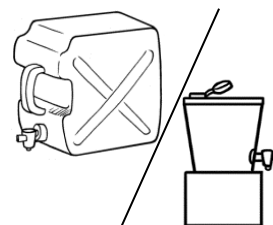

1 Safe water storage container

## Stage A: Set Up a Production Site



## Stage A: Set Up a Production Site

---

You will need a work space to make biosand filters. The place where you make filters and prepare the sand and gravel is called the Production Site.

How much space you need depends on how many filters you will make. You could also have an office at the same location.

These are the things you need to think about when you are looking for a production site and setting it up.

### You will need...

- Covered areas to work in the shade
- Areas to mix concrete, store filters, and paint filters
- An area to sieve and wash sand
- Access to water (tap or pump)
- Drains for wastewater
- Road access
- Toilets and hand washing facilities
- Somewhere to lock up valuable tools and supplies, such as a storage room or shed
- Electricity (optional) - if you need lights or if you will be using power tools or electric vibrators. This is a decision you can make if you are making a lot of filters for a big project.

## Stage A: Set Up a Production Site

### You will need...

#### Area for Sieving Sand and Gravel

- Covered area to store un-sieved sand and gravel
- Raised table or platform in the sun to dry sand for sieving
- Covered area to sieve sand and gravel
- Tarp or concrete floor to sieve sand and gravel on top of
- Covered areas to store sieved sand and gravel

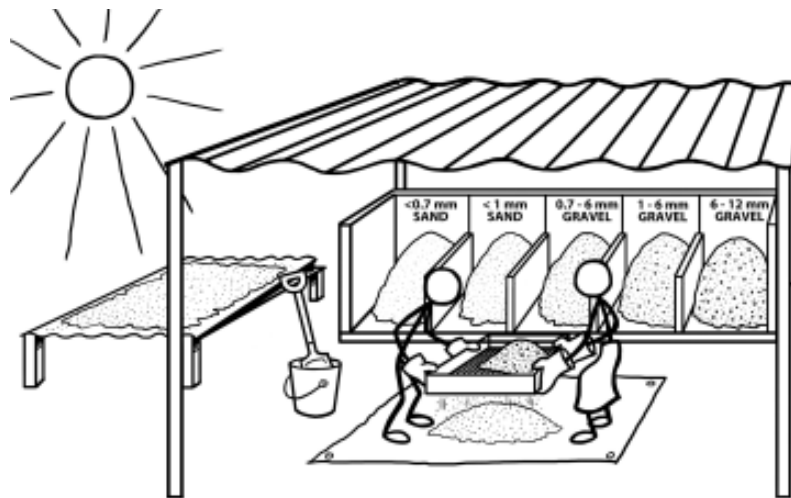

#### Area for Washing Sand and Gravel

- Covered area to wash sand and gravel
- Covered area to store washed sand and gravel
- Covered area to put washed sand and gravel in bags
- Covered area to store bags of sand and gravel ready for delivery
- Water source and drain
- Located near the piles of sieved sand and gravel



## Stage A: Set Up a Production Site

### You will need...

#### Filter Pouring Area

- Floor space for mixing concrete
- Area to pour filters, let them stand for 24 hours and de-mold filter
- Located near water source and drain

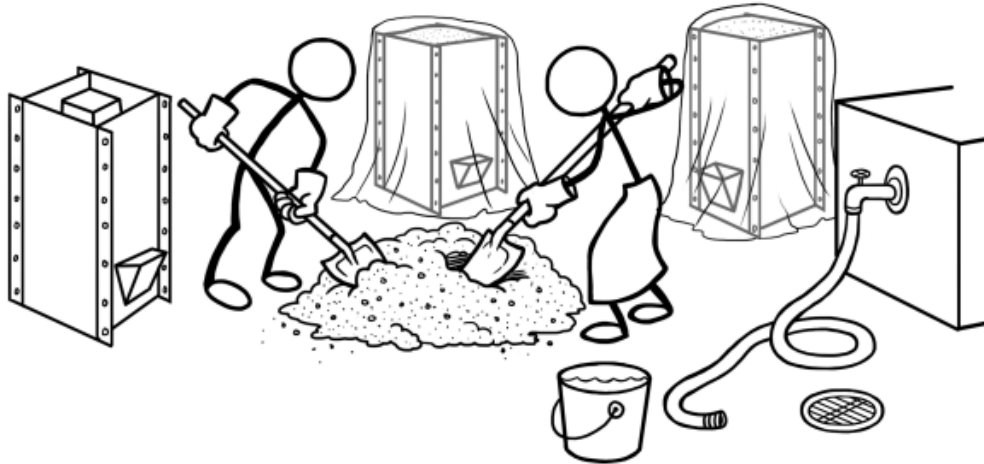

#### Filter Finishing Area

- Area to fill the filters with water and to let the filters cure for 5 to 7 days
- Area to clean filters
- Area to store clean filters ready to be painted
- Area to paint filters
- Area to store painted filters ready for delivery
- Water source and drain

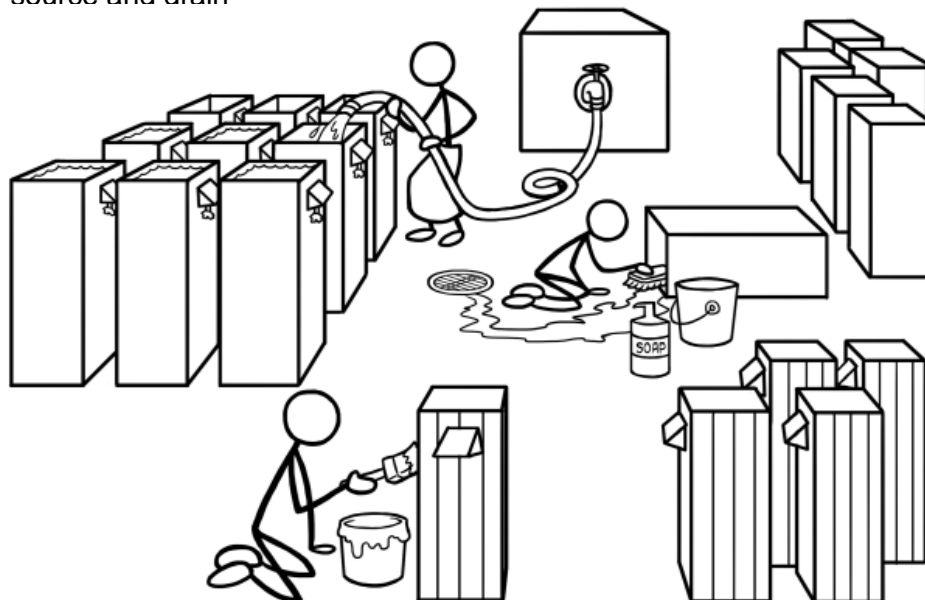

## Stage A: Set Up a Production Site

---

### You will need...

Locked Storage Area for valuable items

- Storage area with walls, a roof and a door with a lock

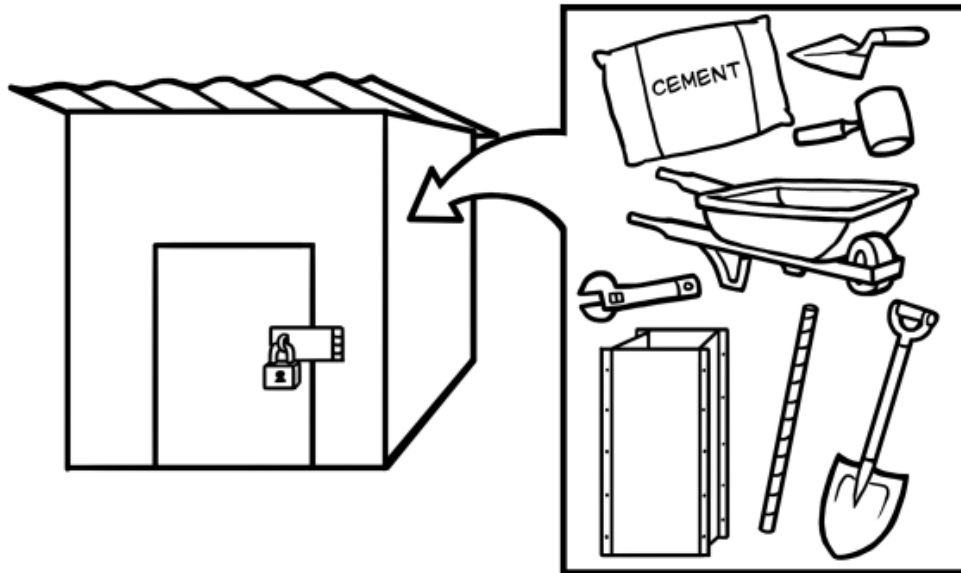

Latrines with hand washing

- Optional: an area for technicians to change clothes

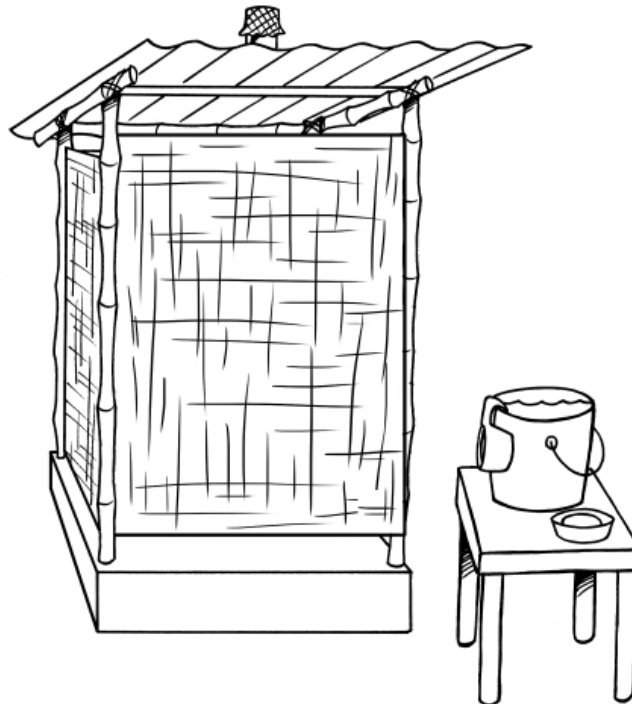





## Stage B: Find Sand and Gravel

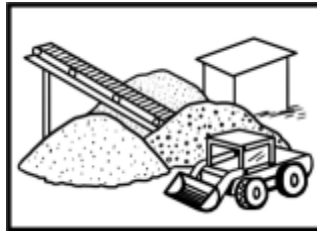

## Stage B: Find Sand and Gravel

Selecting and preparing the filtration sand and gravel is very important for the treatment efficiency of the biosand filter. While not complicated, the steps in preparing the filtration sand must be followed exactly as presented. Poor selection and preparation of the filtration sand could lead to poor performance and a lot more work to fix the problem.

### 1. What kind of sand do I need?

Sand with MANY DIFFERENT GRAIN SIZES, and CLEAN with no leaves, sticks, or salt.

### 2. Where can I find sand?

#### #1 ROCK CRUSHER

Sand and gravel from a rock crushing machine is called crushed rock. Crushed rock has a good mixture of grain sizes, which is important for proper functioning of the filter. It is also less likely to be contaminated by pathogens or organic matter.

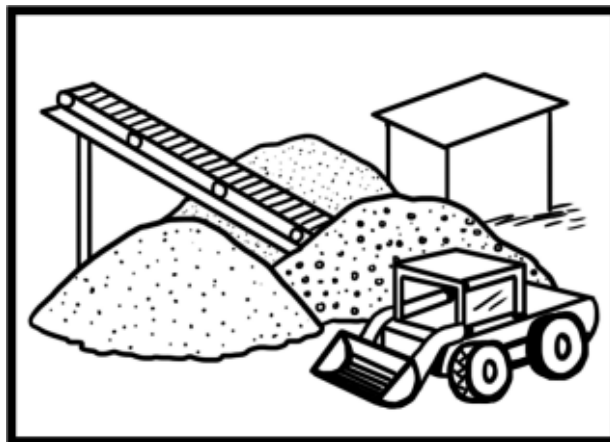

Crushed rock is the BEST sand and gravel to use for inside the filter. You can also use it for the concrete.

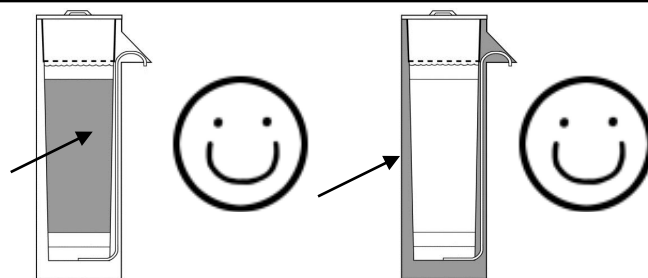

Gravel pits or quarries are the best places to obtain crushed rock, and are common in most parts of the world. You can also ask local construction, road work, or concrete manufacturing companies where they get their crushed rock.

At first, quarry rock may not seem proper for sieving because of the large amounts of dust. You need to select the rock load and the crusher properly to make sure that there are not a lot of large chunks of rock and dust.. Often, you can even sieve the load at the quarry site and only pay for what you take. This greatly reduces the waste and cost.

Crushed rock may be difficult to locate, more expensive, and require transportation to your production site. However, it is critical in providing the best water quality and is worth the extra time, effort and cost.



**Tip:** CAWST is aware of crushed rock sources in many countries. If you have trouble finding a local source, please contact CAWST and we may be able to connect you with a source already being used by other projects..

## Stage B: Find Sand and Gravel

### #2 SAND QUARRY

If crushed rock is absolutely not available, the next choice is sand from a sand quarry or pit. Sometimes you can get gravel there too. It is usually not as clean as crushed rock – it may be contaminated with pathogens or organic matter.

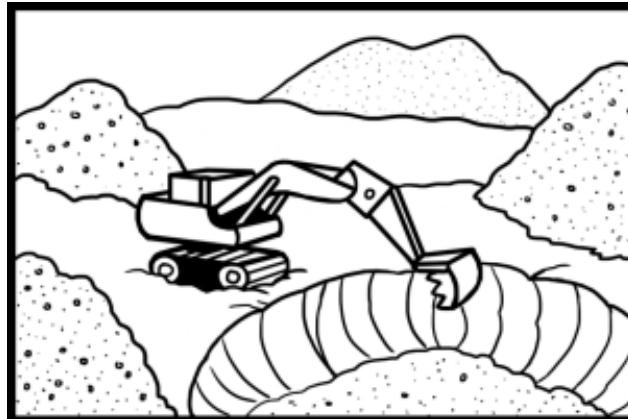

Use quarry sand if you cannot find crushed rock. Check to make sure the sand has a variety of grain sizes and that it is clean.

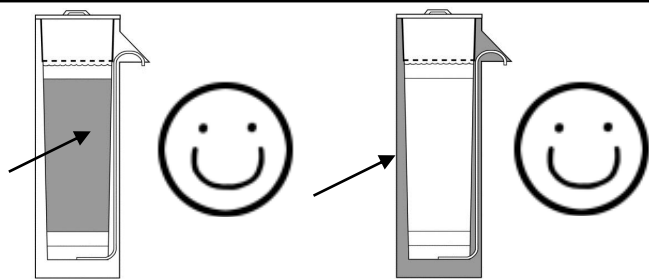

### #3 RIVER

The sand and gravel from a river are not clean. They have dirt, leaves and sticks, and pathogens in them. If you use river sand, it takes more work to make it clean.



You can use river sand to make the concrete filter container. River sand is not good sand for inside the filter.

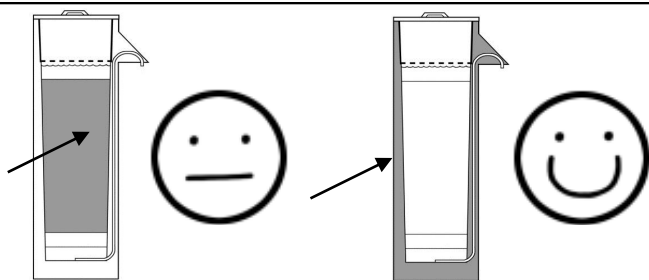

## Stage B: Find Sand and Gravel

### #3 River –Continued –

Try to find quarry sand and gravel for inside the filter. If you have to use river sand, use sand from high up the side banks of the river - not from the bottom of the river. Sand from the banks has less pathogens in it and may have a better mixture of grain sizes.

**River sand is usually contaminated with pathogens (from human and animal fecal matter) and contains organic material (e.g. leaves, sticks).** Putting contaminated sand in the biosand filter may actually result in worse water quality than the original source water used. This happens because the organic matter is a food source for pathogens and helps them to grow and multiply in the filter until all of the food is consumed.

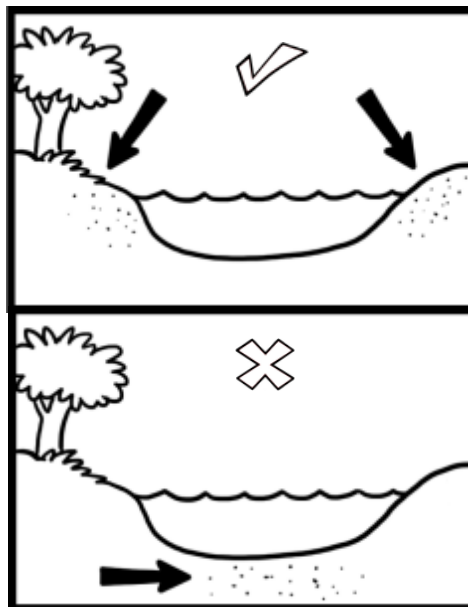

River sand is almost always contaminated with fecal matter (pathogens) and organic matter. The organic matter provides food for bacteria, and may encourage bacteria to grow deep inside the filter. The pathogens can be removed from the sand through a disinfection method (laying it out in the sun or chlorinating it). However, the organic matter can only be removed from the sand by heating the sand to very high temperatures to burn off the organic material. This process is very costly, time consuming and not practical in most situations. For these reasons, it is better to spend your time and money to find a source of crushed rock that provides the best water quality.



Crushed rock makes the best filtration sand. It may be hard to find and it may be more expensive than river sand. But you should use crushed rock!

If crushed rock is very expensive, buy crushed rock to use only for the sand and gravel inside the filter. You can buy river sand and construction gravel to make the concrete filter container.

## Stage B: Find Sand and Gravel

### #4 BEACH

Beach sand is well sorted – it does not have many different grain sizes. It also has organic matter and dirt in it, so it takes a lot of work to make it clean. There is also salt stuck to the sand. This makes the filtered water taste salty at the beginning.

You have to flush the beach sand with fresh water to remove the salt and other contaminants.



Don't use beach sand for the sand inside the filter or to make the filter container.

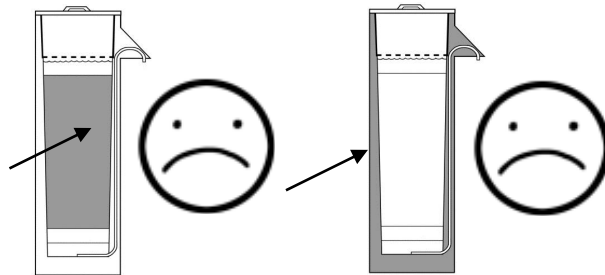

### #5 DESERT

Sand from the desert does not have many different sizes. It is not very good sand to use.

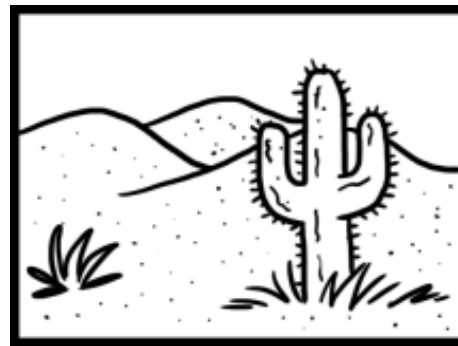

Don't use desert sand for the sand inside the filter or to make the filter container.

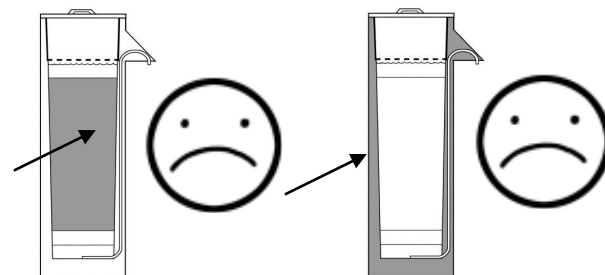



**TIP:** You can buy sand from one place, and gravel from another place. Often you buy sand and gravel mixed together.

## Stage B: Find Sand and Gravel

When you are selecting a source for filtration sand, also take into consideration the tips in the table below.

### Things to Look for when Selecting Sand for Inside the Filter

|    |   |
|---|--|
| <ul style="list-style-type: none"> <li>• When you pick up a handful of the sand, you should be able to feel the coarseness of the grains.</li> <li>• You should be able to clearly see the individual grains, and the grains should be of different sizes and shapes.</li> <li>• When you squeeze a handful of dry sand and then you open your hand, the sand should all pour smoothly out of your hand.</li> <li>• If you are buying mixed sand and gravel, it should have a lot of gravel pieces up to 12 mm (½”) in diameter.</li> </ul> | <ul style="list-style-type: none"> <li>• It should <b>NOT</b> contain any organic material (e.g. leaves, grass, sticks, loam, dirt).</li> <li>• It should <b>NOT</b> contain possible microbiological contamination.</li> <li>• It should <b>NOT</b> be from an area that has been used a lot by people or animals.</li> <li>• It should <b>NOT</b> be very fine sand nor sand that is mostly silt and clay.</li> <li>• When you squeeze a handful of dry sand, it should <b>NOT</b> ball up in your hand or stick to your hand. If it does, it probably contains a lot of dirt or clay.</li> <li>• It should <b>NOT</b> have much gravel larger than 12 mm (½”). Any gravel larger than 12 mm (½”) is waste and will not be used inside the filter or in the concrete.</li> </ul> |



**TIP:** A sand grain size analysis kit and spreadsheet is also available to help you select the best possible filtration sand,. If you analyse the grain size, it helps make sure that the sand has an appropriate range of grain sizes.

Contact CAWST for more information: [cawst@cawst.org](mailto:cawst@cawst.org).

### 3. Dry the sand and gravel

When the sand and gravel is delivered to your production site, you need to dry it and store it until you are ready to sieve it.

- If the sand is wet, dry it.
- Spread the sand very thinly on a platform or table that is up above the ground. Turn it with a shovel sometimes so it all gets very dry.
- Be careful the sand does not get dirty. Dirt and leaves can blow into the sand while it is drying.
- Store the dry sand where it will stay dry and clean.

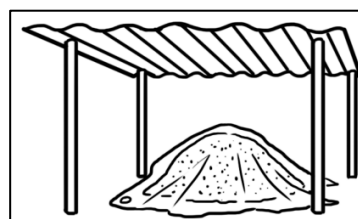
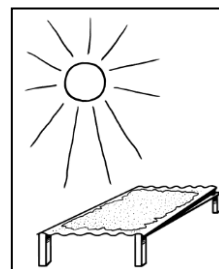

## Stage C: Sieve the Sand and Gravel



## Stage C: Sieve the Sand and Gravel

### 1. Concrete sand and gravel (for making the container)

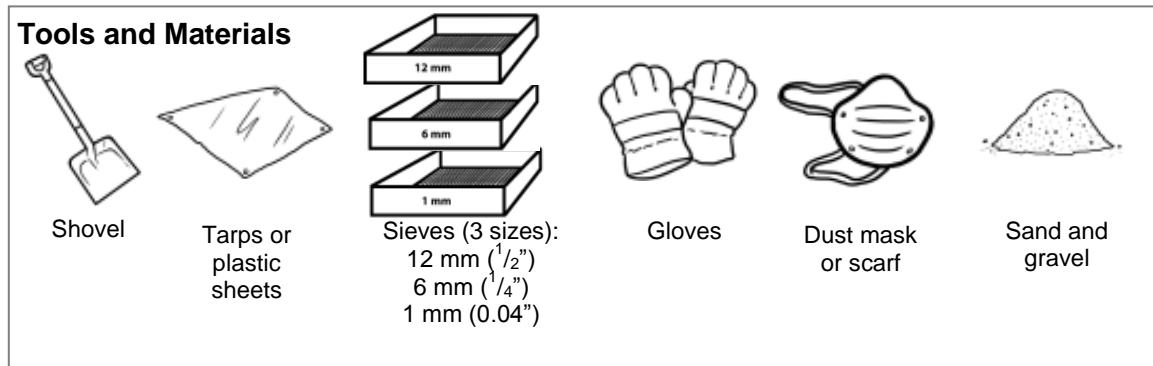

- Put the sand and gravel through the 12 mm ( $\frac{1}{2}$ " ) sieve. **Throw away any rocks that stay on top of the 12 mm sieve**—they are too big to use in the biosand filter.

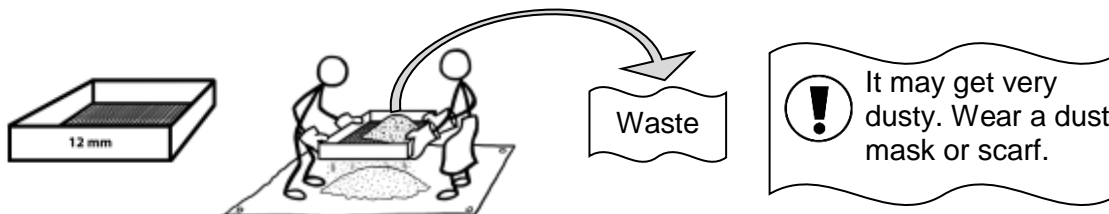

- Pick up all the material that went through the 12 mm sieve. Put it through the 6 mm ( $\frac{1}{4}$ " ) sieve. **Store all the gravel that stays on top of the 6 mm sieve in the 6-12 mm gravel storage pile.** This pile is used for two things: large gravel when you make the concrete, and drainage gravel that goes inside the filter.

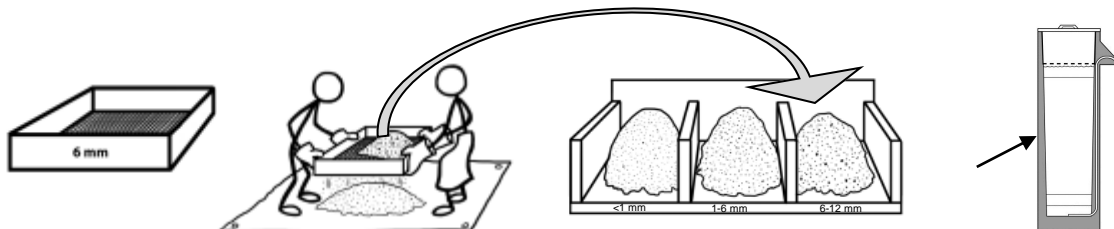

- Pick up all the material that went through the 6 mm sieve. Put it through the 1 mm (0.04" ) sieve. **Store all the gravel that stays on top of the 1 mm sieve in the 1-6 mm gravel storage pile.** Use this small gravel for making concrete.

- Store all the sand that fell through the 1 mm sieve in the <1 mm sand storage pile.** Use this sand for making concrete.

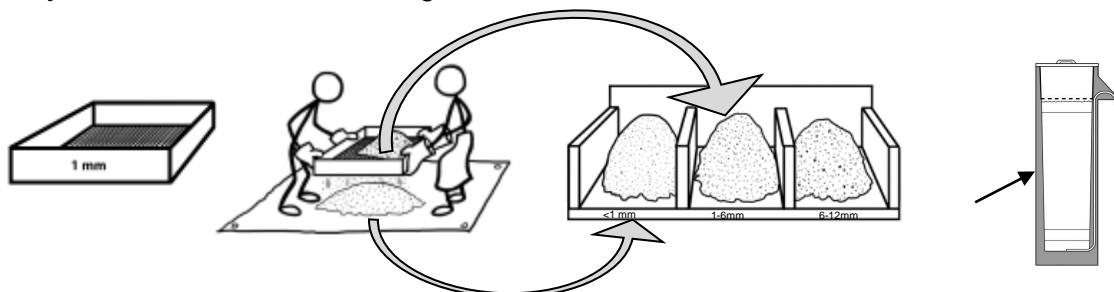



## Stage C: Sieve the Sand and Gravel

### 1. Concrete sand and gravel –Continued

Recommended Sources:

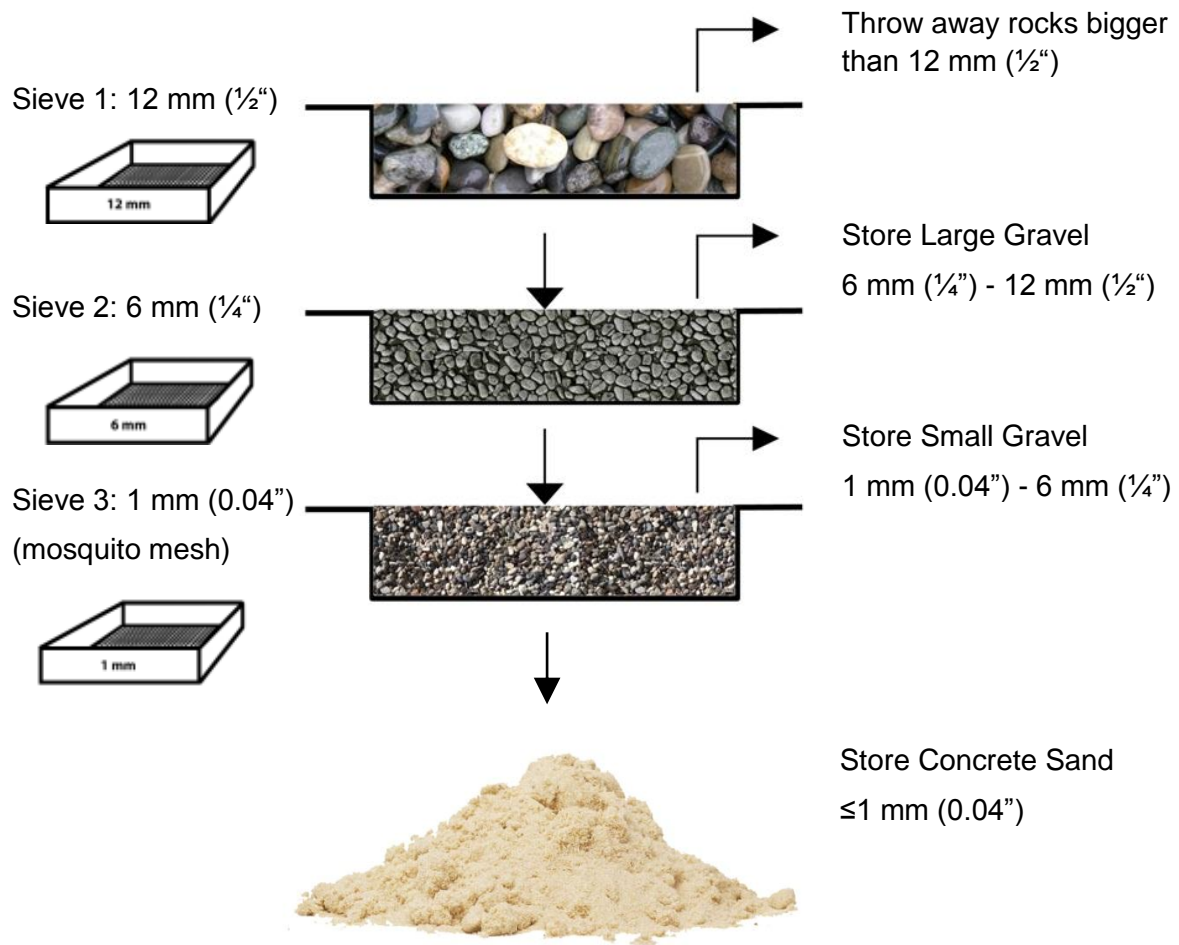

## Stage C: Sieve the Sand and Gravel

### 2. Filtration sand and gravel (for inside the filter)

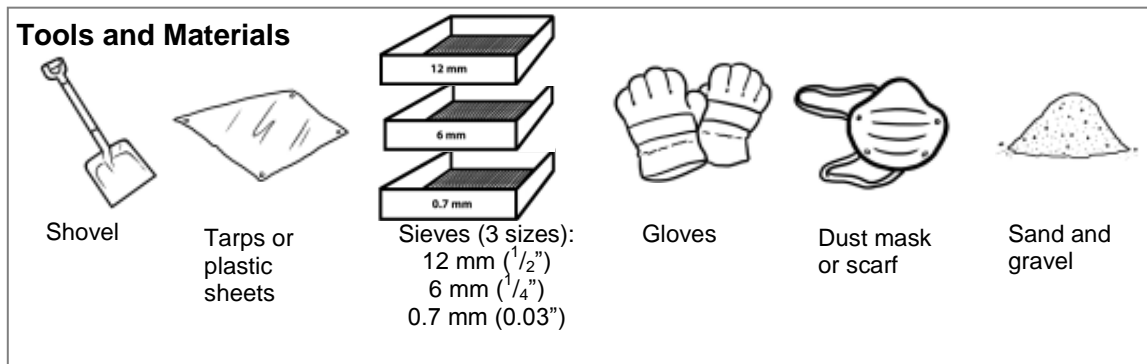

- Put the sand and gravel through the 12 mm ( $\frac{1}{2}$ " ) sieve. **Throw away any rocks that stay on top of the 12 mm sieve**—they are too big to use in the biosand filter.

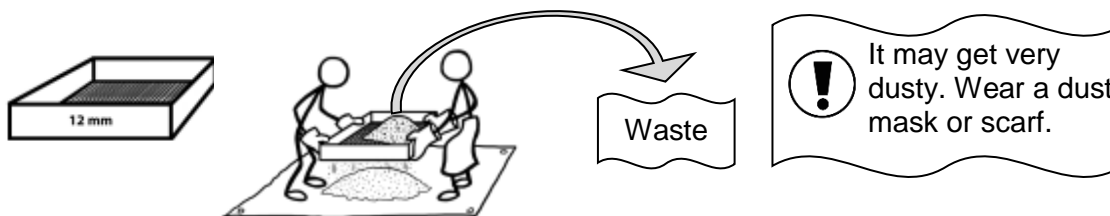

- Pick up all the material that went through the 12 mm sieve. Put it through the 6 mm ( $\frac{1}{4}$ " ) sieve. **Store all the gravel that stays on top of the 6 mm sieve in the 6-12mm gravel storage pile.** This pile is used for two things: large gravel when you make the concrete and drainage gravel that goes inside the filter.

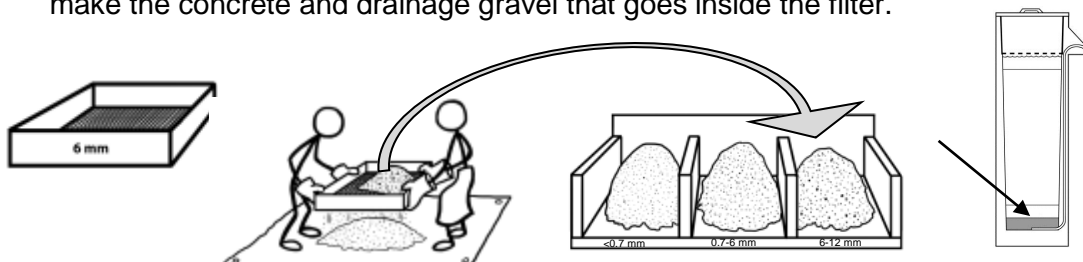

- Pick up all the material that went through the 6 mm sieve. Put it through the 0.7 mm (0.03") sieve. **Store all the gravel that stays on top of the 0.7 mm sieve in the 0.7-6mm gravel storage pile.** This is the separation gravel for inside the filter.

- Store all the sand that fell through the 0.7 mm sieve in the <0.7 mm sand storage pile.** This is the filtration sand for inside the filter.

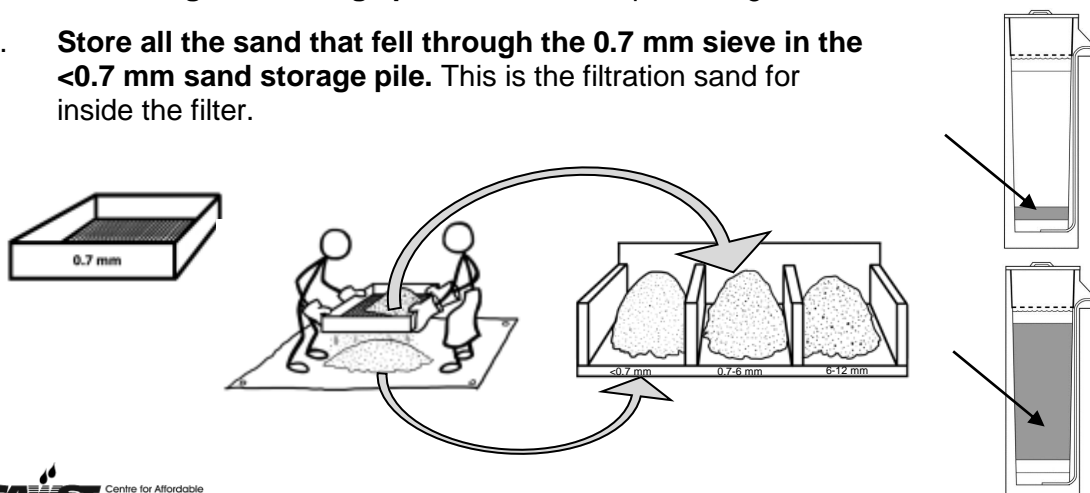

## Stage C: Sieve the Sand and Gravel

### 2. Filtration sand and gravel (for inside the filter) –Continued–

Recommended Sources:

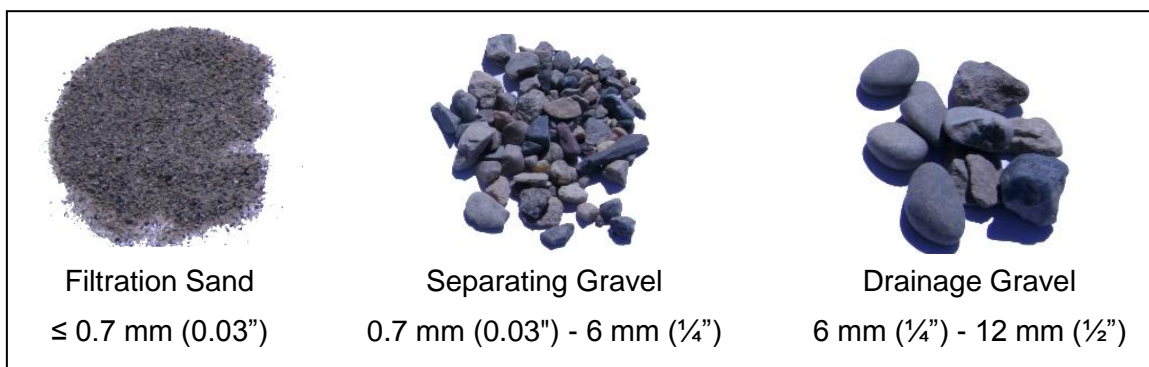
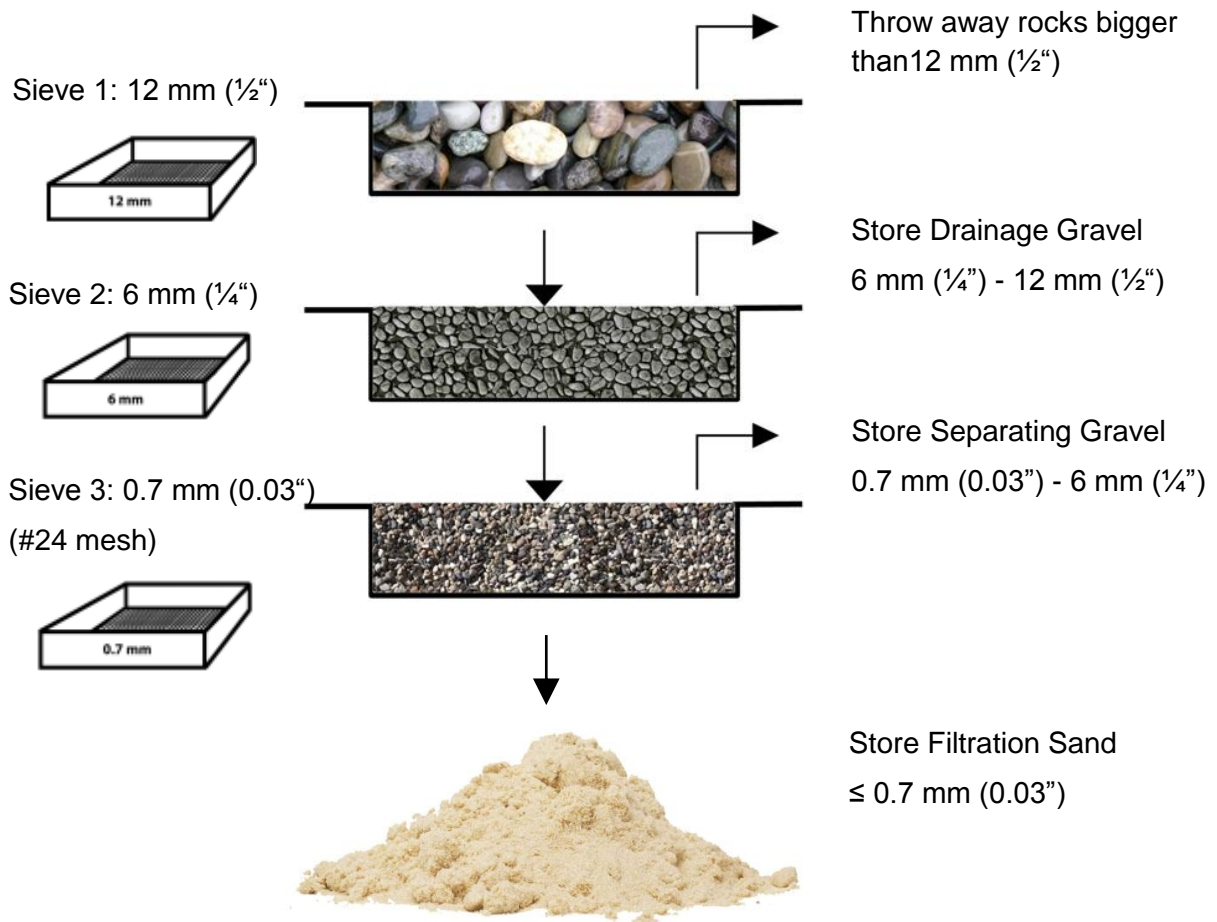
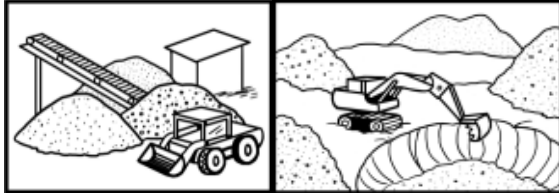

## Stage C: Sieve the Sand and Gravel

### 3. Sieve options

You can make good sieves in a few different ways. These are some examples of different types of sieves:

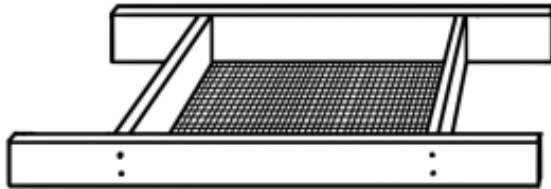

Requires 2 people for sieving.

Requires 1 person for sieving.

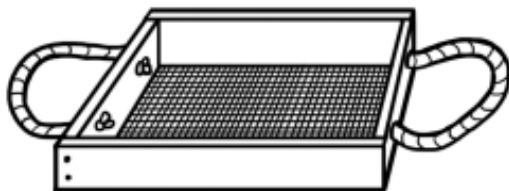

Requires 2 people for sieving.

Requires 1 person for sieving.



With this method, it is difficult to keep the sieved sand separate from the un-sieved sand. You must be very careful. Collect the sieved sand in a box. Be careful when lifting the sieve up so no un-sieved sand falls into the box.

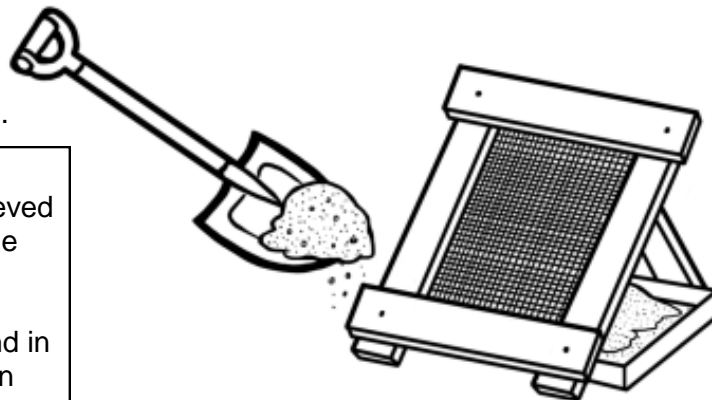

## Stage C: Sieve the Sand and Gravel

### 4. Tips for sieving the sand and gravel

- Dry sand completely before sieving. Wet sand will not go through the sieve.

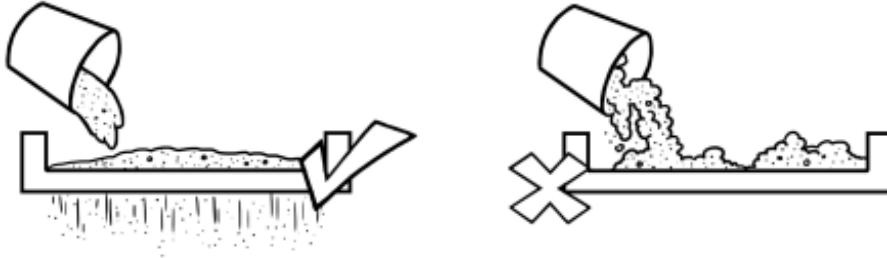

- The sand must be clean. Use sand with no pieces of grass, leaves, sticks or other material in it.

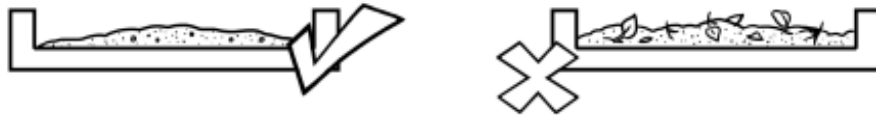

- Don't pile too much sand on the sieve. It will break the sieve.

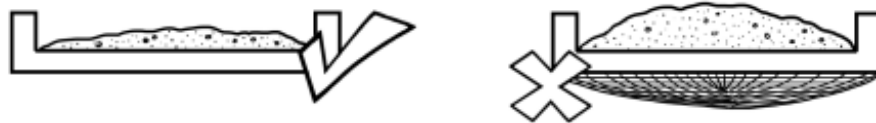

- Keep sieving until very little or no sand falls through the sieve. If there is still a lot of sand that falls through, keep sieving.

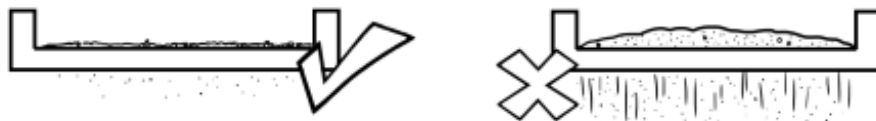

- Repair sieves when they break. The wires in the mesh should be evenly spaced and the holes all the same size. Do not use broken sieves.



## Stage C: Sieve the Sand and Gravel

---

- Wet sieving is a process that can be used if the sand cannot be dried. It uses water to force or wash the sand through the sieve. It requires a large amount of clean water.
- Depending on the source of your sand and gravel, the sieving procedure described in this manual may be a little different. For example, if you get filtration sand and gravel and concrete sand and gravel all from the same source, you may want to sieve all of the material through the 12 mm and 6 mm sieves, then put some of the sand through the 1mm sieve and the rest of the sand through the 0.7mm sieve.
- No matter how you sieve the sand and gravel, there are two important factors:
  1. You must end up with filtration and construction materials that are the proper sizes, as listed in this manual.
  2. Your filtration sand and gravel is good quality and not contaminated with pathogens, chemicals, human waste or organic material such as leaves. .



## Stage C: Sieve the Sand and Gravel

### 5. Store the sieved sand and gravel

- Store the piles of sieved sand and gravel where they will stay clean and dry.
- Make sure you keep your piles tidy and separate so that they do not mix with each other or with un-sieved sand. Poor sand quality, due to stray rocks and mixed sand sizes, will reduce the treatment efficiency of the filter. If this happens, you will have to sieve the sand again.

#### Concrete Sand and Gravel

You need piles of material that will go into the concrete:

- Sand (<1 mm) (<0.04")
- Small gravel (1-6 mm) (0.04-1/4")
- Large gravel (6-12 mm) (1/4-1/2")

#### Filtration Sand and Gravel

You need piles of material that will go inside the filter:

- Sand (<0.7 mm) (<0.03")
- Separating gravel (0.7-6 mm) (0.03-1/4")
- Drainage gravel (6-12 mm) (1/4-1/2")



This gravel is the same size — it can all go in 1 pile.

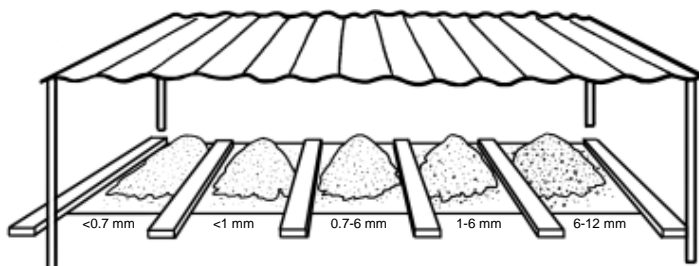

Simple storage area: Piles of sand and gravel are separated by pieces of wood. The ground is covered by a tarp or plastic sheet.

It is easy for sand and gravel to get mixed, so be very careful.

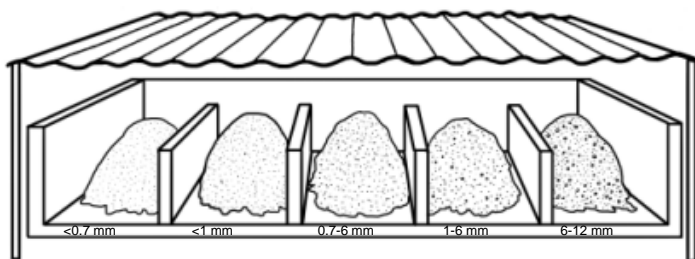

Improved storage area: Piles of sand and gravel are separated by tall concrete walls. Floor is concrete.

This storage area helps to keep the piles separated.

- You do not have to store all the sand and gravel piles in the same location. You can store the concrete sand and gravel near the filter pouring area, and the filtration sand and gravel near the area for washing sand and gravel.



Fill out the monitoring form for Sand and Gravel Preparation (Appendix 1)





## Stage D: Wash the Filtration Sand and Gravel

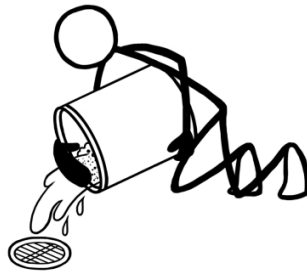

## Stage D: Wash the Filtration Sand and Gravel

**Tools and Materials**





Buckets      Water and drain      Rubber gloves (optional)      Clear jar with lid      Filtration sand (<0.7 mm)      Separating gravel (0.7-6 mm)      Drainage gravel (6-12 mm)

### 1. Wash the separation and drainage gravel (for inside the filter)

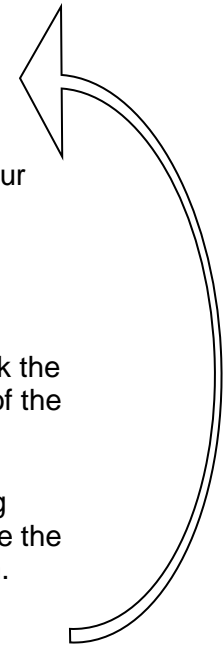

1. Put some sieved separation gravel or drainage gravel in a bucket.
  2. Fill the bucket half full with clear water.
  3. Swirl the gravel around in the water using your hand or a clean stick or spoon.
  4. Dump the water out of the bucket. Hold back the gravel with your hand so it does not fall out of the bucket.
- Pour the water down a drain or into a settling tank. If you use a settling tank, you can reuse the water when the dirt has settled to the bottom.
5. Repeat steps 2, 3 and 4 until the gravel is completely clean and the water you dump out is clear.



 Wash gravel until it is completely clean.



6. Fill out the monitoring form for Sand and Gravel Preparation (Appendix 1).
7. Store cleaned gravel in a dry, clean place. Or dry it and then put it in bags ready to take for installation. For one filter, you will need a bag with about 3 L of washed drainage gravel (or about 2.7 quarts), and another bag with about 3 1/4 L of separation gravel (or about 3 quarts).

## Stage D: Wash the Filtration Sand and Gravel

### 2. Wash the filtration sand (for inside the filter)



1. Put some sieved filtration sand in a bucket. This is sand that has gone through the 0.7 mm (0.03”) screen.
2. Fill the bucket half full with clear water.
3. Swirl the sand around in the water using your hand or a clean stick or spoon.
4. Dump the water out of the bucket. Hold back the sand with your hand so it does not fall out of the bucket.  
  
Pour the water down a drain or into a settling tank. If you use a settling tank, you can reuse the water when the dirt has settled to the bottom.
5. Repeat steps 2, 3 and 4 a few times. Count how many times you wash the sand.



The water you dump out of the bucket should still be a little dirty when you finish washing the sand.



**DO NOT** wash the sand until it is completely clean!



#### HOW DO I KNOW IF THE SAND IS WASHED ENOUGH?

1. Do a jar test (optional).
2. Install a filter and check the flow rate.



When you are more experienced at washing sand, you will be able to tell quickly if the sand has been washed enough. But every load of sand you buy will be different. Always check the washed sand by doing a trial filter installation (described 2 pages later) once for every truck load of sand you get.

## Stage D: Wash the Filtration Sand and Gravel

### 2. Wash the filtration sand (for inside the filter) –Continued

#### Check the sand: Do a jar test (Optional)

After you have washed the sand 3 or 4 times, do a jar test. This is one way to find out if you need to wash the sand more.



1. Put a little sand in the bottom of a clear jar.



2. Fill the jar with water. Put on the lid.



3. Shake the jar.



4. Stop shaking the jar. Wait 4 seconds.

5. After 4 seconds, look into the side of the jar.

If you can not see the top of the sand, it is too dirty. Keep washing the sand. Do another jar test after 1 or 2 more washes.



If you can see the top of the sand but not clearly, it is good.

Wash the rest of the sand the same number of times.



If the water is clear or almost clear and you can see the top of the sand very easily, the sand is too clean. It has been washed too much. Throw the sand away.

Start again, and wash the new sand fewer times before doing a jar test.



6. Fill out the monitoring form for Sand and Gravel Preparation (Appendix 1).

## Stage D: Wash the Filtration Sand and Gravel

### 2. Wash the filtration sand (for inside the filter) –Continued

#### Check the sand: Install a test filter and check the flow rate

To make sure the sand will work well in the filters, install 1 filter and check the flow rate.

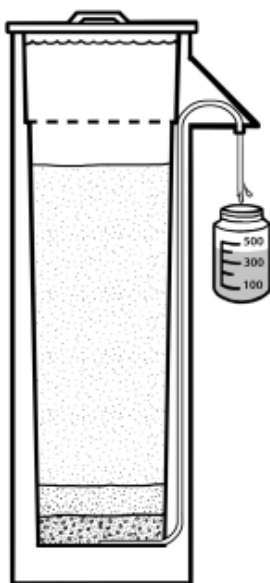

1. Install 1 filter with washed gravel and sand. (See Stage H: Install the Filter for instructions). This test is usually done at the filter production site.
2. Put a diffuser into the filter. Fill the filter with water.
3. Catch the filtered water in a container with marked measurements on it.
4. You should get 400 mL or less in 1 minute (13.5 US fluid oz).

Or, if you are filling a 1 litre bottle, it should take about 2 minutes and 30 seconds (or longer) to fill the bottle.

5. Check the flow rate against the boxes below. Change the number of times you wash the sand if you have to.

#### **Too Fast! Wash Less**

If the flow rate is over 450 mL per minute, the sand has been washed too much. Do not use this sand inside the filters. Try washing the sand less.

#### **400 mL/min Good**

If the flow rate is about 400 mL per minute, the sand is good. You can use this sand inside filters. Wash the rest of the sand the same number of times.

#### **Too Slow! Wash More**

If the flow rate is less than 300 mL per minute, it may be too slow for users. The filter will still be good for treating water, but people may not use it because it is too slow. Try washing the sand a little more.

*\*Note: If you are using older molds (Version 8 or 9), the flow rate should be 600 mL or less per minute.*



6. Fill out the monitoring form for Trial Installation (Appendix 1).

Every load of sand you buy will be different. Check every batch of sand by:

- washing enough sand for 1 filter,
- installing 1 filter and
- testing the flow rate.

This is an important test to make sure the filters will work well after you install them in the field.

## Stage D: Wash the Filtration Sand and Gravel

---

### 3. Store the filtration sand and gravel

#### Storing Washed Sand and Gravel

Store washed sand and gravel in a dry, clean place.

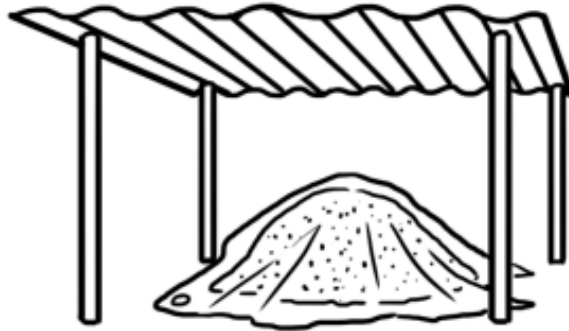

You can also store the washed sand and gravel in bags ready to take for installation. When you go to install filters, you will need to take 1 bag of sand, 1 bag of separation gravel and 1 bag of drainage gravel for each filter that you are going to install.

- Washed Sand: 30 L per bag (27 quarts)
- Washed Separation Gravel (0.7-6 mm): 3 1/4 L per bag (2.7 quarts)
- Washed Drainage Gravel (6-12 mm): 3 L per bag (3 quarts)



### Stage E: Make the Concrete Container

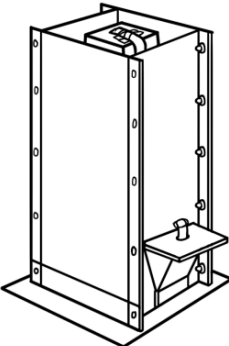

## Stage E: Make the Concrete Container

### 1. Prepare the mold

#### Tools and Materials



Wire brush,  
sand paper or  
steel wool



Wrench ( 15  
mm or  $\frac{9}{16}$ " )



Shoes



Level



Paint brush or cloth



Cooking oil, butter,  
margarine or lard



Tape



Outlet tube  
(105 cm or 41"  
long)

Inner diameter:  
6 mm ( $\frac{1}{4}$ " )

Outer diameter:  
9 mm ( $\frac{3}{8}$ " )

\*See note on  
next page

1. Scrub the steel mold to remove any old concrete. Use steel wool, a wire brush, or sand paper for metal.

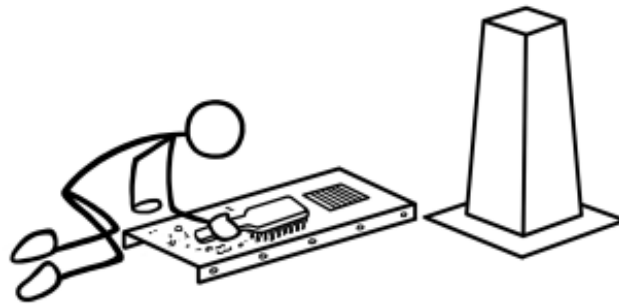

2. Paint all the inside walls of the mold with food oil, lard, butter or margarine. Use only edible oils, NOT motor oil.



Do NOT oil the top  
of the inside mold!  
If you do, the tubing  
will not stick.

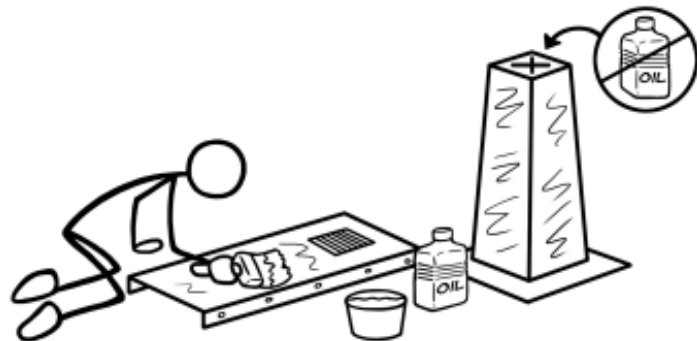

3. Put the mold together up-side-down. Tighten the bolts.

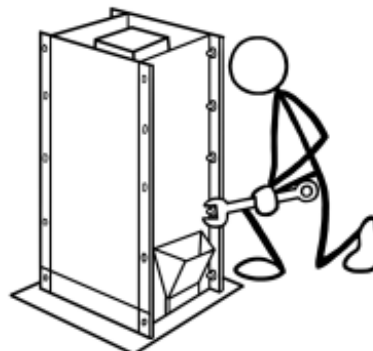



## Stage E: Make the Concrete Container

### 1. Prepare the mold –Continued

4. Cut a piece of tubing 105 cm long (41 inches).
5. Tape the tubing onto the top of the inside mold.
6. Put some tape over the end of the tube so it does not get plugged with concrete.

**Note:** Do **NOT** use plastic tubing with less than 6 mm ( $\frac{1}{4}$ " ) inner diameter (ID). If the inside area of the tubing has an ID of less than 6 mm ( $\frac{1}{4}$ " ), it will not get a good flow rate. If the pipe is crimped or if it gets blocked by the drainage gravel, the flow rate may also be low.

Do **NOT** use plastic tubing with an outer diameter (OD) of more than 9 mm ( $\frac{3}{8}$ " ). The walls of the concrete filter body are not very thick and the tube may stick out of the concrete if the OD is too large.

7. Now oil the top of the inside mold.
8. Put the nose cover plate on. Pull the tubing through the nose cover plate.



Make sure the tubing does not “kink” or pinch when you pull it through the nose cover plate!

9. Plug the end of the outlet tube with cloth, or cover it with tape, to make sure it does not get plugged with concrete.
10. Make sure the mold is level.



Make sure the mold is in the location where you want to pour the filter. Remember it will stay in this location for 6-24 hours while the concrete sets.

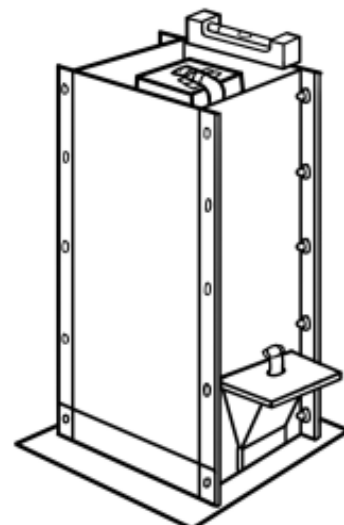
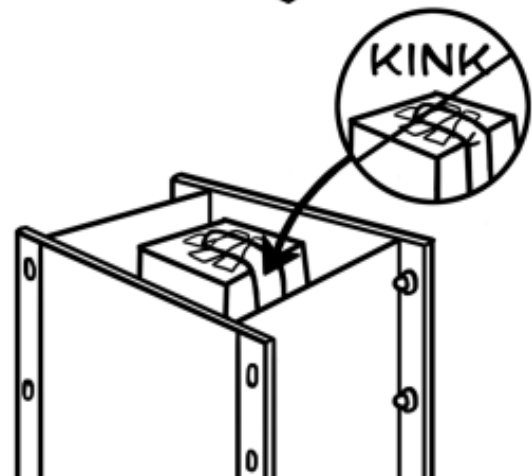
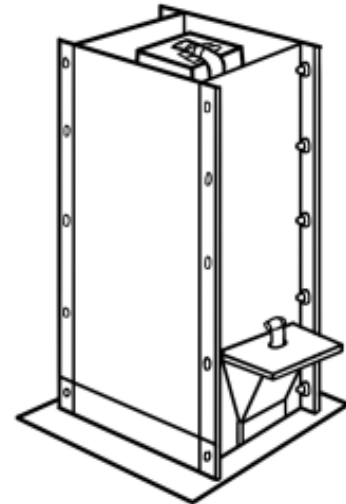

## Stage E: Make the Concrete Container

### 2. Pour the filter

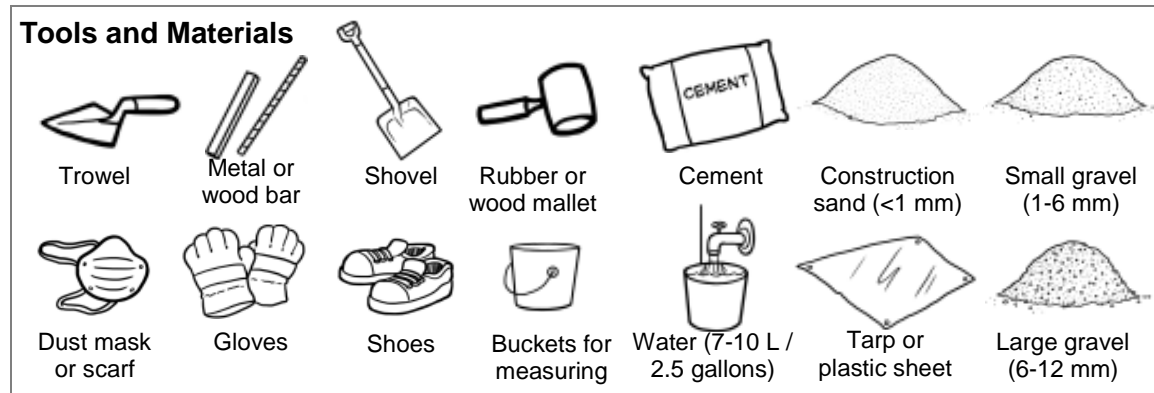

#### A Note about Cement

Be specific about the type of cement you use. You do NOT want to use pre-mixed cement with sand and gravel. Depending on the country, the following are different names of cement which are all the same product: Portland Cement, White Ordinary Portland Cement, General Use Cement, General Use Hydraulic Cement, Type 1 Cement, Type 10 Cement.

The cement should be fresh and not exposed to moisture. If there are lumps in the cement, it has probably been wet and should not be used. You can NOT break up the lumps and reuse the cement.



1. Measure the cement, sand and gravel into a pile using a bucket. You need to know how much each bucket holds. Do not use a shovel to measure, because you do not know how much material is on the shovel each time.



#### For 1 filter, you will need:

- 12 L of Cement
- 12 L of 6-12mm Gravel
- 12 L of 1-6mm Gravel
- 24 L of <1mm Sand



- Use equal amounts of cement, small gravel and large gravel
- 12 L is about equal to 11 dry quarts
- Use twice as much sand

The following concrete mix ratio has been tested and proven to work:

**1 part cement : 1 part 6-12 mm gravel : 1 part 1-6 mm gravel : 2 parts sand**

For any batch size, the most important thing is to keep the proportions of the ingredients the same. You can double or triple the batch size simply by doubling or tripling the number of containers of each ingredient you add to the mix.

## Stage E: Make the Concrete Container

### 2. Pour the filter –Continued



- Mix the dry materials very well.



- Add the 7-10L of water slowly while mixing. Mix it well.

 The concrete should look quite dry.

- Test the concrete: Stick a shovel into the pile several times to make ridges.



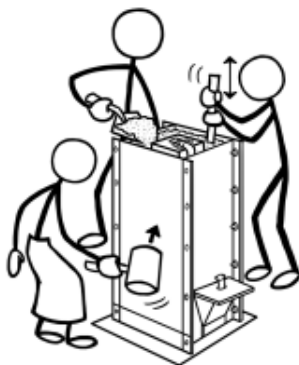

- If the ridges are easy to see, it is good to use.
- If there are no ridges and the concrete just crumbles, it is too dry. Add more water.
- If the ridges disappear, it is too wet. Add more cement, sand, small gravel, and large gravel. Remember to add twice as much sand as gravel.

- Fill the mold slowly with concrete. Use a long, thin piece of wood or a piece of metal rebar to push the concrete down.



Hit the mold many times with the rubber or wood mallet. Start hitting at the bottom of the mold and then move upwards to the top of the mold. This gets air bubbles out. Keep hitting the mold from the bottom to the top as you add more concrete.

 Be careful NOT to hit the outlet tube inside the mold when using the wood or metal rebar!

 Hit the nose many times to make sure it fills with concrete before the level of the concrete goes above the nose. Water should come out around the nose plate.

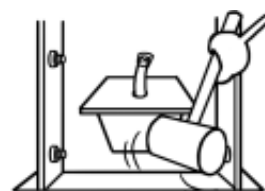

## Stage E: Make the Concrete Container

### 2. Pour the filter –Continued

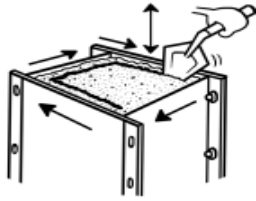

6. When the mold is full, stick a trowel into the concrete all around the top edges of the mold. This will help stop leaks forming around the base of the filter.



7. Add a shovel full of concrete on top, so that the concrete is heaped up in a small hill on top of the mold.



Wait 30-45 minutes (less time if the air temperature is high).



8. Go back to the mold after 30-45 minutes. Stick a trowel into the concrete again, all around the edges of the mold. This will ensure a good bond between the concrete in the walls and the base of the filter and prevent leaks.



9. Make the top of the concrete flat. This will be the bottom of the filter, so it should be flat and level. You may also bevel (angle) the outside edges of the bottom of the filter – this will make the filter easier to move, and cause less damage to the corners when moving and installing the filter.



10. Cover the top of the mold with a wet cloth or a pile of damp sand. Put a plastic sheet or tarp over the mold. This will prevent the concrete from drying out too quickly while it is setting.











The slower concrete dries, the stronger it is in the end.

Let the filter set (rest) for up to 24 hours. It may need less time if the air temperature is high (use local experience). Do not move it while it is setting.

## Stage E: Make the Concrete Container

### 3. Remove the filter from the mold

**Tools and Materials**

|   |   |   |  |   |
|---|---|---|--|---|
|  |  |  |  |  |
| Wrench (15 mm or $\frac{9}{16}$ " )   | Rubber or wood mallet   | 4 Wood blocks   | Washing brush  | Soap  |
|  |  |  |  |   |
| Wrench (, about 38 mm or $1\frac{1}{2}$ " )                                       | Tire or bag of grain or rice  | Shoes   |  |   |



1. After the filter has set (rested) for up to 24 hours, remove the nose plate. Remove the tape covering the end of the outlet tube.
2. Turn the mold over. Use a tire or sack of grain to help you turn it over. Ensure that the filter is in a spot where it can stay for 7 days to cure. When it has just been removed from the mold, it is too fragile to move.

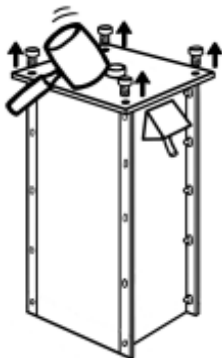

3. Remove the bolts on the TOP of the mold. (Do not loosen the bolts on the sides yet.)  
Hit the top of the mold with a mallet to loosen it from the concrete.

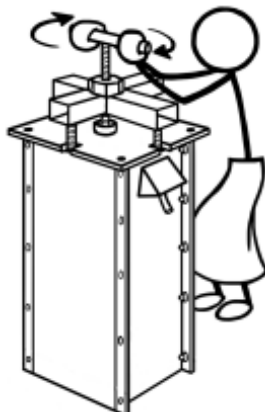

4. Put the extractor on top of the mold.  
Tighten the centre bolt (turn it clockwise) until it goes far into the nut on the mold.

## Stage E: Make the Concrete Container

### 3. Remove the filter from the mold –Continued

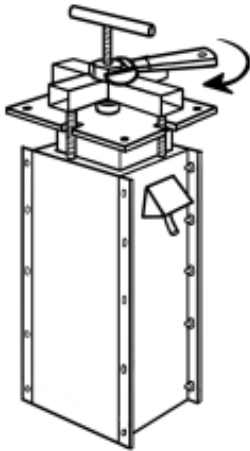

5. Attach a wrench to the nut on top of the extractor. Tighten the nut (turn it clockwise). Turn the nut until the inside mold lifts up.



If the mold gets stuck or starts to bend,  
**STOP!**

Check that all the top bolts have been removed.  
Hit the mold with a mallet. If the inside mold is still stuck, remove the outside mold.  
Break the concrete off the inside mold.

Do not damage or break the mold for 1 filter!

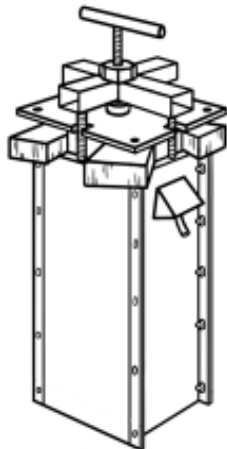

6. Put pieces of wood between the inside mold and outside mold to hold up the inside mold.
7. Remove the extractor.

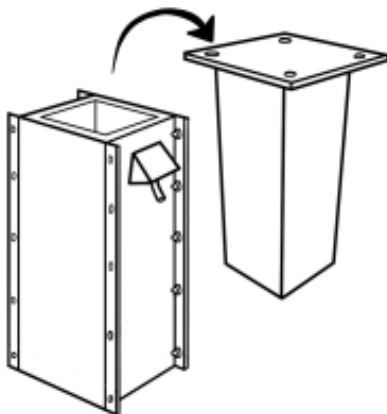

8. Lift out the inside mold. Be careful not to break the walls of the concrete filter—they are still very weak.
9. Reach inside to the bottom of the filter and remove the tape covering the outlet tube. If you can not see the tape, it may be stuck to the top of the inside mold.

## Stage E: Make the Concrete Container

### 3. Remove the filter from the mold –Continued

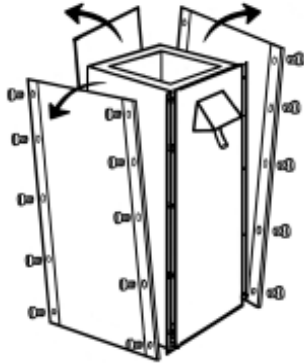

10. Remove all the side bolts as you remove the side panels of the mold. (Note: on some molds, two or three of the side panels may be welded together.)



If the mold is stuck or starts to bend, STOP!

Check that all the side bolts have been removed. Hit the mold with a mallet. If the mold is still stuck, remove the other pieces of the mold and then smash the concrete off the stuck piece of mold.

Do not damage the mold for 1 filter!

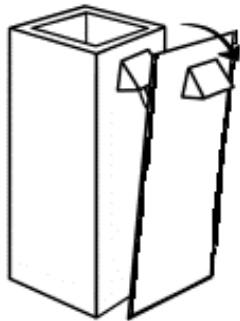

11. Remove the front (nose) panel of the steel mold.



If the front panel will not come off, try hitting it gently with a rubber or wood mallet. Or try using small metal crow-bars to pry it off.



12. Scrub any concrete off the mold. If the mold will be in storage for a while, oil it so it does not rust. Do not oil the top of the inside mold.

Put the mold away in a safe, dry place.

13. Check both ends of the outlet tube. Make sure the tube is not blocked with concrete.



Be careful not to break the walls of the filter. Do not move the filter for 7 days. The concrete is still very weak!

## Stage E: Make the Concrete Container

### 4. Finish the concrete container



1. Write a filter number on the filter. Start a Filter Production monitoring form for the filter (Appendix 1).

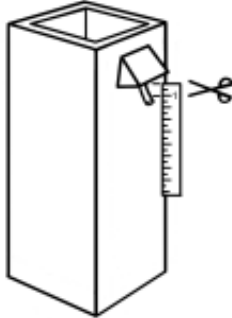

2. Check the outlet tube. It should be about 1.5 to 2 cm ( $\frac{9}{16}$ " to  $\frac{13}{16}$ " ) long. If it is too long, cut it shorter.



The water level in the filter is determined by the the end of the outlet tube. Due to a siphoning effect, the water will stop flowing when the standing water is at the same level as the end of the outlet tube. If the tube is too long, the standing water may be too shallow or even down inside the sand.



3. Fill the filter with water. Measure the flow rate—it should be about **1 litre per minute** (about 13.5 fluid oz US per minute).

Fill out the monitoring form for filter production (Appendix 1).

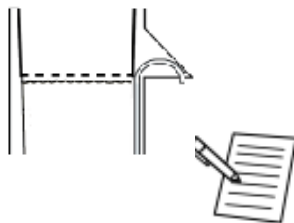

4. Once the water stops flowing, look at the water level inside the filter. Make sure it is below where the diffuser will be. If not, try to see if there is something blocking the outlet tube.

Fill out the monitoring form for Filter Production (Appendix 1).

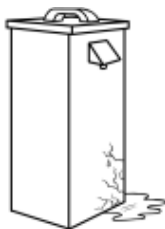

5. Check the filter for cracks and leaks.

If there are leaks, chip out the crack with a hammer and chisel. Make a paste with cement and water. Put the paste on the crack inside and outside the filter. Make it smooth. Be very careful not to break the walls of the filter as the concrete is still weak.

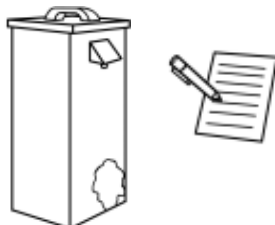

Fill out the monitoring form for Filter Production (Appendix 1).

Wait for the paste to dry before moving to the next steps.



## Stage E: Make the Concrete Container

### 4. Finish the concrete container –Continued

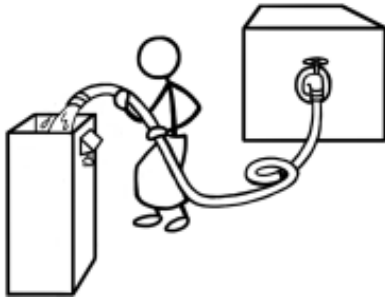

6. Plug the outlet tube with tape, cloth or a stick.

Fill the filter to the top with water. Cover the filter with a cloth, tarp or plastic sheet.



7. **Leave the filter to cure for 7 days.** Keep it full of water. Do not move the filter for 7 days. The concrete will get stronger the longer it cures.



Letting the filter **cure** means to let it rest. As it cures, the concrete will become stronger. If you try to move it before 7 days, the concrete may break.



8. After the filter has cured for 7 days, wash it out with soap. Rinse the inside of the filter with clean water until the filter is clean and there is no soap left.

Store the clean filter with other clean filters.

Fill out the monitoring form for Filter Production (Appendix 1).



9. Make the filter look nice. Filters can be painted or tiled. (See next page.)

Store the finished filters in an area with other filters that are ready to be transported to homes for installation.



Paint a filter number somewhere on the filter so you can keep records of the filters in each home.



Fill out the monitoring form for Filter Production (Appendix 1).

## Stage E: Make the Concrete Container

### 5. Make the filter look nice

The filters will go in people's homes. You can make them look nice by painting them. You can also make them look nice in other ways. You can put tiles on them or do something else that is traditional in your area.

If you paint the filters, use 1 coat of primer and 1 coat of water-based paint.



Only paint the outside of the filter.

Paint on the inside of the filter could make the water unsafe to drink.

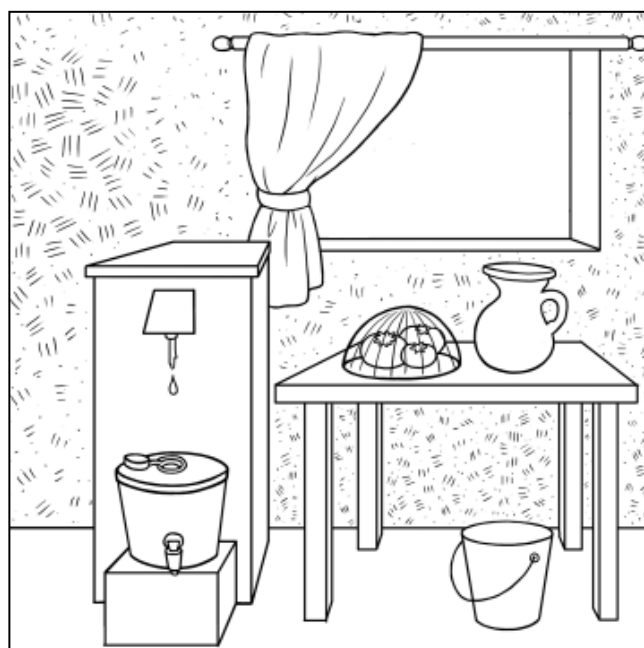
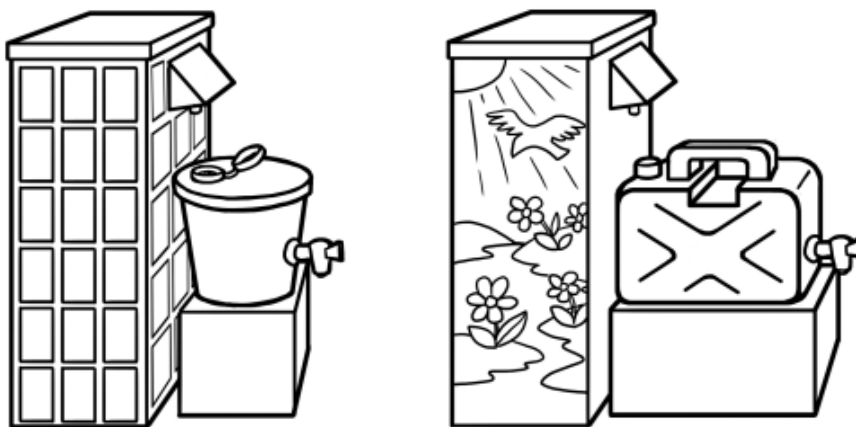

## Stage F: Make the Diffuser

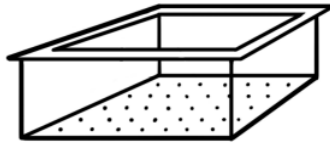

## Stage F: Make the Diffuser

The purpose of the diffuser is to protect the top of the sand from moving around when you pour the water into the filter. This protects the biolayer. The diffuser also makes sure the water drips onto the sand evenly across the top of the sand. This way all of the sand can be used to treat the water.

You can build a diffuser out of many materials. Use a material that you can find locally and that someone local has the skills to work with.

### Example Materials:

- Sheet metal (galvanized)
- Plastic
- Concrete
- Acrylic sheet

Diffuser boxes work better than diffuser plates. Diffuser boxes have to be made out of galvanized sheet metal. CAWST recommends making diffuser boxes.

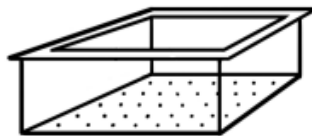

Sheet metal diffuser box

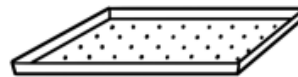

Sheet metal diffuser plate

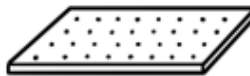

Acrylic sheet diffuser plate

### Design:

- Holes should be 3 mm ( $\frac{1}{8}$ " ) in diameter. You can use a 3 mm ( $\frac{1}{8}$ " ) nail to make the holes. Larger holes will cause disturbance of the surface of the sand. Smaller holes will restrict the flow through the filter, possibly causing the flow rate to drop
- Holes should be spaced out by 2.5 cm (1" ) in a grid pattern.
- The diffuser should fit tightly inside the filter, and there should not be any gaps between the diffuser and the concrete walls. A gap allows water to travel along the walls of the filter, rather than being distributed evenly through the holes of the diffuser plate. A tight fit also keeps the diffuser from floating.
- The diffuser should be easy to remove.

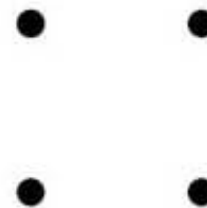

Hole size (3mm) and spacing (1")  
(actual size)



Be careful working with sharp edges, especially when using sheet metal. Use gloves.

### Stage G: Make the Lid

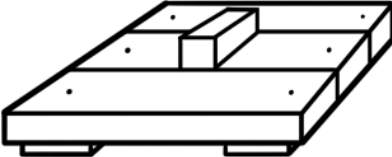

## Stage G: Make the Lid

The purpose of the lid is to stop anything from getting inside the filter.

You can build a lid out of many materials. Use a material that you can find locally and that someone local has the skills to work with.

### Example Materials:

- Sheet metal (galvanized)
- Simple wood
- Carved wood
- Ceramic tiles
- Concrete

Lids will be on the filters all the time, inside people's homes. They should look nice.

### Design:

- The lid should cover the entire top of the filter.
- It should not be easily knocked off the filter.
- It should be easy to take off and put on again.
- Some lids have handles, some do not. If there is no handle, people can store items on top of the filter lid.
- On wooden lids, the handle should be attached to the lid with at least 2 nails going into the lid at different directions, so that the handle does not pull out when you lift the lid.
- Wood lids should be painted with an oil-based paint to stop mould from growing inside the lid.



Sheet metal lid



Concrete lid with metal handle

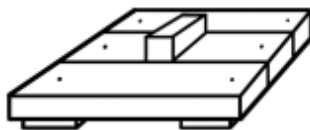

Wood lid with handle



Carved wood lid

### Stage H: Install the Filter



## Stage H: Install the Filter

---

These are the steps to install a filter:

1. Put the filter in a good location.
2. Put in the drainage gravel, separation gravel and sand.
3. Check the flow rate.
4. Flush the filter.
5. Fill out the monitoring form for Filter Installation (Appendix 1).

Before you leave the home, you must teach the users how to use the filter. (See Stage I: Educate the User).

Try to install a few filters nearby each other on the same day. While you are waiting for the water to run through one filter, you can start installing the next filter.



Before you install the filter, make sure the outlet tube is not blocked. When you fill the empty filter to the top with water, the flow rate should be about **1 litre per minute**. When it stops flowing, the top of the water should be just below the diffuser.

This should have been checked when the container was made. But it is good to check it again now - before you fill the filter with gravel and sand!

Also make sure the inside of the filter is clean. Check that the filter is level.

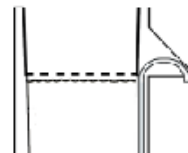
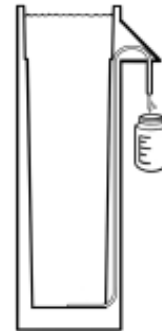

The next page has a list of things you need to take with you when you go to install filters.



## Stage H: Install the Filter

### 1. Things to take with you for an installation

You will need to take all of these things with you when you go to install a filter:



#### Putting in the sand and gravel

- Filter
- Safe storage container (if provided with the filter)
- Sand (30 L or 27 quarts)
- Separation gravel (3 1/4 L or 3 quarts)
- Drainage gravel (3 L or 2.7 quarts)
- Diffuser
- Lid



- Extra sand and gravel
- Extra diffuser in case one gets broken or does not fit
- Extra lid in case one gets broken or does not fit



- Measuring tape or ruler
- Level to check if the filter is level and flat
- Wooden bar for measuring how deep the gravel is during installation
- Shovel or trowel for putting sand and gravel in the filter
- Small buckets for measuring sand and gravel if they are not in the correct size bags already
- Buckets for pouring and catching water
- Small bucket or cup for removing dirty water from the top of the filter (Swirl and Dump)



#### Checking the flow rate

- Stopwatch, timer or watch
- Bottle or measuring container



#### Educating the users and filling out monitoring form

- Pen or pencil
- Monitoring forms
- Education materials and your organization's contact details to leave with the family

## Stage H: Install the Filter

---

### 2. Transport the filter and supplies for installation

You will need a way to transport the filters to people's homes for installation. You will also need to transport the sand, gravel and other supplies you need to install the filter. If you transport many filters in one vehicle, use sand bags, sacks or other materials to cushion the filters well.

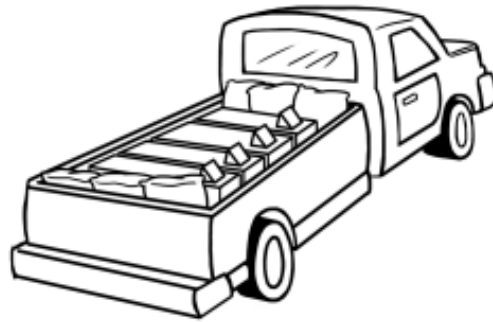

Truck or van

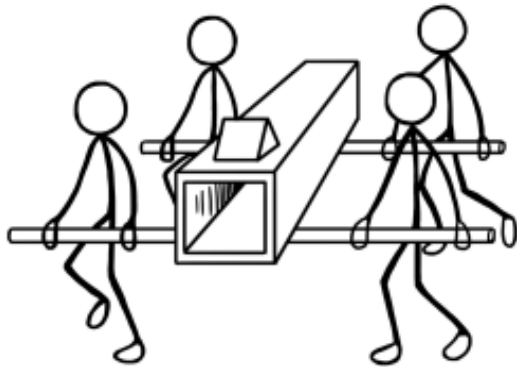

Moving the filter on bars

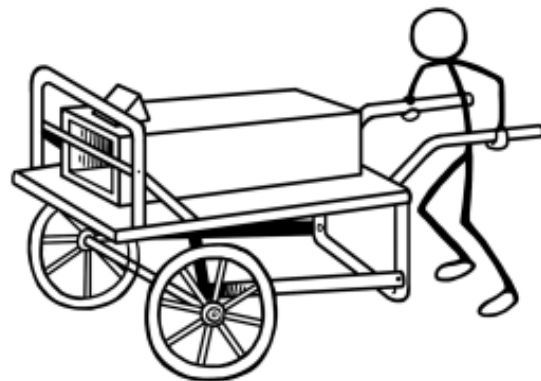

Hand cart



Cart pulled by an animal

## Stage H: Install the Filter

### 3. Position

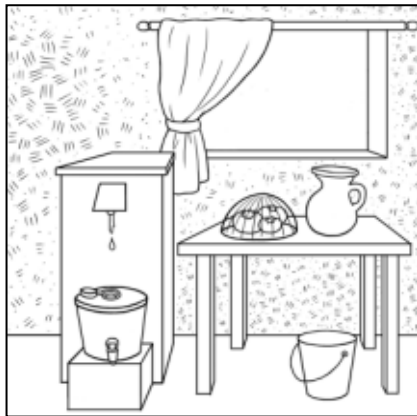

The filter should be in a safe place. It should also be easy for the family to use.

The filter should be:

- Away from sunlight, rain, animals and children
  - On flat, level ground or floor
  - In or near the kitchen, where it will be easy to use and clean
  - Where there is room to lift buckets and pour them into the filter
- If users are short, it is difficult to pour a bucket of water into the filter. They can use a step in front of the filter to make it easier.
  - It is best to put filters inside the house. They can also be put under a roof on the side of the house.
  - Filters full of sand and gravel should never be moved. They are too heavy, and moving the filter may cause it to stop working.



**Once the filter is filled with sand and gravel, it cannot be moved!**

If the user wants the filter moved later, a technician needs to come and take out all the sand and gravel. Then they can move the filter. Then the technician must reinstall the filter with sand and gravel as if it was a new filter.





If the filter is moved without first taking out the sand and gravel, it may not work as well after it is moved. Sand or gravel may block the outlet tube.

### 4. Put in the sand and gravel

| Tools and Materials   |        |                            |  |  |  |  |
|-----------------------|--------|----------------------------|--|--|--|--|
|                       |        |                            |  |  |  |  |
| Tape measure or ruler | Level  | Wood bar or leveling stick | About 3 1/4 litres or 3 quarts of washed separation gravel | About 3 litres or 2.7 quarts of washed drainage gravel | About 30 litres or 27 quarts of washed filtration sand |  |
|                       |        |                            |  |  |  |  |
| Water                 | Bucket | Shoes                      |  |  |  |  |

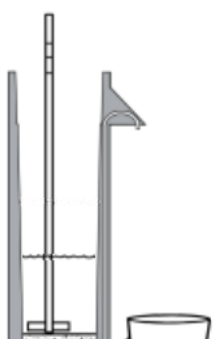
## Stage H: Install the Filter

### 4. Put in the sand and gravel –Continued

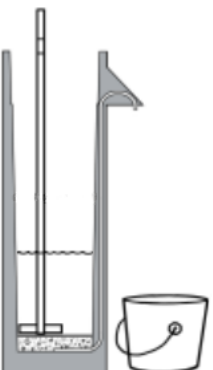
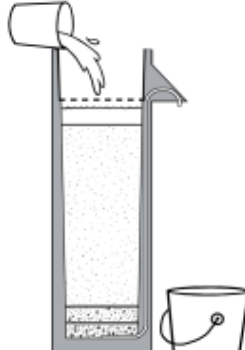
|  |   |
|--|---|
|  <p>1. Put a stick into the filter and touch the bottom of the filter. Draw a line on the stick even with the top of the filter.</p> <p>Put a bucket under the filter outlet to catch any water that flows out during the installation.</p>   |  <p>6. Put separation gravel into the filter until it is 5 cm (2") deep. This should be about 3 1/4 litres of gravel. Make the top of the gravel flat and level using the stick.</p> <p>Put the stick on top of the gravel. If the third (bottom) line on the stick is level with the top of the filter, you have added enough gravel (5 cm).</p> |
|  <p>2. Draw another line on the stick 5 cm (2") down from the first line.</p> <p>Draw a third line 5 cm (2") down from the second line.</p>  | <p>7. Quickly add about 30 L of filtration sand, until the sand comes up to the line you drew on the inside of the filter. As you add the sand, the water level in the filter should always be higher than the sand. You may have a little dry sand at the very top – this is ok. See the note on the following page.</p>   |
|  <p>3. Draw a line on the inside of the filter, about 24 to 26 cm down from the top. This is about where the sand should come to.</p> <p>Put about 10 litres of water in the filter. Having water in the filter when you put in the gravel and sand will prevent air pockets and dry spots in the sand.</p>                         |    |
|  <p>4. Put drainage gravel into the filter until it is 5 cm (2") deep. This should be about 3 litres of gravel. Make the top of the gravel flat and level using the stick.</p> <p>Put the stick on top of the gravel. If the second line on the stick is level with the top of the filter, you have added enough gravel (5 cm).</p> |  <p>8. Put in the diffuser. Pour a bucket of water into the top of the filter. Let the filter run until the water stops flowing. This could take an hour or more. Use this time to educate the user, or install another filter in a nearby location.</p>  |

## Stage H: Install the Filter

### 4. Put in the sand and gravel –Continued



Ideally, and with practice, you should be able to use the right amounts of water and sand so that once you have added all the sand, the water level is exactly at the top of the sand and there is no dry sand on top. The amounts of water and sand you need to get this will vary from mold to mold, depending on each mold's exact size.

\*Note: after you pour a bucket of water into the filter, the water level will be at its normal level: 4-6 cm above the top of the sand.

Where you draw the line on the inside of the filter to show where the top of the sand should be will also depend on the size of the mold. It should be roughly 4-6 cm below where the normal standing water level will be, or 4-6 cm below the level of the end of the outlet tube.

*This installation procedure has been updated to improve results and conserve water. Previously, CAWST advised filling the filter half full of water during installation. This updated method, using only 9 to 11 litres of water:*

- Reduces foaming and dirtying of the water in the filter
- Wastes less water (no water will flow out of the outlet tube during installation)
- Reduces settling of large particles and suspension of fine particles during installation, resulting in better mixing of sand grains inside the filter, and
- Requires less flushing of the filter to achieve clear, filtered water following the installation.

10. When the water stops flowing, check the depth of the water above the sand. The water should be between 4 and 6 cm deep (1.5 to 2.5”).

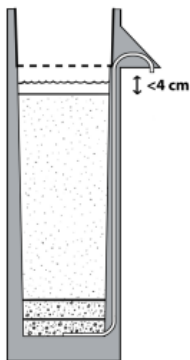

**If the standing water level is less than 4 cm (1.5”) deep**, check the outlet tube. If it is longer than 2 cm ( $\frac{13}{16}$ ”), cut it shorter. Fill the filter with water again and measure the standing water level again.

If the water is still less than 4 cm deep, there is too much sand. Take some sand out. Make the top of the sand smooth and flat. Put the diffuser in. Pour a bucket of water into the top of the filter and let it run until the water stops flowing. Measure the standing water level again.

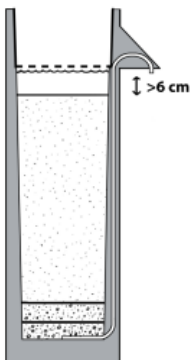

**If the standing water level is more than 6 cm (2.5”) deep**, there is not enough sand. Add some more sand. Make the top of the sand smooth and flat. Put the diffuser in. Pour a bucket of water into the top of the filter and let it run until the water stops flowing. This could take an hour or more. After the water stops flowing, measure the standing water level again.

## Stage H: Install the Filter

### 4. Put in the sand and gravel –Continued



11. When the water above the sand is between 4 and 6 cm deep, you have added enough sand. Now you need to clean the top of the sand so the filter does not clog.

Put your hand flat on the top of the sand, and swirl it around the surface of the sand. The water above the sand will become very dirty.



12. Remove the dirty water using a cup or small bucket. Throw this water away - dump it down a drain or into the bushes.

Repeat the Swirl and Dump in steps 11 and 12 until the water in the top of the filter stays clear. If you remove all the water, put the diffuser back in before pouring more water into the top of the filter. Then you can repeat the Swirl and Dump.



13. Fill out the monitoring form for Filter Installation (Appendix 1).

### After you install the filter, it should have these layers:

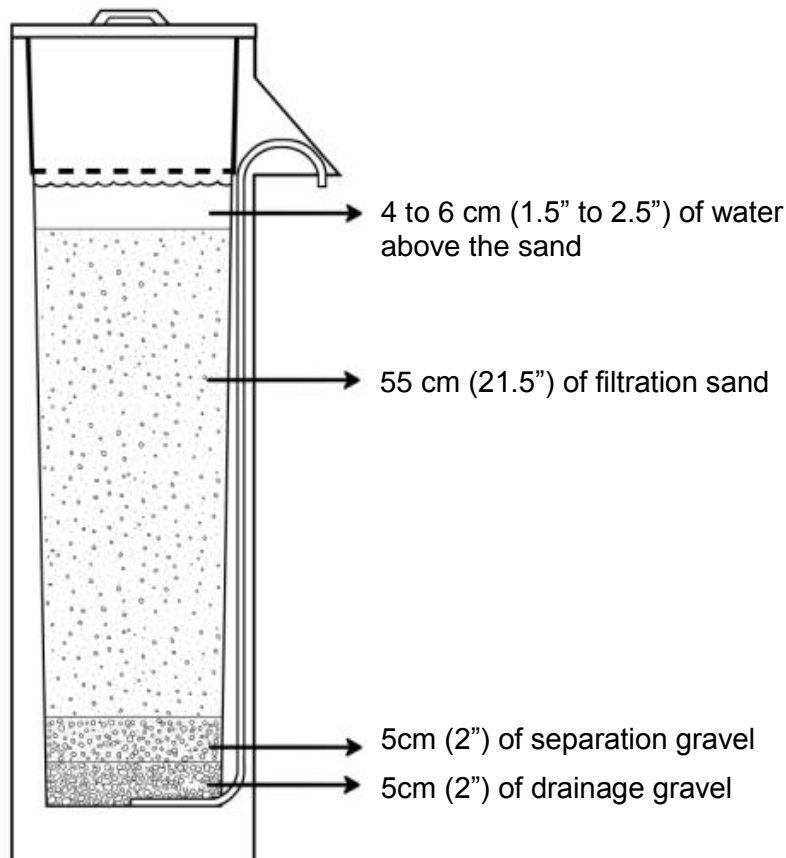

## Stage H: Install the Filter

### 5. Check the flow rate

#### Tools and Materials



Water  
(12 litres or  
3 gallons)



Bucket to collect  
filtered water



Measuring container or old bottle  
to measure collected water



Stopwatch or  
timer

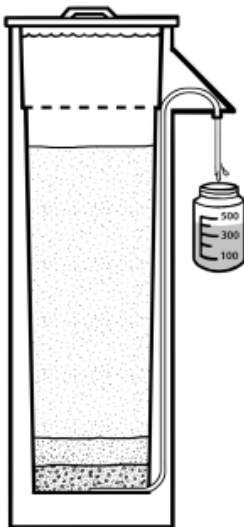

1. Fill the filter to the top with water.
2. Start the timer. Hold the measuring cup or bottle under the outlet to collect the water. Measure the flow rate.



Measure the flow rate when the filter is full.  
The flow rate will get slower as it empties.

#### Using a measuring container



If you are using a measuring container, collect water for exactly 1 minute. Then look to see how much water you collected.

**You should get 400 mL or less in 1 minute.**

If you get less than 300 mL in 1 minute, the sand was not washed enough.

If you get more than 450 mL per minute, the sand was washed too much. You need to reinstall the filter with different sand.

*\*Note: The flow rate should be 400 mL or less per minute if you are using Version 10 filters. If you are using older molds (Version 8 or 9), the flow rate should be 600 mL or less per minute.*

## Stage H: Install the Filter

### 5. Check the flow rate –Continued

#### Using a 1 L bottle



If you are using a 1L bottle, time how long it takes to fill the bottle.

**It should take 2 minutes and 30 seconds or longer to fill a 1 L bottle.**

If it takes more than 3 minutes and 20 seconds to fill the bottle, the sand was not washed enough.

If it takes less than 2 minutes and 10 seconds, the sand was washed too much. You need to reinstall the filter with different

#### Using a 500 mL bottle



If you are using a 500 mL bottle, time how long it takes to fill the bottle.

**It should take 1 minute 15 seconds or longer to fill a 500 mL bottle.**

If it takes more than 1 minute and 40 seconds to fill the bottle, the sand was not washed enough.

If it takes less than 1 minute and 5 seconds, the sand was washed too much. You need to reinstall the filter with different

You can use this table to convert between mL per minute and the time it takes to fill a 1 L bottle, a 500 mL bottle or a 20 fluid ounce bottle.

| mL per minute | Time to fill 1L         | Time to fill 500 mL     | Time to fill 20 oz      |
|---------------|-------------------------|-------------------------|-------------------------|
| 300           | 3 min 20 seconds        | 1 min 40 seconds        | 2 minutes               |
| 350           | 2 min 50 seconds        | 1 min 25 seconds        | 1 min 40 seconds        |
| <b>400</b>    | <b>2 min 30 seconds</b> | <b>1 min 15 seconds</b> | <b>1 min 30 seconds</b> |
| 450           | 2 min 10 seconds        | 1 min 5 seconds         | 1 min 20 seconds        |
| 500           | 2 minutes               | 1 minute                | 1 min 10 seconds        |
| 550           | 1 min 50 seconds        | 55 seconds              | 1 min 5 seconds         |
| 600           | 1 min 40 seconds        | 50 seconds              | 1 minute                |



4. Fill out the monitoring form for Filter Installation (Appendix 1).



## Stage H: Install the Filter

### 5. Check the flow rate –Continued

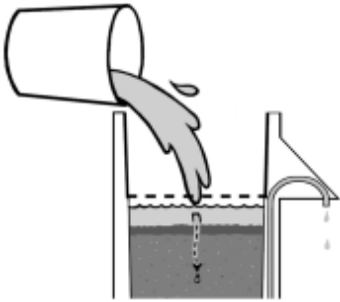

**WHAT IF THE FLOW RATE IS TOO SLOW?**

If the flow rate is less than 400 mL/minute, the filter will still work.

But users may not like a slow flow rate. The flow rate will get even slower as they use the filter because the top of the sand clogs with dirt. If the flow rate gets too slow, they may stop using the filter.

If the flow rate is too slow after you install the filter, you can try to make it faster by cleaning the top of the sand. Do a Swirl and Dump. Swirl the top of the sand with your hand. Then use a cup to dump out the dirty water in the top of the filter.

If the flow rate is not faster after doing 4 “Swirl and Dumps”, you must wash all the sand more. Take all the sand out of the filter. Take the sand back to be washed again. Do another jar test. Install 1 filter and test the flow rate. Tell the people who wash the sand that it has not been washed enough, so they can adjust their washing method.

Reinstall the filter in the home with new gravel and sand that has been washed more. Check the flow rate again.

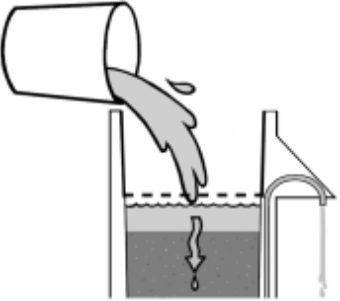

**WHAT IF THE FLOW RATE IS TOO FAST?**

If the flow rate is more than 400 mL/minute, the filter might not work as well. It might not remove as many pathogens from the water.

If the flow rate is higher than 450 mL/minute, you should replace the sand. Take all the sand out of the filter. Start with new sand and wash it less. Do a jar test. Install 1 filter and test the flow rate. Tell the people who wash the sand, so they know they are washing it too much.

Reinstall the filter with the new sand and gravel. Check the flow rate again.

## Stage H: Install the Filter

### 6. Flush the filter

#### Tools and Materials



Water  
(40 to 80 litres or  
10 to 20 gallons)



Bucket to collect  
water from outlet

Flushing the filter will remove any dirt and fine sediment that may still be in the sand and gravel. Sometimes there is fine sediment that comes out the outlet tube as a result of the installation procedure. If these fine particles are not flushed out of the filter now, the user may see them in the water when they start pouring water through the filter, and they may stop using the filter.

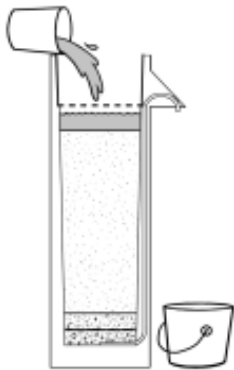

1. Make sure the diffuser is in the filter. Put a bucket under the outlet to catch water.

Pour a bucket of clear water into the top of the filter. Use the clearest water possible.

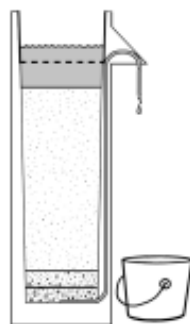

2. Look at the water coming out of the outlet tube. It may be dirty at first. It will get clearer as more water flows through the filter.

Using the updated installation procedure above will reduce the amount of flushing needed.

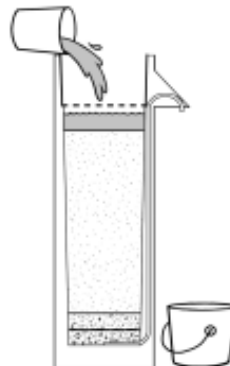

3. When the filter stops flowing, throw the dirty water in the collection bucket away—pour it down a drain or into the bushes.

Pour another bucket of water into the top of the filter.

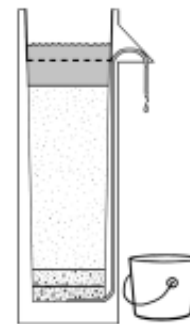

4. Continue pouring water into the filter until the water coming out of the spout is clear.

In some cases, it may take up to 40 to 80 litres (10 to 20 gallons) before the filtered water is clear.

5. Check the standing water level. The water above the sand should be 4 to 6 cm (1.5" to 2.5") deep. The surface of the water should be below the diffuser, not touching it.

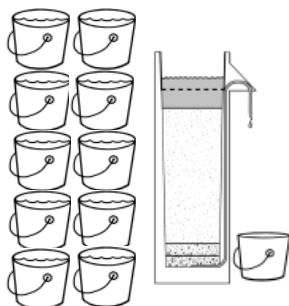

#### WHAT IF THE WATER NEVER GETS CLEAR?

If you have put more than 10 buckets of water (124 litres or 30 gallons) into the top of the filter and the water coming out of the spout still is not clear, the gravel was not washed enough. You must take the sand and gravel out of the filter. Wash the gravel more, until it is completely clean and there is no dirt in the water in the wash bucket. Then reinstall the filter, using the clean gravel.

## Stage I: Educate the User



## Stage I: Educate the User

### 1. Educating the users

It is very important that the users know how to use the filter. At the same time the filter is installed, someone must teach them how to use it, and how and when to clean it.

There is a lot of information for users to remember. Repeat visits will be necessary to follow-up with the users – to answer their questions, remind them of information they have forgotten, teach new information, and demonstrate or affirm how they should use and clean the filter.

See the next section on follow-up visits for tips on how to conduct household visits.

### 2. How to use the filter

It is very important that the users know how to use the filter. At the same time the filter is installed, someone must teach them how to use it and how and when to clean it.

#### Using your biosand filter

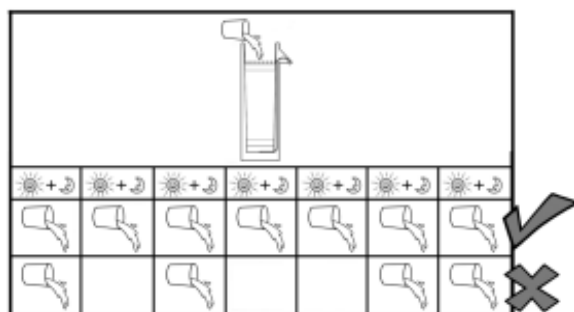

#### 1. Use the filter every day.

After the filter has stopped flowing, wait at least 1 hour before pouring another bucket of water in. The filter needs time to treat the water. This is the Pause Period.

Do not go more than 2 days without pouring water into the filter. If you go away for 2 or more days, ask someone else to pour water into your filter every day. The filter needs a fresh dose of oxygen and nutrients. If you go too long without adding water, the standing water may evaporate, causing the biolayer to dry out and die.

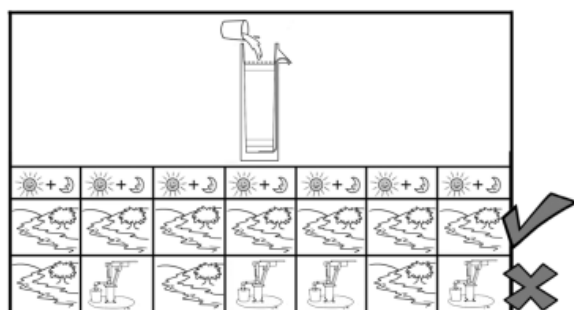

#### 2. Always pour water from the same source into the filter. If you change sources, the filter will not work as well for a few days. If you use different water sources in different seasons, it is important to disinfect the filtered water for a few days after you change sources.

## Stage I: Educate the User

### 2. How to use the filter –Continued

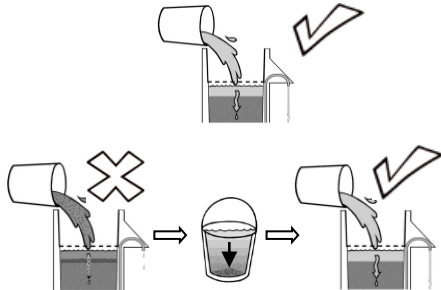

3. **Use the cleanest, clearest water possible in the filter.**

If you only have dirty, cloudy water, let it sit in a container until the dirt has settled to the bottom. Then pour the clear water into the filter.

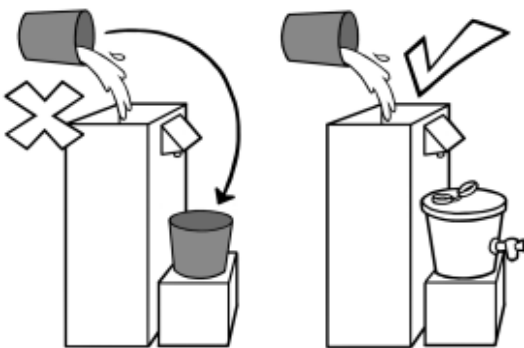

4. **Use one container to collect water to pour into the filter, and use a different container to collect the filtered water.** If you use the same container, you will make the filtered water dirty again.



**Use a safe storage container to catch the filtered water.**



8. **Disinfect the filtered water.** You can disinfect it by adding chlorine drops or chlorine tablets, using SODIS, or boiling the filtered water.

The biosand filter removes most of the dirt and pathogens. But for the best, safest water, you should also disinfect it.

Disinfecting the filtered water is especially important:

- during the first month of using the filter (while the biolayer is still growing),
- whenever you change water sources, and
- in the few days after doing a Swirl and Dump cleaning.

During these times, the biolayer is not working at its peak level. As such, the filter may not be treating water to its best capacity. Disinfecting the water at these times will make sure all the pathogens are removed.

## Stage I: Educate the User

### 2. How to use the filter –Continued

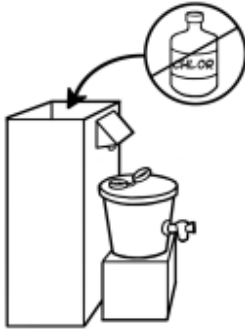

7. **Never put chlorine into the top of the filter.** Chlorine will kill the biolayer. Without the biolayer, the filter will not work as well.



5. **Always make sure the diffuser is in the filter when you pour water in.** Never pour water directly onto the sand. This may damage the biolayer.

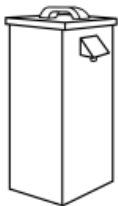

6. **Always keep the lid on the filter.** This will keep insects, contaminants and other objects out. It will also keep hands and food from being contaminated by the dirty water and the diffuser in the top of the filter.



9. **Keep the outlet tube open. Do not put a hose or tap on the filter outlet tube.** Due to the siphoning effect in the outlet tube, putting a hose on the filter will drain the filter of all its water and may kill the biolayer. Putting a tap on the outlet tube will cause the standing water level to remain too high, which may kill the biolayer.
10. **Use the filter only for water. Do not store food in the top of the filter.** Some people store food inside the filter because it is cool. But the inside of the filter is not clean — it collects dirt and pathogens! It will make food dirty and unsafe to eat. Food may also attract insects and animals to the filter.

## Stage I: Educate the User

### 3. How to clean the filter

The users must know how to clean the filter. There are 2 ways they must clean the filter.

1. Wash the diffuser, lid, and the outside of the outlet tube.
2. Whenever the flow rate gets too slow, they should do a Swirl and Dump to make the flow rate faster again.

#### Cleaning the parts of the filter

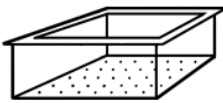

The diffuser collects dirt and large particles that are in the water. It may get very dirty. The dirt will not harm the drinking water, since the water is filtered after it touches the diffuser. But it is a good idea to clean the diffuser. Cleaning the dirt off the diffuser will help keep the dirt from clogging the sand. It will help keep the flow rate from getting too slow.



It is also good to wash the lid. If the family stores anything on top of the lid, it should be clean. Also, it will look nicer if it is clean.



- Once a week, wash the diffuser and lid in soapy water. Then rinse them in clear water.
- You do not have to use safe, filtered water to wash the diffuser and lid. But the water should be as clean and clear as possible.
- If you don't want to put the lid into the water, you can wipe it with a clean, wet cloth.



It is important to keep the outlet tube clean. Sometimes the outside of the tube can get dirty. This may make the drinking water dirty again. This is one reason the water should be disinfected after being filtered.

- Once a week, wipe the outside of the outlet tube. Use a cloth with chlorine. Let the tube air-dry.
- If you do not have chlorine or bleach, use a wet soapy cloth. Then use a clean, wet cloth to rinse off the soap. Use filtered water to clean the outlet tube.



The user should **NEVER** put chlorine inside the outlet tube or into the top of the filter!

## Stage I: Educate the User

### 3. How to clean the filter –Continued

#### Swirl and Dump

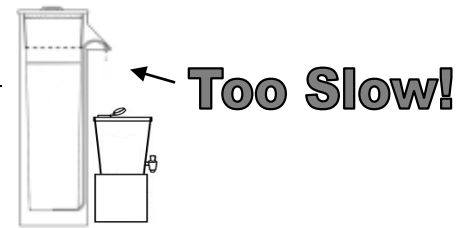

|  |   |  |  |
|--|---|--|--|
|  | <p>1. Take off the lid. Pour water into the filter until the water level is above the diffuser.</p> <p>Take out the diffuser.</p> |  | <p>5. Make the top of the sand flat and level.</p>   |
|  | <p>2. Put your hand flat on the sand. Swirl the surface of the sand around in a circle a few times.</p>                           |  | <p>6. Wash the lid and diffuser in soapy water. Rinse with clear water.</p>  |
|  | <p>3. Use a cup or small bucket to scoop out the dirty water from the top of the filter.</p>                                      |  | <p>7. Put the diffuser back in the filter.</p>   |
|  | <p>4. Pour the dirty water down a drain or into the bushes.</p> <p>Repeat steps 2, 3 and 4 a few times.</p>                       |  | <p>8. Wash your hands with soap and water. This is important since the top of the sand is very dirty.</p>  |
|  |   |  | <p>9. Pour a bucket of water into the top of the filter.</p> <p>If the flow rate is still too slow, repeat the Swirl and Dump until the flow rate is faster.</p> |



## Stage I: Educate the User

### 4. Safe water storage

Safe storage means keeping the water from getting contaminated again. If hands, dippers, cups or anything else touch the water, it will become unsafe to drink again. Open buckets are not safe storage since anything can fall into the bucket and contaminate the water.









There are many designs for safe water containers around the world. A safe water storage container should have the following qualities:

- Strong and tightly fitting lid or cover
- Tap or narrow opening for pouring water out
- Stable base so it doesn't tip over
- Easy to clean
- Durable and strong
- Containers that are not transparent (not see-through) or that have a coloured tint are better than clear bottles. Algae may grow inside clear containers since the sunlight can go through them.

## Stage I: Educate the User

### 5. How to clean a safe storage container

|   |   |  |   |
|---|---|--|---|
|    | <p>1. Wash your hands with soap.</p>  |    | <p>6. Let the container and lid air-dry.</p>  |
|    | <p>2. Wash the inside and outside of the container and its lid with soap and treated water. It can be boiled, filtered, SODIS or chlorinated water.</p> |    | <p>7. Wipe the tap with a clean cloth and chlorine.</p>   |
|   | <p>3. Empty the soapy water through the container's tap.</p>  |  | <p>8. Put chlorine tablets or drops into the container. Fill the container with treated water. Let it sit for 30 minutes.</p> |
|  | <p>4. Rinse the container and lid using treated water. It can be boiled, filtered, SODIS or chlorinated water.</p>                                      |  | <p>9. Empty the chlorinated water through the tap. You can drink this water, or dump it down a drain.</p>                     |
|  | <p>5. Empty the rinse water through the container's tap.</p>  |  |   |

## Stage I: Educate the User

### 6. Using your treated water

It is important to protect your treated water and keep it from getting dirty again.

1. **It is best if the safe storage container has a tap. If there is no tap, pour the water out.** You should be able to get the water out of the safe storage container without using a cup or dipper.



Cups and dippers can be dirty from sitting on the counter or table, or from people touching them with their hands. Dirt and pathogens from hands, a cup or dipper will go into the water. Then the water may make you sick when you drink it.

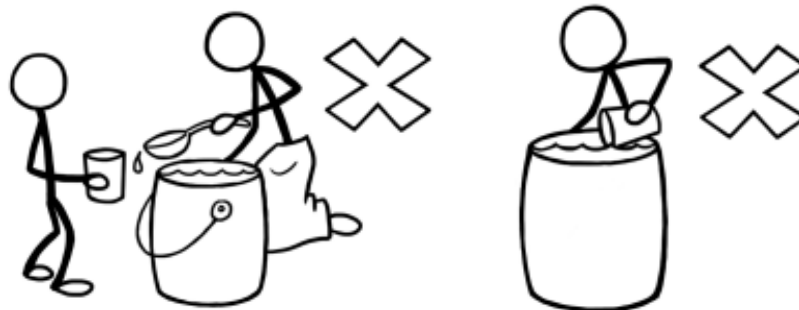

2. **Use the treated water as soon as possible.** Try to use it all within 1 day. This reduces the chance of recontamination.

The first water poured through the filter in the morning will be the best quality. Save this water for drinking. Use the water that you pour through the filter later in the day for other uses, like cooking and washing.



3. **Disinfect the filtered water.** You can disinfect it by using chlorine, SODIS, or boiling. Disinfection will kill any pathogens left in the water after filtration. Adding chlorine to your filtered water will also protect it against being contaminated again - the chlorine will kill any new pathogens that get into the water while it is being stored.





### Stage F: Follow-Up With the User



## Stage J: Follow-Up With the User

---

### 1. Follow-up visits

It is important to visit the users after they start using the filter. People forget the details about how to use and clean the filter, so you will need to remind them. They may also have questions about the filter or about water, sanitation or hygiene.



#### **When to do visits:**

- 1 week after installation
- 1 month after installation
- 3 to 6 months after installation
- 1 year after installation (optional)

### 2. How to do a household visit

- Be polite and friendly.
- Take your monitoring forms and make notes during the visit.
- Try to talk to the person or people who use the filter the most.
- Ask the user how they like the filter.
- Ask if they have any questions about using the filter or about the filtered water.



## Stage J: Follow-Up With the User

### 3. Things to check during a follow-up visit

When you visit a user, there are many things to check. Use a monitoring form for follow-up visits, like the form in Appendix 1. Ask the user questions such as the examples listed below. Record the answers on the form.

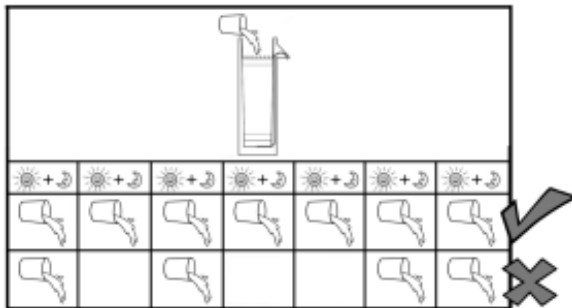

1. “How often do you pour water into the filter?”

Users should:

- Pour water into the filter at least once every day
- After the filter stops running, wait at least 1 hour before pouring in more water

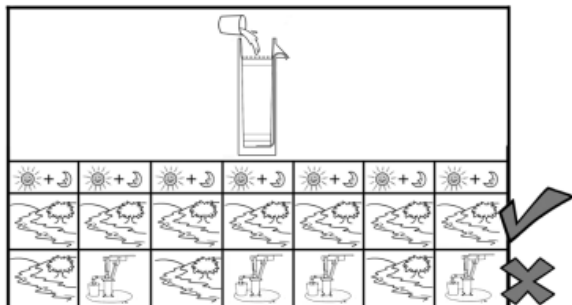

2. “Where do you get the water to pour into the filter?”

Users should:

- Use the same source of water every day

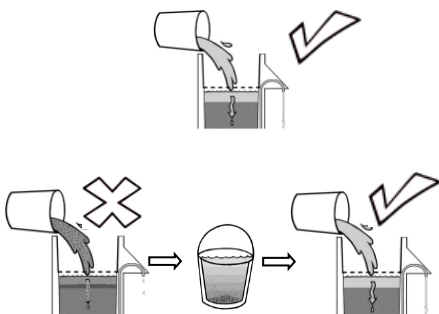

3. “Can you show me the water you pour into the filter?”

Users should:

- Pour clear water into the filter.
- If the water is too dirty, let it sit in a bucket until the dirt settles to the bottom. Then pour the clear water into the filter.

The water poured into the filter should not be too dirty - less than 50 NTU. For a quick test: fill a 2 L bottle with the water normally poured into the filter. Put the full bottle on top of the CAWST logo on a manual or monitoring form. Look down through the bottle.

**If you can see the logo**, the water is ok to pour into the filter.

**If you cannot see the logo**, the water is too dirty to pour into the filter.



## Stage J: Follow-Up With the User

### 3. Things to check during a follow-up visit –Continued

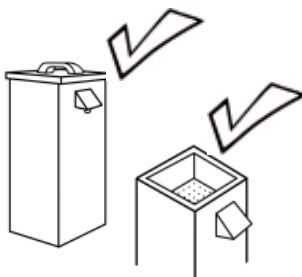

4. “May I take a look in your filter?”
- The lid should be on the filter
  - The diffuser should be inside the filter
  - The diffuser and lid should be in good condition



5. “Are there any cracks or leaks in the filter?”
- Any leaks should be repaired by you or your team
  - If you must take out the sand and gravel to fix the leak, you will need to reinstall the filter with new sand and gravel
  - If the leak cannot be repaired, you may consider replacing the leaking filter with a new filter

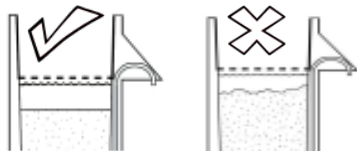

6. “May I take out the diffuser to see the sand?”
- The surface of the sand should be flat and level
  - If there are small holes or dents in the sand, look at the diffuser to see if it has cracks or if it does not fit tightly in the top of the filter
  - If there are big holes and valleys in the sand, ask the user if they sometimes pour water into the filter without the diffuser. Remind them to always keep the diffuser in the filter.

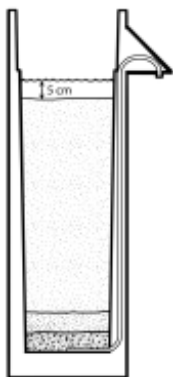

7. “May I check the depth of the water?”
- Check the depth of the water. The standing water above the sand should be about 5 cm (2”) deep. The standing water level is ok if it is between 4 cm and 6 cm (1.5” to 2.5”).

**Tip:** If you do not have a ruler, put your hand into the water. The water should come up to the 2nd knuckle on your middle finger. This is about 5 cm!  
**Wash your hands after** – the water in the top of the filter is full of pathogens!

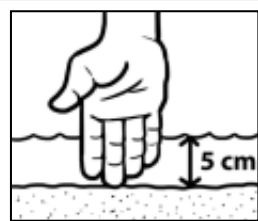



## Stage J: Follow-Up With the User

### 3. Things to check during a follow-up visit –Continued

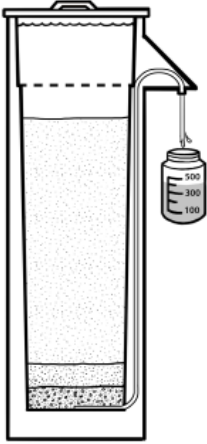

8. “Can we fill the filter to check the flow rate?”
- The flow rate should be **400 mL per minute or less**
  - If you are filling a 1 L bottle, it should take 2 minutes 30 seconds or longer to fill
  - If you are filling a 500 mL bottle, it should take 1 minute 15 seconds or longer to fill
  - If you are filling a 20 oz (US) bottle, it should take 1 minute 30 seconds or longer to fill

If the flow rate is very slow, ask the user:

- “Was the flow rate faster when the filter was first installed, or has it always been this slow?”
- “Have you ever done a Swirl and Dump?”
- Ask them to show you how to do a Swirl and Dump. Show them again if they do not remember. Explain that this will help the flow rate become faster again.



9. “Do you clean the filter? How do you clean it?”

Users should:

- Wash the diffuser and lid in soapy water, and keep the outside of the filter clean
- Wipe the outlet tube with a clean cloth and chlorine



10. “Has the flow rate ever become too slow? What did you do?” (only ask this if you did not ask them before.)

Users should:

- Do a Swirl and Dump on the top of the sand

“Can you show me how to do a Swirl and Dump?”

- Add water, take out the diffuser and swirl their hand around, flat on the sand. Then scoop and dump out the dirty water in the top of the filter.

See Stage I: Educate the User, Part 2 above, or the CAWST picture-poster for instructions on how to do a Swirl and Dump. You can leave a poster with the users to remind them.

## Stage J: Follow-Up With the User

### 3. Things to check during a follow-up visit –Continued



11. “What containers do you use to collect water from the source? Can you show me? Can you also show me what containers you store your filtered water in?”

Users should:

- Use one container to pour dirty water into the filter, and a different container to collect the filtered water at the outlet
- Use a safe storage container to catch the filtered water
- Store drinking water covered with a lid to keep dirt and insects out



12. “Do you do anything to the filtered water before you drink it?”

Users should:

- Disinfect the filtered water, such as by using chlorine, boiling or SODIS

If the users add chlorine, ask them where they put the chlorine.

Users should:

- Put chlorine in the safe water storage container, never in the top of the filter



13. “Do you clean your water container? How do you clean it?”

Users should:

- Wash the inside of the safe storage container with soap and treated water
- If chlorine is available, they should add chlorine to the water and let it sit for 30 minutes
- Wipe the tap with a clean cloth and chlorine

See Stage I: Educate the User, Part 4 above or the CAWST picture poster for instructions on how to clean a safe water container. You can leave a poster with the users to remind them.



Fill out the monitoring form for Filter Follow-up Visits (Appendix 1).

## Self-Review (Part 2)

---

1. What are the five steps of the multi-barrier approach? Give an example for each.

| Step | Example |
|------|---------|
| 1.   |         |
| 2.   |         |
| 3.   |         |
| 4.   |         |
| 5.   |         |

2. Label the parts of a biosand filter.

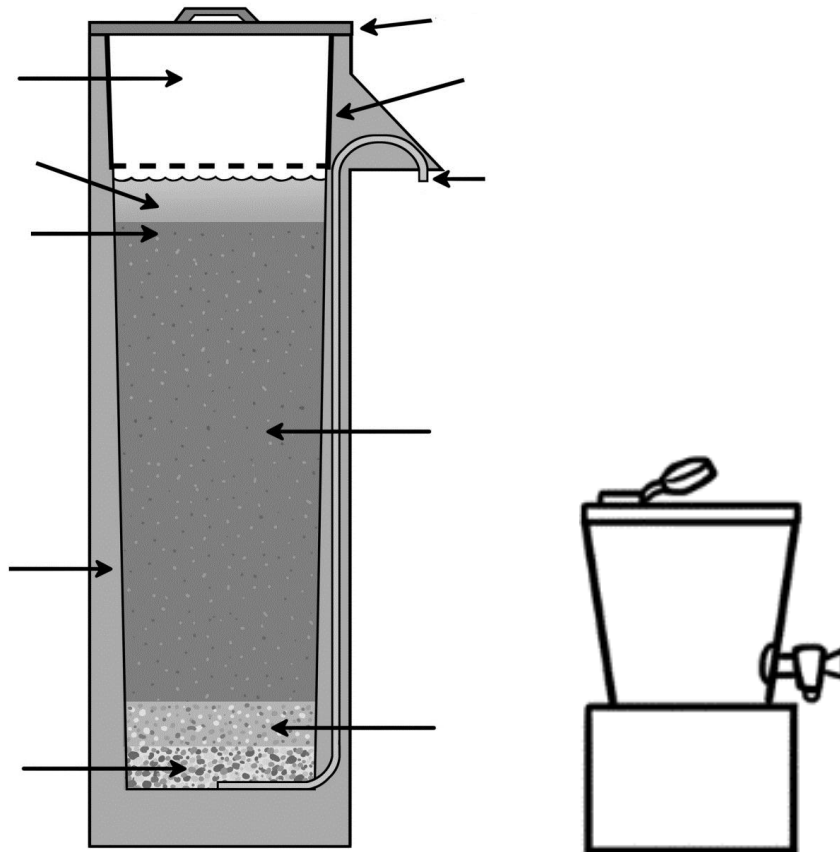

3. For each part of the biosand filter describe the function.

| Part Name | Function |
|-----------|----------|
| 1.        |          |
| 2.        |          |
| 3.        |          |
| 4.        |          |
| 5.        |          |
| 6.        |          |
| 7.        |          |
| 8.        |          |
| 9.        |          |
| 10.       |          |
| 11.       |          |

4. What should the flow rate be for a biosand filter?

5. List the 3 best sources of filtration sand, in order of how good they are for using inside the biosand filter. List the best source of sand first.

|    |
|----|
| 1. |
| 2. |
| 3. |

6. Draw and describe what you will use to sieve filtration sand and gravel. Explain how you will sieve the sand and gravel.

7. Draw a proper safe storage container. For each part of the container, explain how it helps keep water safe.

8. List the 8 Key Filter Performance Points (the important points to check to see if the biosand filter is working properly).

|    |
|----|
| 1. |
| 2. |
| 3. |
| 4. |
| 5. |
| 6. |
| 7. |
| 8. |

9. Describe the 2 ways users need to clean the filter. Explain when users should clean the filter each way.

| Type of cleaning | When to do it |
|------------------|---------------|
| 1.               |               |
| 2.               |               |

10. Explain why it is important to have the filter container half full of water when you put in the gravel and sand during installation.

11. Explain why users should never put chlorine into the top of the filter.

12. Describe when you need to fill out monitoring forms and where to find examples of the forms.





## Additional Resources

---

CAWST manuals and education resources are available to download from our website:

<http://www.cawst.org/en/resources/pubs>

- Introduction to Household Water Treatment and Safe Storage
- Household Water Treatment technology fact sheets
- Community Health Promotion
- Introduction to Low Cost Sanitation
- Project Planning
- WASH activities and posters
- BSF research summaries and technical updates

Google Groups discussion forum for the Biosand Filter:

BSF production (construction) group

<https://groups.google.com/forum/#!forum/bsf-production>

BSF implementation group

<https://groups.google.com/forum/?fromgroups#!forum/bsf-best-practices>

Videos about the biosand filter on YouTube (CAWST videos Playlist):

<http://www.youtube.com/playlist?list=PL21D2F07AA53BA64F>

or

<http://www.youtube.com/user/cawstvideos>

\* CAWST is not responsible for the content of the videos in the above playlist(s).

Safe Storage:

WEDC Booklet 4. An engineer's guide to domestic water containers.

<http://wedc.lboro.ac.uk/knowledge/booklets.html>

## References

---

Aiken, B.A., C.E. Stauber, G.M. Ortiz, M.D. Sobsey. (2011). An Assessment of Continued Use and Health Impact of the Concrete Biosand Filter in Bonao, Dominican Republic. *Am. J. Trop. Med. Hyg.*, 85(2), 2011, pp 309-317.

Buzunis, B. (1995). Intermittently Operated Slow Sand Filtration: A New Water Treatment Process. Department of Civil Engineering, University of Calgary, Canada.

Baumgartner, J. (2006). The Effect of User Behavior on the Performance of Two Household Water Filtration Systems. Masters of Science thesis. Department of Population and International Health, Harvard School of Public Health. Boston, Massachusetts, USA.

Duke, W. and D. Baker (2005). The Use and Performance of the Biosand Filter in the Artibonite Valley of Haiti: A Field Study of 107 Households, University of Victoria, Canada.

Earwaker, P. (2006). Evaluation of Household BioSand Filters in Ethiopia. Master of Science thesis in Water Management (Community Water Supply). Institute of Water and Environment, Cranfield University, Silsoe, United Kingdom.

Elliott, M., Stauber, C., Koksai, F., DiGiano, F., and M. Sobsey (2008). Reductions of *E. coli*, echovirus type 12 and bacteriophages in an intermittently operated 2 household-scale slow sand filter. *Water Research*, Volume 42, Issues 10-11, May 2008, Pages 2662-2670.

Jenkins, M.W., S.K. Tiwari, J. Darby. (2011). Bacterial, viral and turbidity removal by intermittent slow sand filtration for household use in developing countries: experimental investigation and modeling. *Water Research* 45 (2011), pp 6227-6239.

Murphy, H.M., E.A. McBean, K. Farahbakhsh. (2010). A critical evaluation of two point-of-use water treatment technologies: can they provide water that meets WHO drinking water guidelines? *Journal of Water and Health*, 08.4, 2010, pp 611-630.

Ngai, T., Murcott, S. and R. Shrestha (2004). Kanchan Arsenic Filter (KAF) – Research and Implementation of an Appropriate Drinking Water Solution for Rural Nepal.

Palmateer, G., Manz, D., Jurkovic, A., McInnis, R., Unger, S., Kwan, K. K. and B. Dudka (1997). Toxicant and Parasite Challenge of Manz Intermittent Slow Sand Filter. *Environmental Toxicology*, vol. 14, pp. 217- 225.

Stauber, C. (2007). The Microbiological and Health Impact of the Biosand Filter in the Dominican Republic: A Randomized Controlled Trial in Bonao. PhD Dissertation, Department of Environmental Sciences and Engineering, University of North Carolina, Chapel Hill, USA.

Stauber, C., Elliot, M., Koksai, F., Ortiz, G., Liang, K., DiGiano, F., and M. Sobsey (2006). Characterization of the Biosand Filter for Microbial Reductions Under Controlled Laboratory and Field Use Conditions. *Water Science and Technology*, Vol 54 No 3 pp 1-7.

Stauber, C.E., E.R. Printy, F.A. McCarty, K.R. Liang, M.D. Sobsey. (2011). Cluster Randomized Controlled Trial of the Plastic Biosand Water Filter in Cambodia. *Environ. Sci. Technol.* 2012 Jan 17; 46(2):722-8 (EPub 2011 Dec 20).

Sobsey, M. (2007). UNC Health Impact Study in Cambodia. Presentation, Cambodia.

World Health Organization (WHO). (2011). Guidelines for Drinking-water Quality, Fourth Edition. Available online at: [http://www.who.int/water\\_sanitation\\_health/publications/2011/dwg\\_guidelines/en/index.html](http://www.who.int/water_sanitation_health/publications/2011/dwg_guidelines/en/index.html)

## Appendix 1 - Monitoring Forms (Examples)

|   |       |
|---|-------|
| Filter Construction Monitoring Forms .....                | A1-1  |
| BSF Production Monitoring Form.....                       | A1-3  |
| Sand and Gravel Preparation Monitoring Form.....          | A1-5  |
| Trial Installation Flow Rate Results.....                 | A1-7  |
| Diffuser and Lid Monitoring Form.....                     | A1-9  |
| Filter Installation Monitoring Forms .....                | A1-11 |
| Biosand Filter Installation Monitoring Form.....          | A1-13 |
| Biosand Filter Multi-Installation Monitoring Form .....   | A1-15 |
| Follow-Up Monitoring Forms .....                          | A1-17 |
| Biosand Filter Follow-Up Visit Monitoring Form .....      | A1-19 |
| Biosand Filter Multi Follow-Up Visit Monitoring Form..... | A1-21 |
| Follow-Up Visit Monitoring Form (Visual).....             | A1-23 |



# Filter Construction Monitoring Forms



|                                      |
|--------------------------------------|
| ✓ if acceptable<br>✗ if unacceptable |
|--------------------------------------|

### BSF Production Monitoring Form

Location: \_\_\_\_\_ Date: \_\_\_\_\_

| Mold Number | Date Poured<br>day/<br>month | Filter Number | No Leaks<br>After<br>Demolding<br>✓ or ✗ | 7 Days of<br>Curing<br>Time<br>✓ or ✗ | Filter<br>Container<br>Washed<br>Out<br>✓ or ✗ | Empty<br>Flow Rate<br>✓ or ✗ | Flow Rate<br>(mL/<br>minute) | Water Level<br>Below<br>Diffuser<br>✓ or ✗ | Filter<br>Ready for<br>Installation<br>✓ or ✗ | Comments<br>Or Recommended<br>Actions |
|-------------|------------------------------|---------------|--|---------------------------------------|--|------------------------------|------------------------------|--|---|---------------------------------------|
|             |                              |               |  |                                       |  |                              |                              |  |   |                                       |
|             |                              |               |  |                                       |  |                              |                              |  |   |                                       |
|             |                              |               |  |                                       |  |                              |                              |  |   |                                       |
|             |                              |               |  |                                       |  |                              |                              |  |   |                                       |
|             |                              |               |  |                                       |  |                              |                              |  |   |                                       |
|             |                              |               |  |                                       |  |                              |                              |  |   |                                       |
|             |                              |               |  |                                       |  |                              |                              |  |   |                                       |
|             |                              |               |  |                                       |  |                              |                              |  |   |                                       |
|             |                              |               |  |                                       |  |                              |                              |  |   |                                       |
|             |                              |               |  |                                       |  |                              |                              |  |   |                                       |
|             |                              |               |  |                                       |  |                              |                              |  |   |                                       |
|             |                              |               |  |                                       |  |                              |                              |  |   |                                       |
|             |                              |               |  |                                       |  |                              |                              |  |   |                                       |
|             |                              |               |  |                                       |  |                              |                              |  |   |                                       |
|             |                              |               |  |                                       |  |                              |                              |  |   |                                       |
|             |                              |               |  |                                       |  |                              |                              |  |   |                                       |
|             |                              |               |  |                                       |  |                              |                              |  |   |                                       |
|             |                              |               |  |                                       |  |                              |                              |  |   |                                       |
|             |                              |               |  |                                       |  |                              |                              |  |   |                                       |
|             |                              |               |  |                                       |  |                              |                              |  |   |                                       |
|             |                              |               |  |                                       |  |                              |                              |  |   |                                       |
| TOTAL ✗     |                              |               |  |                                       |  |                              |                              |  |   |                                       |
| TOTAL ✓     |                              |               |  |                                       |  |                              |                              |  |   |                                       |

Technician Signature: \_\_\_\_\_ Supervisor Signature: \_\_\_\_\_ Date: \_\_\_\_\_

**Tips and Guidelines for Use**

|                            | <b>Mold Number</b>   | <b>Date Poured (day/month)</b>   | <b>Filter Number</b>  | <b>No Leaks After Demolding</b><br>✓ or ✗   | <b>7 Days of Curing Time</b><br>✓ or ✗  | <b>Filter Container Washed Out</b><br>✓ or ✗                           |
|----------------------------|--|--|---|---|---|--|
| <b>Tips and Guidelines</b> | This is needed to track if there are problems with the filter containers built with this mold. | This can help identify if there were problems with the concrete that was mixed that day. | This is to help track individual filters. If problems are identified later, all aspects of the filter's production can be reviewed. | If there were no leaks, then the processes and capacity of technicians are acceptable. If leaks were identified some analysis can be done to help determine why and help make improvements. | If curing time is tracked, it helps to ensure that the necessary 7 days of curing is respected. | This can help to track if the production processes are being followed. |

|                            | <b>Empty Flow Rate</b><br>✓ or ✗   | <b>Flow Rate (mL/minute)</b>  | <b>Water Level Below Diffuser</b><br>✓ or ✗        | <b>Filter Ready for Installation</b><br>✓ or ✗             | <b>Comments Or Recommended Actions</b> |
|----------------------------|--|---|--|--|--|
| <b>Tips and Guidelines</b> | The filter container should be filled to the top with water. Water should flow freely from the outlet tube, meaning the tube is not blocked. | Recording empty filter flow rate confirms that the tube is not blocked or kinked before installation. | Confirms that the outlet tube is the right length. | Tracks if filters are ready to be delivered and installed. |  |



### Sand and Gravel Preparation Monitoring Form

Form #: \_\_\_\_\_ Location: \_\_\_\_\_ Dates: \_\_\_\_\_

**Use ✓ = acceptable or ✗ = unacceptable**

| Sieve Sizes       | Sieve Set in Good Condition | Sand/Gravel Sieved Properly | Sieved Sand/Gravel Organics Free (Visual Inspection) | Gravel Washed Clean | Jar Test Result on Filtration Sand | Sand /Gravel Stored Properly | The Sand is Useable | The Gravel is Useable | Additional Comments |
|-------------------|-----------------------------|-----------------------------|--|---------------------|------------------------------------|------------------------------|---------------------|-----------------------|---------------------|
| 12 mm (1/2")      |                             |                             |  |                     |                                    |                              |                     |                       |                     |
| 6 mm (1/4")       |                             |                             |  |                     |                                    |                              |                     |                       |                     |
| 1 mm (0.04")      |                             |                             |  |                     |                                    |                              |                     |                       |                     |
| 0.7 mm (0.03")    |                             |                             |  |                     |                                    |                              |                     |                       |                     |
| <b>TOTAL</b><br>✗ |                             |                             |  |                     |                                    |                              |                     |                       |                     |
| <b>TOTAL</b><br>✓ |                             |                             |  |                     |                                    |                              |                     |                       |                     |

Lead Technician: \_\_\_\_\_ Manager Signature: \_\_\_\_\_ Date: \_\_\_\_\_

**Tips and Guidelines for Use**

| <b>Sieve Set in Good Condition</b>   | <b>Sand/Gravel Sieved Properly</b>  | <b>Sieved Sand/Gravel Organics Free (Visual Inspection)</b>  | <b>Gravel Washed Clean</b>  |
|--|---|--|---|
| This is to ensure that the sieve sets are not damaged which would affect the quality of sieving. | This refers to organization of the sand preparation area, to stop different sizes of sand and gravel from mixing. Also refers to whether the sieved sand and gravel are correctly separated into the different sizes (<0.7mm, 0,7-6mm, <1mm, 1-6mm and 6-12mm). | To confirm that the prepared sand and gravel does not have organic material (e.g. grass or leaves) in it. This is difficult when the sand preparation area is outside. | To confirm the gravel has been washed enough and is ready for installation. |

| <b>Jar Test Result on Filtration Sand</b>  | <b>Sand /Gravel Stored Properly</b>  | <b>The Sand is Useable</b>   | <b>The Gravel is Useable</b>   |
|--|--|--|--|
| Write the number of washes done on the filtration sand to get a good jar test result. This can be compared to the trial installation test results (see Trial Installation Flow Rate Results form). | Confirms the processes of bagging and storing of materials properly is being followed. | Overall, the prepared sand is good quality and ready to take for installation. | Overall, the prepared gravel is good quality and ready to take for installation. |

|   |                 |
|---|-----------------|
| ✓ | if acceptable   |
| ✗ | if unacceptable |

**Trial Installation Flow Rate Results**

| Test #         | Test Date | Sand Source | Delivery Date (Day/Month) | Number of Washes done on Filtration Sand | Jar Test Result<br>✓ or ✗ | Trial Installation Flow Rate (mL/min) | Flow Rate Result<br>✓ or ✗ |
|----------------|-----------|-------------|---------------------------|--|---------------------------|---------------------------------------|----------------------------|
| 1              |           |             |                           |  |                           |                                       |                            |
| 2              |           |             |                           |  |                           |                                       |                            |
| 3              |           |             |                           |  |                           |                                       |                            |
| 4              |           |             |                           |  |                           |                                       |                            |
| 5              |           |             |                           |  |                           |                                       |                            |
| 6              |           |             |                           |  |                           |                                       |                            |
| 7              |           |             |                           |  |                           |                                       |                            |
| 8              |           |             |                           |  |                           |                                       |                            |
| 9              |           |             |                           |  |                           |                                       |                            |
| 10             |           |             |                           |  |                           |                                       |                            |
| <b>TOTAL ✓</b> |           |             |                           |  |                           |                                       |                            |
| <b>% ✓</b>     |           |             |                           |  |                           |                                       |                            |

Technician Name: \_\_\_\_\_ Supervisor Signature: \_\_\_\_\_ Date: \_\_\_\_\_

**Guidelines and Tips for Use**

| Sand Source                        | Delivery Date (Day/Month)  | Number of Washes of Filtration Sand   | Jar Test Result<br>✓ or ✗  | Trial Installation Flow Rate (mL/min)   | Flow Rate Result<br>✓ or ✗   |
|------------------------------------|--|---|--|---|--|
| To track where the sand came from. | To know when the sand was delivered, helps to know which batch the sand came from. | Tracking to find the average number of washes required to get a good jar test result. This number can be compared to the trial installation flow rate result. | Indicate here whether or not the sand was jar tested and if it was acceptable. This is for comparison to the trial installation. If the jar test result was good, but the trial installation is not good, then some investigation needs to happen to determine why. You may have to adjust what a “good” jar test result is. | Install one filter with sand that has a good jar test result. Test the flow rate and write it here. Compare the result to the jar test result and flow rates after filters are installed in homes to check the quality and consistency of sand preparation. | Indicate here if the flow rate was acceptable. The flow rate should be 400 mL or less per minute. If the flow rate is more than 450 mL per minute, or less than 300 mL per minute, it is not acceptable. |

**Diffuser and Lid Monitoring Form**

Location: \_\_\_\_\_

Dates: \_\_\_\_\_

Use ✓ to agree or ✗ to disagree

|                                 |  |
|---------------------------------|--|
| Lids Built Properly             |  |
| Lids Fit Properly               |  |
| Diffusers Fit Properly          |  |
| Diffuser holes = 3 mm or less   |  |
| Diffuser holes = 2.5 cm Spacing |  |

Recommended actions to improve:

Lead Technician: \_\_\_\_\_

Supervisor Signature: \_\_\_\_\_

Date: \_\_\_\_\_

Location: \_\_\_\_\_

Dates: \_\_\_\_\_

Use ✓ to agree or ✗ to disagree

|                                 |  |
|---------------------------------|--|
| Lids Built Properly             |  |
| Lids Fit Properly               |  |
| Diffusers Fit Properly          |  |
| Diffuser holes = 3 mm or less   |  |
| Diffuser holes = 2.5 cm Spacing |  |

Recommended actions to improve:

Lead Technician: \_\_\_\_\_

Supervisor Signature: \_\_\_\_\_

Date: \_\_\_\_\_



## Filter Installation Monitoring Forms





**Biosand Filter Installation Monitoring Form**

|                      |                          |
|----------------------|--------------------------|
| <b>Date</b>          | <b>Location</b>          |
| <b>Your Name</b>     | <b>Name of Household</b> |
| <b>Filter Number</b> | <b>Phone Number</b>      |
| <b>Address</b>       |                          |

|   | YES<br>✓ | NO<br>✗ |
|---|----------|---------|
| <b>Quality of Construction</b>  |          |         |
| 1. There are no leaks in the filter container   |          |         |
| 2. The lid has no damage and covers the entire top of the filter  |          |         |
| 3. The diffuser has no damage and fits correctly with no gaps around the edges<br>Box <input type="checkbox"/> Plate <input type="checkbox"/> |          |         |
| <b>Proper Installation</b>  |          |         |
| 5. The filter is in a good location, away from weather and animals  |          |         |
| 4. The filter is level  |          |         |
| 6. The filter was installed by putting water in the filter container, then adding the gravel and sand   |          |         |
| 7. The surface of the sand is flat and level  |          |         |
| 8. The depth of the water above the sand is between 4 and 6 cm  |          |         |
| 9. The flow rate of the filter is less than 0.4 litres/minute (or it takes longer than 2 minutes 30 seconds to fill a 1 litre bottle)         |          |         |
| 10. The user has a container for safe water storage   |          |         |
| <b>Training Provided to User</b>  |          |         |
| 11. The users have been taught how to use and maintain the filter   |          |         |
| 12. The swirl and dump maintenance procedure has been shown to the user   |          |         |
| 13. The user was given an instructional poster/brochure/sticker   |          |         |
| 14. The user knows who to contact if they have questions  |          |         |
| <b>Collection of Payment</b>  |          |         |
| 15. Payment has been collected from the user and a receipt given  |          |         |
| <b>TOTAL YES / NO</b>   |          |         |

**Notes:**

---

ALL POINTS SHOULD BE MARKED "YES" BEFORE COMPLETING INSTALLATION

---

## Installation Monitoring Form - Reference Guide

---

### Quality of Construction

1. If the filter is leaking, tell the manufacturer so they can fix it.
2. If the lid is damaged or does not fit, use another one and tell the manufacturer.
3. If the diffuser is damaged or does not fit, use another one and tell the manufacturer.

### Proper Installation

4. The filter should be inside the house or at least under a roof. It should be kept out of the way of animals, maybe with a fence. If the filter needs to be moved once it is installed, a technician will have to re-install the sand and gravel.
5. If the filter is not level, make it level before doing anything else.
6. If gravel and sand are put into the filter when it is not full of water, it will trap air bubbles in the filter. The filter should be emptied out and re-installed if this happens.
7. It is essential that the sand surface is leveled after installation. If the sand is not flat and level, the biolayer will not grow evenly.
8. The water depth should be 5 cm above the sand. If it is more than 5 cm, add more sand. If it is less than 3 cm, remove some sand.
9. When you fill the reservoir with water, the flow rate should be less than 0.4 litres/minute. If the flow rate is faster, the filter will not work properly. The filter should be re-installed with new sand. If the flow rate is slower, the filter is working fine. If you think the flow rate is too slow and the users do not like it, ask the users if they have done a swirl and dump maintenance. If the user has not done a swirl and dump, do one with the users to show them how.
10. Each user should have a safe storage container so the filtered water does not become contaminated again. The storage container should stop people's hands, cups, or dippers from touching the water, have a lid and be easy to clean.

### Training Provided to User

11. The user should receive a full explanation of the use and maintenance of the filter and should be able to repeat it back to the installer.
12. The procedure should be demonstrated and then, if possible, practiced by the user.
13. Any printed information available should be left with the user to help them remember the important points of using and maintaining the filter.
14. The users must know how to contact someone if they have problems with their filter or want to ask a question. If not, they may just stop using the filter.

### Collection of Payment

15. A receipt should be given to the user for their payment to the filter. This prevents the loss of any money and prevents future disputes.

### Biosand Filter Multi-Installation Monitoring Form

if acceptable  
 if unacceptable

Technician Name: \_\_\_\_\_ Location: \_\_\_\_\_ Date: \_\_\_\_\_

| Date Installed | Filter Number | Household name | Location and Phone Number of Household | Location of Filter In House | Flow Rate (mL/min) | Flow Rate less than 400mL/min<br>✓ or ✗ | Standing Water Depth 4 to 6 cm<br>✓ or ✗ | Swirl and Dump Shown to User<br>✓ or ✗ | Safe Storage<br>✓ or ✗ | Comments |
|----------------|---------------|----------------|--|-----------------------------|--------------------|---|--|--|------------------------|----------|
|                |               |                |  |                             |                    |   |  |  |                        |          |
|                |               |                |  |                             |                    |   |  |  |                        |          |
|                |               |                |  |                             |                    |   |  |  |                        |          |
|                |               |                |  |                             |                    |   |  |  |                        |          |
|                |               |                |  |                             |                    |   |  |  |                        |          |
|                |               |                |  |                             |                    |   |  |  |                        |          |
|                |               |                |  |                             |                    |   |  |  |                        |          |
|                |               |                |  |                             |                    |   |  |  |                        |          |
|                |               |                |  |                             |                    |   |  |  |                        |          |
|                |               |                |  |                             |                    |   |  |  |                        |          |
|                |               |                |  |                             |                    |   |  |  |                        |          |
| TOTAL ✓        |               |                |  |                             |                    |   |  |  |                        |          |
| TOTAL ✗        |               |                |  |                             |                    |   |  |  |                        |          |

Technician Signature: \_\_\_\_\_ Supervisor Signature: \_\_\_\_\_ Date: \_\_\_\_\_



## Follow-Up Monitoring Forms



**Biosand Filter Follow-Up Visit Monitoring Form**

|                      |                          |
|----------------------|--------------------------|
| <b>Date</b>          | <b>Location</b>          |
| <b>Your Name</b>     | <b>Name of Household</b> |
| <b>Filter Number</b> | <b>Phone Number</b>      |
| <b>Address</b>       |                          |

|   | YES<br>✓ | NO<br>✗ |
|---|----------|---------|
| <b>The Filter</b>   |          |         |
| 1. There are no leaks in the filter container   |          |         |
| 2. The lid has no damage and covers the entire top of the filter  |          |         |
| 3. The diffuser has no damage and fits correctly with no gaps around the edges<br>Box <input type="checkbox"/> Plate <input type="checkbox"/> |          |         |
| 4. The filter is in a good location, away from weather and animals  |          |         |
| 5. The surface of the sand is flat and level  |          |         |
| 6. The depth of the water above the sand is between 4 and 6 cm  |          |         |
| 7. The flow rate of the filter is less than 0.4 litres/minute (or it takes longer than 2 minutes 30 seconds to fill a 1 litre bottle)         |          |         |
| 8. The water does not have a bad taste or smell   |          |         |
| <b>How the Filter is Used</b>   |          |         |
| 9. There is no tap and no hose attached to the outlet spout   |          |         |
| 10. The outlet spout is clean   |          |         |
| 11. The filter is used every day  |          |         |
| 12. The water poured into the filter is clear   |          |         |
| <b>Safe Water Storage</b>   |          |         |
| 13. The treated water storage container has a lid   |          |         |
| 14. The storage container has a narrow opening or a tap to get water out  |          |         |
| 15. The storage container is clean  |          |         |
| 16. The user has separate containers for collecting and storing water   |          |         |
| <b>Problems with the Filter</b>   |          |         |
| 17. Any other problems? (Write them down below.)  |          |         |
| <b>TOTAL YES / NO</b>   |          |         |

Notes/Problems:

---



---

---

## Follow-Up Visit Monitoring Form Reference Guide

---

### The Filter

1. If the filter is leaking, tell the manufacturer so they can fix it.
2. If the lid is missing or damaged, either the user or the manufacturer can replace it.
3. If the diffuser is damaged, replace it with a new diffuser.
4. The filter should be inside the house or at least under a roof. It should be kept out of the way of animals, maybe with a fence. If the filter needs to be moved, a technician will have to re-install the sand and gravel.
5. If the sand is not flat and level, the diffuser may not be working. If the sand looks like it has been pushed away from the concrete walls, the water may be running around the edges of diffuser plate and the diffuser may need to be replaced.
6. The water depth should be 5 cm above the sand. If it is less than 4 cm or more than 6 cm, add more sand or take some sand out. The biolayer will take 30 days to re-grow.
7. When you fill the reservoir with water, the flow rate should be less than 0.4 litres/minute. If the flow rate is faster, the filter will not work properly. The filter should be re-installed with new sand. If the flow rate is slower, the filter is working fine. If you think the flow rate is too slow and the users do not like it, ask the users if they have done a swirl and dump maintenance. If the user has not done a swirl and dump, do one with the users to show them how.
8. If the treated water has a bad taste or smell, ask the user if they changed the water source recently. Ask them if their water always has that taste or smell at this time of year. Try flushing the filter with many buckets of water. If the problem does not go away after 2-4 weeks, a technician should re-install the filter with new gravel and sand.

### How the Filter is Used

9. There cannot be any taps, valves, hoses or tubes on the outlet spout- the filter will not work well.
10. The outlet spout should not have any dirt or algae on it and should be cleaned regularly. If it is dirty recommend to the user that regular cleaning with soap or chlorine on a cloth is required.
11. The filter must be used every day or two for it to work properly. If it is not being used regularly, instruct the user on the need to use their filter every one or two days and tell the person who is responsible for training users so they can do a follow-up visit.
12. The water that the user pours into the top of the filter should not be too dirty or cloudy. To test if it is too dirty, fill a 2 litre bottle with the water. Put the bottle on top of the CAWST logo on this form. Look down into the top of the bottle. If you can see the CAWST logo through the water in the bottle, the water is OK to pour into the BSF. If you cannot see the logo through the water in the bottle, the water is too dirty to pour into the BSF. Tell the user to let the water stand in a container for a few hours so the dirt settles to the bottom, then pour the clear water into the BSF.

### Safe Water Storage



13. The storage container should have a lid so the water does not get contaminated. It also stops people from putting their hands, cups, or dippers into the water.
14. There should be an easy way to get the water out of the container without dipping.
15. The storage container should have no dirt or algae in it. If it is not clean, explain that they need to keep the container clean, and show them how (use soap and safe water).
16. The user must use different containers for collecting water and for storing water, so that they do not contaminate their treated water. If they are not using different containers, explain that they should use separate containers and tell the person who trains the users.

### Problems with the Filter

17. Writing down any problems with filters on the correct form will help make sure they are solved and help the project manager improve the project.



## Biosand Filter Multi Follow-Up Visit Monitoring Form

 if acceptable  
 if unacceptable

Technician Name: \_\_\_\_\_ Location: \_\_\_\_\_ Date: \_\_\_\_\_

| Filter number | Household name | Flow rate<br>(mL/min) | Flow rate less than 400mL/min<br>✓ or ✗ | Diffuser OK<br>✓ or ✗ | Surface of sand is flat and level<br>✓ or ✗ | Standing water depth 4 to 6 cm<br>✓ or ✗ | Water poured into filter is not too dirty<br>✓ or ✗ | Filter used every day<br>✓ or ✗ | Filter and outlet spout clean<br>✓ or ✗ | Safe water storage<br>✓ or ✗ | Comments |
|---------------|----------------|-----------------------|---|-----------------------|---|--|---|---------------------------------|---|------------------------------|----------|
|               |                |                       |   |                       |   |  |   |                                 |   |                              |          |
|               |                |                       |   |                       |   |  |   |                                 |   |                              |          |
|               |                |                       |   |                       |   |  |   |                                 |   |                              |          |
|               |                |                       |   |                       |   |  |   |                                 |   |                              |          |
|               |                |                       |   |                       |   |  |   |                                 |   |                              |          |
|               |                |                       |   |                       |   |  |   |                                 |   |                              |          |
|               |                |                       |   |                       |   |  |   |                                 |   |                              |          |
|               |                |                       |   |                       |   |  |   |                                 |   |                              |          |
|               |                |                       |   |                       |   |  |   |                                 |   |                              |          |
|               |                |                       |   |                       |   |  |   |                                 |   |                              |          |
|               |                |                       |   |                       |   |  |   |                                 |   |                              |          |
| TOTAL ✓       |                |                       |   |                       |   |  |   |                                 |   |                              |          |
| TOTAL ✗       |                |                       |   |                       |   |  |   |                                 |   |                              |          |

Technician Signature: \_\_\_\_\_ Supervisor Signature: \_\_\_\_\_ Date: \_\_\_\_\_



### Follow-Up Visit Monitoring Form (Visual)

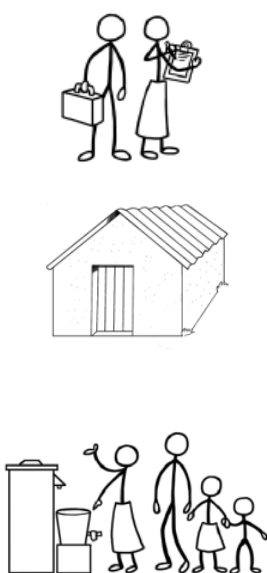

|   |  |
|---|--|
| <b>Name of Technician or Community Health Promoter:</b> |  |
| <b>Date of visit:</b>                                   |  |
| <b>Household Name:</b>                                  |  |
| <b>Phone Number:</b>                                    |  |
| <b>House address or Location:</b>                       |  |
| <b>Filter Number:</b>                                   | <b>How long have you been using the filter?</b>                  |
| <b>How many people use the filter?</b>                  | <b>How many times to you pour water into the filter per day?</b> |

**What is the source water that is poured into the filter?**







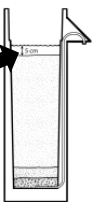

|  |               |           |             |           |      |
|--|---------------|-----------|-------------|-----------|------|
| <input type="checkbox"/> OR <input type="checkbox"/> |               |           |             |           |      |
|  | River or Pond | Open Well | Closed Well | Tap Stand | Pump |

**Besides the biosand filter, what other methods do you use to treat your water?**

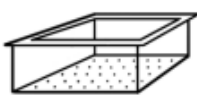
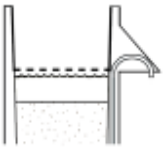
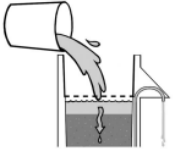
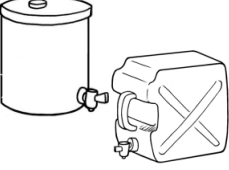
|  |              |          |         |          |       |
|--|--------------|----------|---------|----------|-------|
| <input type="checkbox"/> OR <input type="checkbox"/> |              |          |         |          | Other |
|  | No Treatment | Settling | Boiling | Chlorine |       |

**Does anyone in the home suffer from the following?**

|  |          |              |                |               |       |
|--|----------|--------------|----------------|---------------|-------|
| <input type="checkbox"/> OR <input type="checkbox"/> |          |              |                |               | Other |
|  | Diarrhea | Stomach Ache | Skin Infection | Eye Infection |       |

| Operating Parameters                                  |  |  |   |  |
|---|--|--|---|--|
| ✓<br>OR<br>✗  | 4-6 cm<br><br>Standing water depth = 4 to 6 cms | <br>Flow rate             | <br>BSF used once a day?              | <br>Diffuser is in good condition |
|   |  | _____ mL/min<br>OR<br>_____ min:sec<br>to fill 1 L bottle  |   |  |
| ✓<br>OR<br>✗  | <br>Sand is flat and level                      | <br>Source water is clear | <br>Clean safe storage container used | <br>No leaks                      |
|   |  |  |   |  |
| End User Competence                                   |  |  |   |  |
| USER SHOWED ME CORRECTLY HOW TO :<br><br>✓<br>OR<br>✗ | <br>Clean Filter Container                    | <br>Swirl and Dump      | <br>Clean Lid and Diffuser          | <br>Clean Safe Water Container  |
|   |  |  |   |  |
| USER SHOWED ME CORRECTLY HOW TO :<br><br>✓<br>OR<br>✗ | <br>Use the filter                            |  |   |  |
|   |  |  |   |  |

## Appendix 2 - Troubleshooting Guide

|   |       |
|---|-------|
| Construction Troubleshooting Scenarios.....             | A2-1  |
| Installation Troubleshooting Scenarios.....             | A2-2  |
| Operation Troubleshooting Scenarios .....               | A2-3  |
| Construction Troubleshooting Scenarios Answer Key ..... | A2-5  |
| Installation Troubleshooting Scenarios Answer Key ..... | A2-9  |
| Operation Troubleshooting Scenarios Answer Key .....    | A2-13 |
| Who to Contact if You Have Problems .....               | A2-19 |



## **Construction Troubleshooting Scenarios**

- 1. Your filter container breaks during de-molding.**
- 2. Your mold is bending during de-molding.**
- 3. Your tubing won't stick to the top of the inner mold while pouring the filter.**
- 4. Your filter has cracks at the bottom.**
- 5. Your filter has cracks or leaks in the walls.**
- 6. The nose of the filter is broken.**
- 7. The mold sticks to the concrete during de-molding.**
- 8. The outlet tube is plugged with concrete.**
- 9. Chunks break off the top of the filter.**
- 10. The filter's surface is full of holes, but it doesn't leak.**
- 11. Paint is not sticking to the filter.**

## Installation Troubleshooting Scenarios

1. **Filters are breaking during transport.**
2. **The family wants the filter installed outside.**
3. **There isn't enough gravel to make 5cm depth.**
4. **There isn't enough sand.**
5. **The water coming out of the filter has leaves, plant pieces or dirt in it.**
6. **The water coming out of the filter smells like chlorine.**
7. **The standing water is more than 6 cm deep.**
8. **The standing water is less than 4 cm deep.**
9. **The flow rate is less than 0.4 litres/minute.**
10. **The flow rate is much more than 0.4 litres/minute.**
11. **There is no water flowing out of the filter when water is poured in the top.**
12. **You only have time to install filters in people's homes without explaining how to use the filter.**
13. **People don't seem interested in the filters, disinfection or safe storage containers.**



## Operation Troubleshooting Scenarios

1. Water leaving the filter is very turbid (dirty).
2. The standing water is more than 6 cm deep.
3. The standing water is less than 4 cm deep.
4. You open the lid and remove the diffuser, but you can't see any water.
5. Filter looks fine, but the flow rate is too fast.
6. Filter looks fine, but the flow rate is too slow.
7. Filter looks fine, but there is no flow.
8. The filtered water has a bad taste.
9. A filter was installed yesterday and is suddenly clogged this morning.
10. During a follow-up visit, you notice that there are indents and craters in the sand.
11. You only have time to install filters in people's homes without explaining how to use the filter.
12. People don't seem interested in the filters, disinfection or safe storage containers.
13. Filter looks fine, no obvious problems. The family tells you that they are cleaning the filter once a week. What is wrong?
14. Filter looks fine, but people are still getting sick.
15. Food is stored inside the filter.
16. The users want to move the filter.
17. The family is using the same bucket for collecting the source water and collecting the filtered water.



## Construction Troubleshooting Scenarios Answer Key

### 1. Your filter container breaks during de-molding or has significant cracks.

There may be a problem with the shape of your mold or the welding. Compare your mold with CAWST's design to see how different it is. You may have to talk to a welder to solve the problem. If differences aren't significant, you may find that concrete is attaching to rough parts of the mold or rivets in the mold. In this case, you will need to sand the mold smooth with sand paper for metal or steel wool.

Concrete boxes can also break during de-molding if it is cool at night and they haven't been given enough time to cure. The concrete is still very weak when you try to de-mold. Try leaving the concrete in the molds for more than 24 hours before de-molding.

### 2. Your mold is bending during de-molding.

Usually this means you didn't use enough oil. Try tapping the mold with a rubber hammer while you are de-molding. If you can't remove the mold without bending it, try breaking up the concrete and destroying the filter container. It is better to lose a filter container than a mold. Use your judgment. If forcing the inner mold out will cause damage to the mold, then break the filter container.

Also, check to see that the mold is made from steel that is 3 mm thick. Thinner metal will bend more easily and the mold will be damaged. Put the mold aside, and when it is clean check it for rough seams and rough surfaces that might make the concrete stick to the mold. If there are rough places, try to sand them smooth. The metal must be smooth or else the concrete will stick to the metal.

### 3. Your filter has cracks at the bottom.

It is very common to have cracks at the bottom of the filter. The bottom of the filter is at the top of the mold when you are pouring the filter (until you de-mold and flip the filter over). When the mold is full of concrete, make sure you stick a trowel into the wet concrete all around the top of the mold. This will help the concrete stick together better in the bottom of the filter. After you are finished pouring the filter, wait 30-45 minutes and then go back and stick a trowel into the wet concrete again, all around the top of the mold. Then smooth the top of the wet concrete again, so the filter has a flat bottom. Place damp sand on top of the base to prevent the concrete from drying out too quickly as it sets.

### 4. Your filter has cracks or leaks in the walls.

The concrete may be too dry. Try adding more water to the concrete mix. Make sure there are no rocks bigger than 12 mm in the concrete mix. Big rocks will go all the way through the walls of the filter, making cracks and causing leaks.

You may need to do more compacting with the wooden/metal bar and bang more with the rubber hammer while you are pouring the concrete into the mold. Pour the concrete in slowly -

one scoop at a time - and compact it a lot with the bar. Have someone hitting the outside of the mold with the rubber hammer, starting at the bottom and working the way up to the top of the mold, then start at the bottom again. Do this a lot on all 4 sides of the mold as you are pouring concrete in slowly. The less air bubbles in the concrete, the fewer holes and leaks there will be.

You may also need to wait longer before de-molding. Filters can crack when they are de-molded too soon, and the concrete is still weak. Wait a few hours longer until the concrete is stronger.

Small leaks can be repaired with cement paste. Chip away some of the concrete around the leak, and then fill the leak and surrounding area with cement paste. This may work best if you repair the area around the leak on both the inside and the outside of the filter. Let the new cement dry completely before painting, transporting or installing it.

#### **5. The nose of the filter is broken.**

Be very careful when removing the nose plate of the mold. Bang the nose lightly on the outside of the mold as you are removing the mold. Also try putting more oil on the mold at the nose. While pouring the concrete into the mold, bang on the nose with the rubber hammer to make sure enough concrete gets into the nose. You should see gray water start to come out of the nose plate.

#### **6. Chunks break off the top of the filter.**

Be very careful with the filter after de-molding – the concrete is very fresh and weak. Do not grab the filter by the top to move it. The concrete will get stronger over the next 7 days after de-molding. If the concrete is still breaking, try leaving the filters in the molds longer before de-molding, so the concrete is stronger when you de-mold.

Your concrete may be too wet when you pour the mold. Try using less water in the mix. More water makes concrete weaker.

#### **7. The mold sticks to the concrete during de-molding.**

Usually this means you didn't use enough oil. Try tapping the mold with a rubber hammer while you are de-molding. If you can't remove the mold without bending it, try breaking up the concrete and destroying the filter container. It is better to lose a filter container than a mold. Use your judgment. If forcing the inner mold out will cause damage to the mold, then break the filter container.

Put the mold aside, and when it is clean check it for rough seams and rough surfaces that might make the concrete stick to the mold. If there are rough places, try to sand them smooth. The metal must be smooth or else the concrete will stick to the metal.

#### **8. Your tubing won't stick to the top of the inner mold while pouring the filter.**

Do not oil the top of the inner mold, or the tape will not stick to the top of the inner mold. Try to find very sticky tape. You may have to use a lot of tape.

**9. The outlet tube is plugged with concrete.**

Plug the outlet tube at the nose with tape or a cloth so no concrete gets into the tube. Put a piece of tape over the end of the outlet tube that is taped to the mold, so no concrete gets into the tube. After de-molding, you need to be able to reach inside the filter all the way to the bottom, and pull out all the tape. Be careful reaching into the filter as the concrete is still weak.

**10. The filter's surface is full of holes but it doesn't leak.**

There are air bubbles in the concrete. You need to do more compacting with the wooden/metal bar and bang more with the rubber hammer while you are pouring the concrete into the mold. Pour the concrete in slowly - a scoop at a time - and compact it a lot with the bar. Have someone hitting the outside of the mold with the rubber hammer, starting at the bottom and working the way up to the top of the mold, then start at the bottom again. Do this a lot on all 4 sides of the mold as you are pouring concrete in slowly.

You can also try adding more water to the concrete mix. Adding more water will make a smoother finish on the outside of the filter, but it will also make the concrete weaker.

**11. Paint is not sticking to the filter.**

Try using a concrete primer paint first. Primer paint should stick better to concrete. Then apply the water-based paint. Paint only the outside of the filter. Do not paint the inside of the filter so no chemicals get into the drinking water.



## **Installation Troubleshooting Scenarios Answer Key**

### **1. Filters are breaking during transport.**

Be very careful when moving filters. Try cushioning filters in the truck using sand bags, sacks or other materials. Make sure filters have cured for at least 7 days after de-molding before moving them, so the concrete is strong. If the filters are still breaking easily, try using less water in the concrete mix (water makes concrete weak). Also try buying better quality cement.

### **2. The family wants the filter installed outside.**

An acceptable location for a filter is somewhere where it will be safe, where animals cannot touch it, where it will not get bumped or knocked over. It should be under a roof to keep it clean and cool. It should be accessible and easy to use for the family. Filters are usually installed in the kitchen, but may also be in another room, on the porch, or in a protected and covered area outside.

### **3. There isn't enough gravel to make 5cm depth.**

It is important that there is enough gravel, so that sand and small gravel do not get into the outlet tube and block it. Keep 1 or 2 extra bags of each type of gravel in the truck and bring them with you on every installation, so that you can add more gravel to a filter if you need to.

### **4. There isn't enough sand.**

The sand is the most important part of the filter, and you need the correct amount of sand. You need to put enough sand in the filter so that there is only 5 cm between the top of the sand and the end of the outlet tube. If there isn't enough sand, the standing water will be too deep. The biolayer that lives in the top of the sand will not get any air, and it will die. Also, if the total height of the sand inside the filter is not enough, it will not do a good job of trapping pathogens. Keep 1 or 2 extra bags of sand in the truck and bring them with you to every installation, so that you can add more sand to a filter if you need to.

### **5. The water coming out of the filter has leaves, plant pieces or dirt in it.**

This is normal during the flushing period of the filter installation. If, however, the water is still turbid after over 60 litres of flushing (about 5 filter runs), or if it is still turbid the next morning after an installation, this means that your sand needs to be washed more. If washing your sand more would drastically increase the flow rate of your filter, this means that finer sand (smaller grains) needs to be used. You can try to find another sand source. Or use a finer mesh sieve to get smaller grains from your existing sand source.

Your filter may also produce turbid water if your gravel is not washed clean enough. A good test is to run water through a filter with only the gravel layers installed. Capture water in a glass jar to visually check that it has very low turbidity. Keep flushing buckets of water through the filter, and the water should become clear.

**6. The water coming out of the filter smells like chlorine.**

The chlorine smell is probably from disinfecting the outlet tube when you installed the filter. CAWST no longer recommends disinfecting the outlet tube with chlorine. The smell may also be coming from the sand if you washed the sand in bleach to clean it (if you had to use river sand for filtration sand). You need to flush the filter with more water. Pour a total of 60-80 litres of water into the top of the filter (about 5 to 7 runs), until the water is clear and does not smell of chlorine.

**7. The standing water is more than 6 cm deep.**

This is a problem because it means that not enough oxygen will be getting to the biolayer. One possible cause is that the filter is clogged. To test if this is the case, fill the filter to the top and measure its flow rate. If the flow rate is close to 0.4 L/min, the filter is not clogged.

The next thing to check is the outlet tube length. The standing water level in the filter is controlled by a siphoning effect in the tube, meaning that the water will rest at the same level as the end of the tube. If the tube is not cut evenly, then it will rest at the level of the highest edge of the tube. If the tube is less than 1 cm long (measure from the end of the tube up to the bottom of the filter's nose), then the tube is probably too short, making the water level inside the filter too high.

If the tube length is normal (1.5 to 2 cm or  $\frac{9}{16}$ " to  $\frac{13}{16}$ " long), then the problem may be the tube's internal diameter. The internal diameter of the tube should be  $\frac{1}{4}$ ". Anything larger, and there is a risk that the water flowing through the tube won't fill the tube volume as the filter reaches the end of its run. If this happens, air can enter the tube, causing the siphon to break and leaving the water level too high in the filter.

If the tube looks ok, there may not be enough sand in the filter. If the sand level is too low, the standing water above the sand will be too deep. Do a Swirl and Dump and add more sand to the top of the filter.

**8. The standing water is less than 4 cm deep.**

The standing water should be at least 4-5 cm deep. If it is too shallow, the biolayer may dry out if the water evaporates, or the biolayer may be disturbed by water drops hitting it when water is poured into the top of the filter. Check the length of the outlet tube. The water surface should be at the same level as the end of the outlet tube. If the outlet tube can be cut shorter, cut it off so that the water level is 5 cm deep. If the tube cannot be cut shorter, you have to remove some sand.

**9. The flow rate is less than 0.4 litres/minute.**

You haven't washed the sand enough. There is too much very fine dust in the sand, and it is clogging the filter. The fine dust may wash out as you flush the filter. Try pouring 60 litres (about 5 buckets) through the filter. If the flow rate is acceptable for the user, leave the filter as it is. Water treatment will be just as good or better with a slow flow rate. If the flow rate does not increase or is too slow for the user, remove all the sand. Re-install the filter with new sand that has been washed more and tested in a filter at the production site. Tell the people responsible for washing the sand so they know they should wash the sand more.



**10. The flow rate is much more than 0.4 litres/minute.**

You have washed the sand too much. Try washing the sand less. If changing the number of times you wash the sand does not change the flow rate, you need to use finer sand with smaller grains. You can try to find another sand source. Or use a finer mesh sieve to get smaller grains from your existing sand source. Filters with flow rates that are much more than 0.4 litres/minute should be reinstalled. Take out all the sand, and put in new sand that has been washed less and tested in a filter at the production site. Tell the people who wash the sand, so they know they should wash the sand less.

**11. There is no water flowing out of the filter when water is poured in the top.**

Look in the outlet tube to see if it is blocked. Try blowing into the end of the outlet tube – if no air goes in, the tube may be completely blocked. If the tube is blocked and you cannot unblock it, you will have to take all the sand and gravel out of the filter. If you cannot solve the problem, take the filter back to the shop and install a new one in the home. You can try to unblock the tube using compressed air. If the tube cannot be unblocked, it will have to be thrown out. All filters should be checked after they are de-molded to make sure the tube is not blocked with concrete. If several tubes are getting blocked, you may have pieces of gravel that are too small in your large drainage gravel (the bottom layer). Try using a smaller mesh sieve for your drainage gravel. The holes in the sieve should be 6mm (1/4 inch). The wires in the mesh should be woven together so that the wires cannot move and make bigger holes.

**12. You only have time to install filters in people's homes without explaining how to use the filter.**

Do not install filters in people's homes without providing education and training on how to use and maintain the filters. As project implementers, you have a responsibility to ensure that households have the tools and support to be able to continue using their filter. This means having enough time for follow-up visits to ensure that filter users are knowledgeable.

**13. People don't seem interested in the filters, disinfection or safe storage containers.**

There may be a lot of scepticism over any new technology you plan to introduce into a community. People in developing communities have often been promised a number of inventions or technologies from outside of their community, with sometimes little or no follow-up. CAWST recommends finding out what people in the community want and what their preferences are, and promoting the technology in a way that will appeal to them personally.

CAWST recommends that you work closely with individuals from the community where you are working. If you are working in a country that is different than your own, working with a native of the country you're working in can help, but does not always mean the project will be successful. If that person has significant cultural, economic, or geographic differences from the community where you plan to work, then seek other people from the community itself to work with.

There is also a possibility that people will accept one technology (such as a filter) without following the entire water treatment process from start to finish (sedimentation, filtration and disinfection). It is important to give households all the tools and support needed to best treat their water, but you cannot force individuals to always follow your recommendations. Repeated follow-up visits are important to build relationships, help people to accept and understand the new technology, and to help them use it correctly.



## Operation Troubleshooting Scenarios Answer Key

### 1. Water leaving the filter is very turbid (dirty).

This is normal during the flushing period of the filter installation. If, however, the water is still turbid after over 60 litres of flushing (about 5 filter runs), or if it is still turbid the next morning after an installation, this means that your sand needs to be washed more. If washing your sand more would drastically increase the flow rate of your filter, this means that finer sand (smaller grains) needs to be used. You can try to find another sand source. Or use a finer mesh sieve to get smaller grains from your existing sand source.

Your filter may also produce turbid water if your gravel is not washed clean enough. A good test is to run water through a filter with only the gravel layers installed. Capture water in a glass jar to visually check that it has very low turbidity. Keep flushing buckets of water through the filter, and the water should become clear.

### 2. The standing water is more than 6 cm deep.

This is a problem because it means that not enough oxygen will be getting to the biolayer. One possible cause is that the filter is clogged. Fill the filter to the top and measure its flow rate. If the flow rate is close to 0.4 L/min, the filter is not clogged. If the flow rate is very slow, do a Swirl and Dump until the flow rate is 0.4 L/min. When the filter stops flowing, check the standing water depth again.

The next thing to check is the outlet tube. Make sure there is not a tap on the outlet. A closed tap will keep too much water in the filter. If there is a tap, remove it and explain to the family that the filter will not work well with a tap on it. If there is no tap, check the length of the outlet tube. The standing water level in the filter is controlled by a siphoning effect in the tube, meaning that the water will rest at the same level as the end of the tube. If the tube is not cut evenly, then it will rest at the level of the highest edge of the tube. If the tube is less than 1 cm long (measure from the end of the tube up to the bottom of the filter's nose), then the tube is probably too short, making the water level inside the filter too high.

If the tube length is normal (1.5 to 2 cm or  $\frac{9}{16}$ " to  $\frac{13}{16}$ " long), then the problem may be the tube's internal diameter. The internal diameter of the tube should be  $\frac{1}{4}$ ". Anything larger, and there is a risk that the water flowing through the tube won't fill the tube volume as the filter reaches the end of its run. If this happens, air can enter the tube, causing the siphon to break and leaving the water level too high in the filter.

If the tube looks ok, there may not be enough sand in the filter. If the sand level is too low, the standing water above the sand will be too deep. Do a Swirl and Dump and add more sand to the top of the filter. Tell the family it will take another 30 days for the biolayer to develop on the top of the new sand. They should use a disinfection method like chlorine with the filtered water for the next 30 days.

### **3. The standing water is less than 4 cm deep.**

The standing water should be between 4 cm and 6 cm deep. If it is too shallow, the biolayer may dry out if the water evaporates, or the biolayer may be disturbed by drops hitting it when water is poured into the top of the filter. Check the length of the outlet tube. The water surface should be at the same level as the end of the outlet tube. If the outlet tube can be cut shorter, cut it off so that the water level is 5 cm deep.

If the tube cannot be cut shorter, you have to remove some sand. Tell the family it will take another 4 weeks for the biolayer to develop on the top of the new sand. They should use a disinfection method like chlorine with the filtered water for the next 4 weeks.

### **4. You open the lid and remove the diffuser, but you can't see any water.**

If the filter hasn't been used in a few days, all of the water in the top of the filter could have evaporated. Ask the users when they used the filter last. How often do they use it?

Check your records and ask the users if the filter was installed correctly – has the water level always been below the sand? Perhaps there was too much sand installed in the filter. Some sand will have to be removed so the top of the sand is about 5 cm below the end of the outlet tube.

Check to make sure there is not a hose attached to the spout. If there is a hose, it will make all the water drain out of the filter.

Check and ask the users if the filter leaks. Small leaks can be repaired with cement paste (mix a little cement and water together). Chip away some of the concrete around the leak, and then fill the leak and surrounding area with cement paste.

If there is no water above the sand, you must refill the filter with water. You cannot refill the filter by pouring a bucket of water into the top of the filter. This may create air bubbles inside the filter, which might stop the filter from working correctly. You must refill the filter with water from the bottom – through the outlet tube.

Take out the diffuser so you can see the top of the sand. Get a hose that fits over the outlet tube, and a funnel that fits into the hose. Hold the hose and funnel up high, above the top of the sand. Slowly pour water into the funnel. Pour water into the funnel and let it drain into the tube, until you see the water level in the top of the filter rising. When the water level is about 5 cm above the top of the sand, you can remove the hose and funnel. Put the diffuser back in, and pour a bucket of water into the filter. Measure the flow rate.

Explain to the users that they must use the filter at least once every day. If they go away, they must ask someone to pour water into the filter every day so the sand does not dry out. If the sand dries out again, they must call your organization so a technician can come and re-fill the filter from the bottom again.

### **5. Filter looks fine, but the flow rate is too fast.**

Check your records and ask the family if the flow rate was always this fast. If not, ask the family if they have taken the sand out of the filter, or changed it in any way. Ask the family how they are maintaining the filter and the sand.

If the flow rate was always fast, the sand has been washed too much. Try washing the sand less. If changing the number of times you wash the sand does not change the flow rate, you need to use finer sand with smaller grains. You can try to find another sand source. Or use a finer mesh sieve to get smaller grains from your existing sand source.

Filters with flow rates that are much more than 0.4 litres/minute should be reinstalled. Take out all the sand, and put in new sand that has been washed less and tested in a filter at the production site. Tell the family it will take another 30 days for the biolayer to develop on the top of the new sand. They should use a disinfection method like chlorine with their filtered water for the next 30 days.

Be sure to test the filtration sand before installing filters in people's homes. A filter that is not working properly from the beginning might harm the reputation of your project. It may also be possible that people with different sand washing techniques produce different types of washed sand. Everyone has a different style of sand washing which may change results slightly. You might find that having one or two designated sand-washers might prevent this from happening.

#### **6. Filter looks fine, but the flow rate is too slow.**

Check your records and ask the family if the flow rate was always this slow. If not, ask them how they are maintaining the filter and the sand. They may only need to do a Swirl and Dump. If this does not increase the flow rate, check if the outlet tube is partly blocked.

If the flow rate was always very slow, the sand may not have been washed enough. If the flow rate is acceptable for the user, leave the filter as it is. Water treatment will be just as good or better with a slow flow rate. If the flow rate is not acceptable to the user and doing a Swirl and Dump does not increase the flow rate, and the tube is not blocked, then remove all the sand. Reinstall the filter with new sand that has been washed more and tested in a filter at the production site. Tell the family it will take another 30 days for the biolayer to develop on the top of the new sand. They should use a disinfection method like chlorine with their filtered water for the next 30 days.

Be sure to test the filtration sand before installing filters in people's homes. A filter that is not working properly from the beginning might harm the reputation of your project. It may also be possible that people with different sand washing techniques produce different types of washed sand. Everyone has a different style of sand washing which may change results slightly. You might find that having one or two designated sand-washers might prevent this from happening.

#### **7. Filter looks fine, but there is no flow.**

Ask the users when the filter stopped flowing. What was the flow rate like before it stopped? Had they changed how they used the filter? Did they change water sources? Did they go away for awhile? Did anything happen to the filter? Did they move the filter?

First, check if the outlet tube is blocked. Try blowing into the tube or using an air pump to unblock the tube.

Look at the diffuser to see if the holes are clogged. The diffuser may need cleaning.

Try doing a Swirl and Dump. If the source water that is being poured into the filter is very turbid (dirty), then the users should settle the dirt out of the water first. They should let the water sit in a bucket for a few hours, and the dirt will sink to the bottom. This will help remove the fine particles which are clogging the filter.

### **8. The filtered water has a bad taste.**

The biosand filter doesn't normally produce flavoured water. It could be that the end users are experiencing a different taste than they are used to.

A bad taste could also be coming from oil residue leftover from the construction process. It is important to clean the filters out thoroughly with a little soap and a long brush before installation. Oil residue may take weeks to flush out a filter with regular use and can taste quite unpleasant. Make sure each filter is flushed with about 60 litres of water (about 5 runs) when it is installed to get rid of any dirt or chlorine that is still in the filter or tube.

If the users tell you the bad taste just started happening, it could be coming from the source water. It could be seasonal. Ask the user if they can use a different water source for a few days, and see if the bad taste goes away.

If the problem cannot be solved, take all the sand and gravel out of the filter. Reinstall the filter with fresh, clean, washed sand and gravel.

### **9. A filter was installed yesterday and is suddenly clogged this morning.**

First of all, check if the outlet tube is blocked. Try blowing into the tube or using an air pump to unblock the tube.

Try doing a Swirl and Dump. If the source water that is being poured into the filter is very turbid (dirty), then the users should settle the dirt out of the water first. They should let the water sit in a bucket for a few hours, and the dirt will sink to the bottom. This will help remove the fine particles which are clogging the filter.

### **10. During a follow-up visit, you notice that there are indents and craters in the sand.**

This is likely caused by the diffuser either being too small or floating up when water is poured into the filter. Both of these situations mean that water is going around the diffuser (rather than through the holes) and hitting the sand with force. Measure the inside of the filter container and replace the diffuser for the use with ones that fits tightly. If the diffuser floats when water is poured in (possible with some plastic diffuser plates), try putting a rock on top of the diffuser plate. It is also recommended that users pour their water into the reservoir slowly to minimize the impact of the water.

### **11. You only have time to install filters in people's homes without explaining how to use the filter.**

Do not install filters in people's homes without providing education and training on how to use and maintain the filters. As project implementers, you have a responsibility to ensure that households have the tools and support to be able to continue using their filter. This means having enough time for follow-up visits to ensure that filter users are knowledgeable.

**12. People don't seem interested in the filters, disinfection or safe storage containers.**

There may be a lot of scepticism over any new technology you plan to introduce into a community. People in developing communities have often been promised a number of inventions or technologies from outside of their community, with sometimes little or no follow-up. CAWST recommends finding out what people in the community want and what their preferences are, and promoting the technology in a way that will appeal to them personally.

CAWST recommends that you work closely with individuals from the community where you are working. If you are working in a country that is different than your own, working with a native of the country you're working in can help, but does not always mean the project will be successful. If that person has significant cultural, economic, or geographic differences from the community where you plan to work, then seek other people from the community itself to work with.

There is also a possibility that people will accept one technology (such as a filter) without following the entire water treatment process from start to finish (sedimentation, filtration and disinfection). It is important to give households all the tools and support needed to best treat their water, but you cannot force individuals to always follow your recommendations. Repeated follow-up visits are important to build relationships, help people to accept and understand the new technology, and to help them use it correctly.

**13. Filter looks fine, no obvious problems. The family tells you that they are cleaning the filter once a week. What is wrong?**

Ask the family to explain how they clean the filter. Do they clean the outlet tube, wash the diffuser, and do the Swirl and Dump? Do they do the Swirl and Dump every week? Why are doing it that often? Perhaps they misunderstood the training, or maybe the flow rate slows down that quickly. If the flow rate slows down every week, the source water is too turbid. Suggest they let the water stand in a bucket for a few hours to settle out the dirt, and then pour the cleaner water into the filter. Then they won't have to do the Swirl and Dump (and disturb the biolayer) so often.

**14. Filter looks fine, but people are still getting sick.**

There are many ways people can get sick. Check if they are using the same bucket for collecting source water and filtered water. Check if the water may be getting contaminated after filtration. Are they using a safe storage container? Are there other sanitation or hygiene issues? How often do they use the filter? Do they sometimes drink untreated water? Check the 8 key filter performance points to make sure the filter is working properly.

**15. Food is stored inside the filter.**

Users sometimes store food inside the filter because it is cool. But the inside of a filter is very dirty – it collects dirt and pathogens! Food will get contaminated. The food will also attract bugs to the filter.

**16. The users want to move the filter.**

Filter should not be moved once they are installed. They are very heavy. When you move it, sand and gravel may shake down and block the outlet tube. There may be problems with the

filter after it is moved. The flow rate may become very slow if you move a filter, because the sand and gravel will shake down and pack tightly together. A technician must reinstall the filter if it is moved or if all the sand is taken out.

**17. The family is using the same bucket for collecting the source water and collecting the filtered water.**

Users must have a separate safe storage container that is used only for filtered water. If the same bucket is used for unfiltered water, drops of unfiltered water that are left in the bucket can contaminate the whole bucket of filtered water and make the family sick.

To keep filtered water safe, keep it covered with a lid and pour it from the container instead of dipping cups into the container.



## Who to Contact if You Have Problems

If you have a problem that you can not solve, who will you ask?

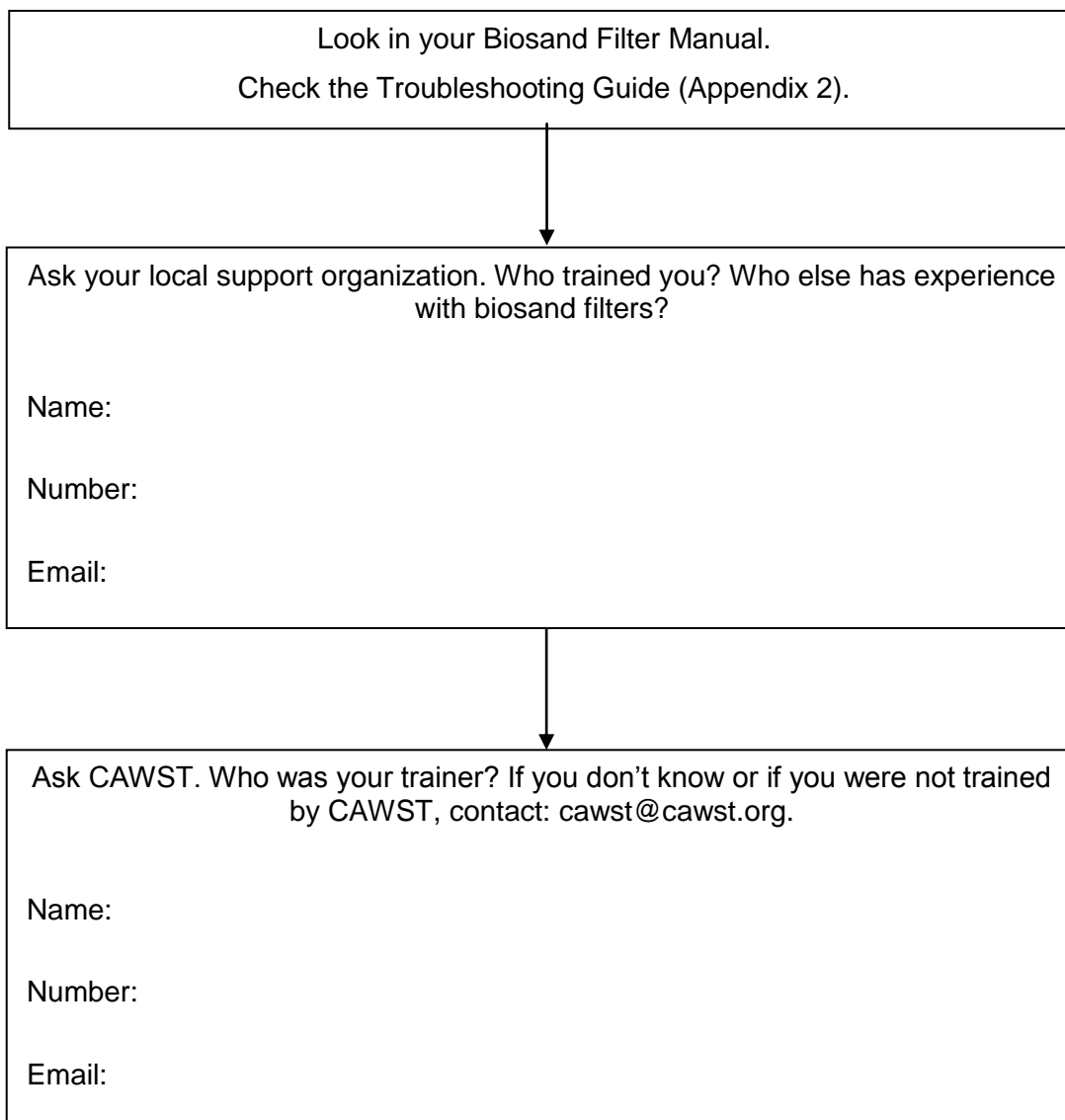



## Appendix 3 - Diffuser and Lid Designs

|  |       |
|--|-------|
| Option 1 – Metal Diffuser Box and Lid.....         | A3-1  |
| Option 2 – Tapered Metal Diffuser Box and Lid..... | A3-9  |
| Option 3 – Metal Diffuser Plate .....              | A3-10 |
| Option 4 – Acrylic/Plastic Diffuser Plate .....    | A3-11 |
| Option 5 – Wooden Lid .....                        | A3-12 |



## Option 1 – Metal Diffuser Box and Lid

### Tools:

- Long straight edge or ruler (120 cm/48" or longer)
- Tape measure
- Square or right angle
- Marker
- Metal cutters suitable for 28 gauge galvanized sheet metal
- Drill with 3 mm (1/8") drill bit
- Hammer
- Folding tool (e.g. bending brake)
- Anvil or steel plate set in a vice to hammer sheet metal against

### Materials:

- 1 sheet of galvanized sheet metal 2438 mm x 1219 mm (4' x 8'), 28 gauge thick (0.46 mm or 0.018")



Diffuser box and lid with handle (optional)

**Note:** Caution! Be careful of sharp edges and wear hand protection if needed.

### Steps:

1. Lay out the sheet metal and mark lines for cutting the outline of each piece according to the dimensions shown on Figure 1.
2. Cut out the side walls, bottoms, lids and corner pieces.
3. Measure and mark cut lines (solid line) and fold lines (dashed) for each piece according to dimensions provided in:
  - i. Figures 2 & 3: Filter lid
  - ii. Figures 4 & 5: Side walls and corner pieces
  - iii. Figures 6 & 7: Bottom piece
4. Cut along solid lines and fold along dashed lines as shown in the folding sequence provided in each Figure.

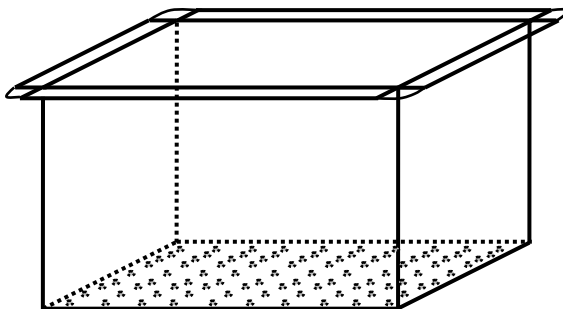

Diffuser Box

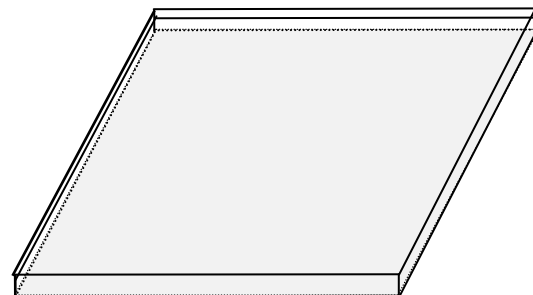

Filter Lid

# Figure 1

## Layout for cutting sheet metal for 4 diffuser boxes

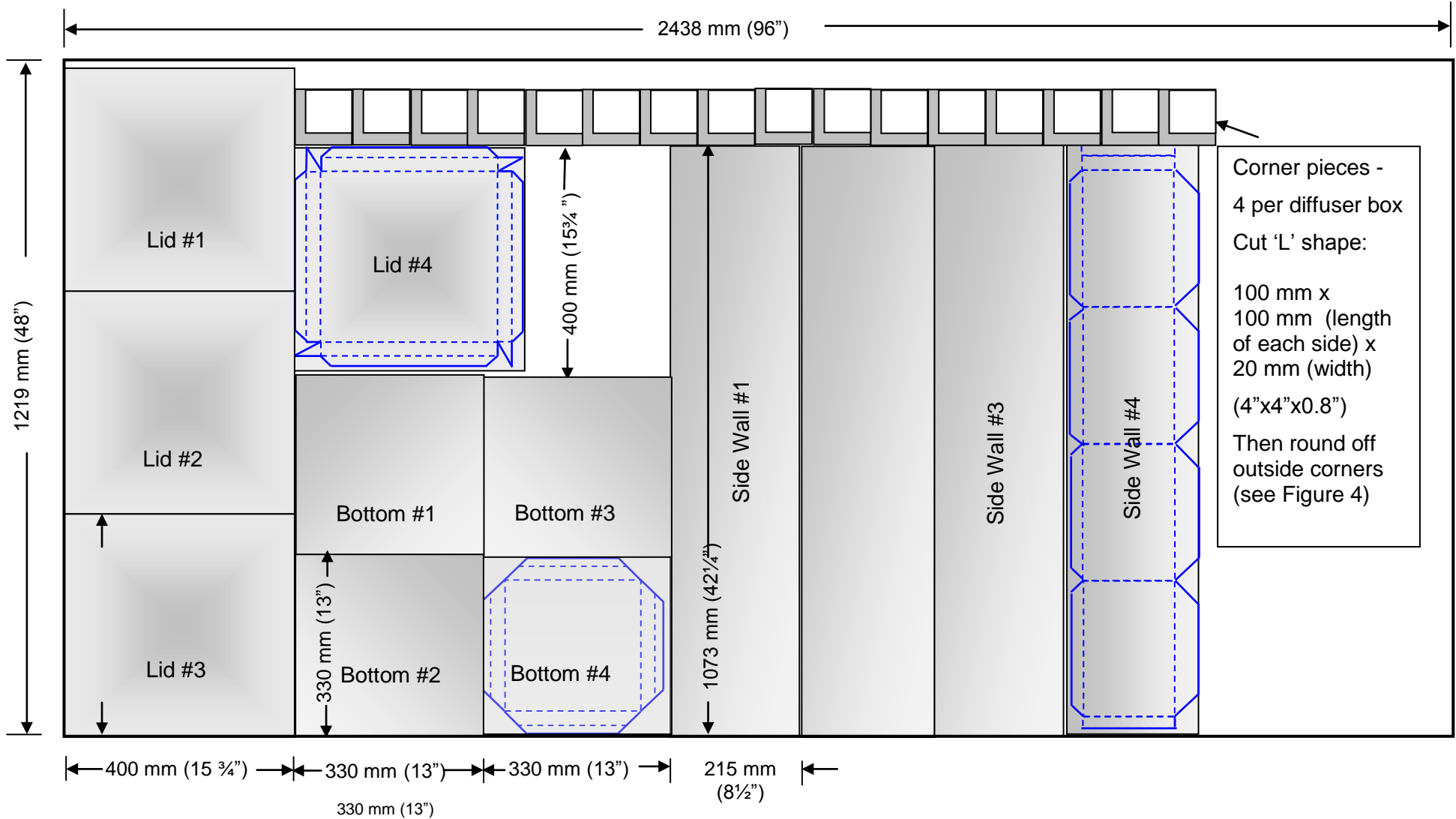

**Figure 2**  
Filter Lid

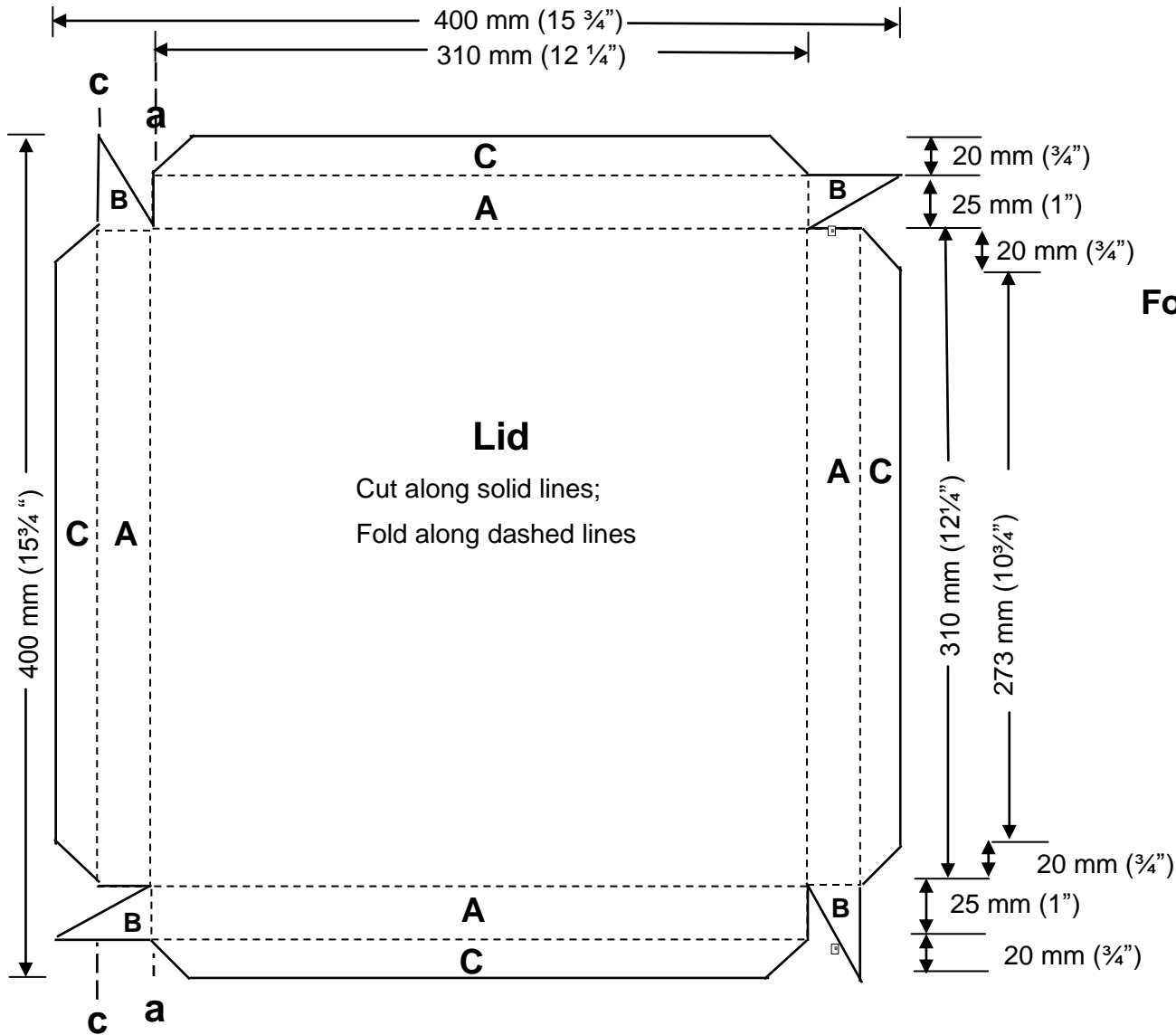

**Folding Sequence for Lid:**

1. Fold four **A** flanges down along bend line **a - a**.
2. Fold flaps **B** 90° inward so they lie alongside (parallel to) flange **A**.
3. Fold flange **C** upwards along **C - C** and press to lock flaps **B** in place.

### Figure 3

Folding Detail for Filter Lid

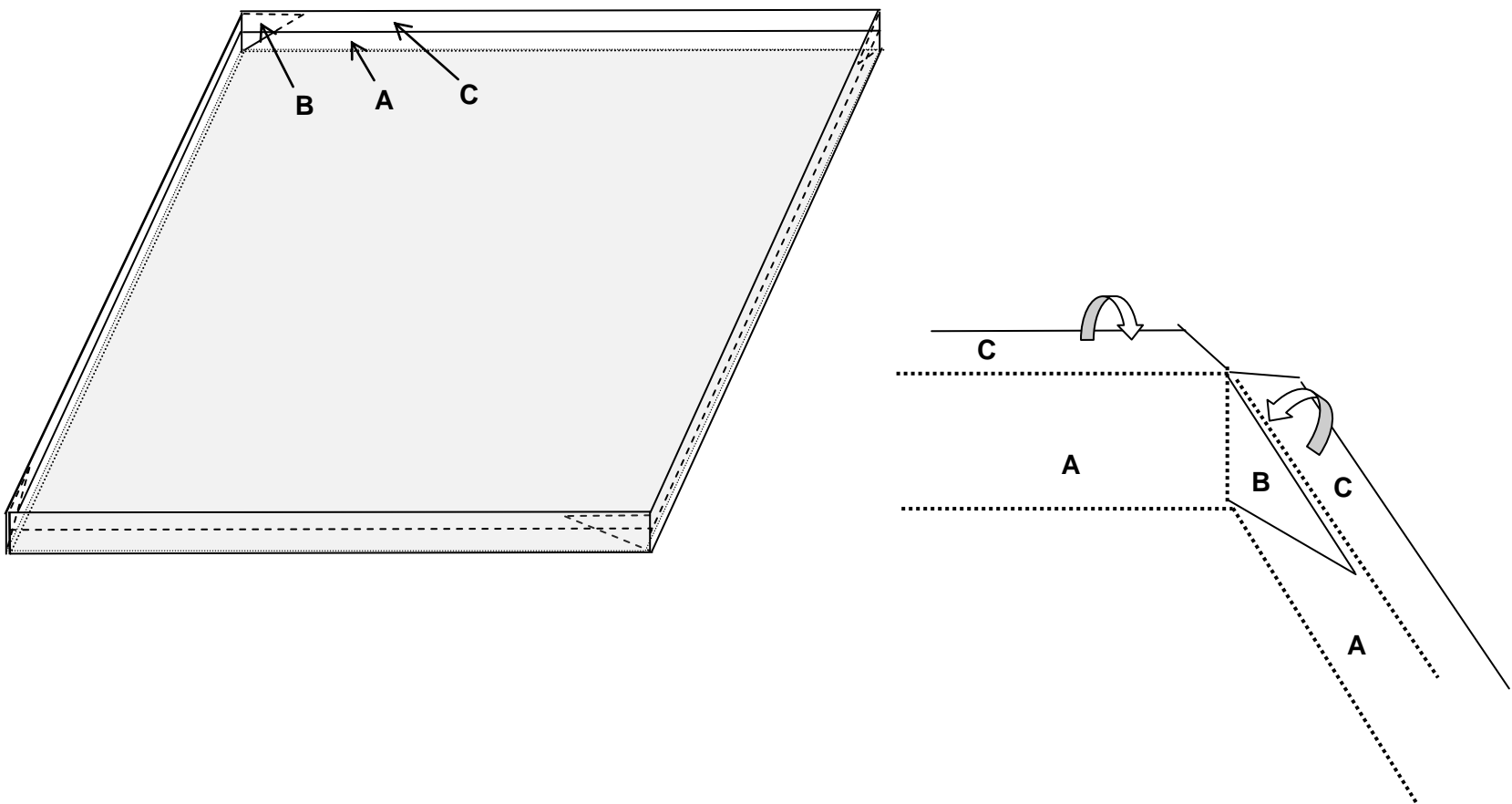



## Figure 4 Side Walls and Corner Pieces

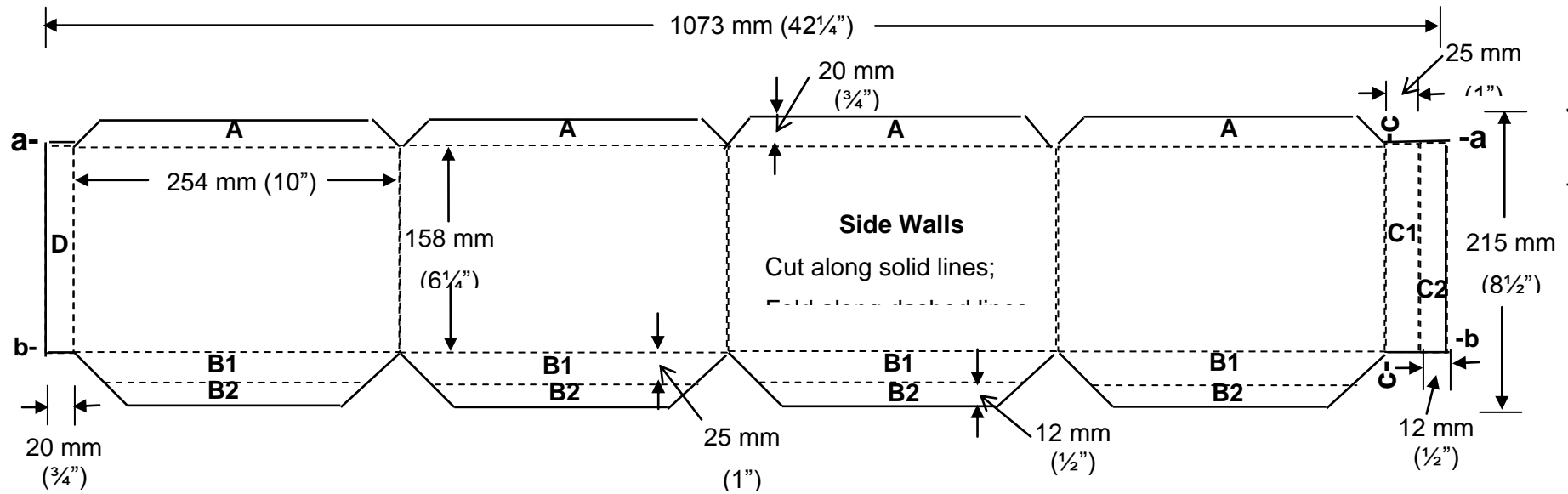

### Folding Sequence for Side Walls

1. Fold flanges **A** to 90° along bend line **a-a**. These flanges will be on the outside of the box and attach to the Bottom Piece.
2. Fold flange **B** (tabs **B1** and **B2**) down 90° along **b-b**
3. Fold **B2** (outer tab of flange **B**) to 90°. This **B** flange will form a lip around the outside of the box. This lip will sit on the top of the walls of the filter to suspend the box in the filter. Tab **B2** will be on the underside of the lip of the box.
4. Fold **C2** (outer tab of flange **C**) to 90°. This flange will be on the outside of the box.
5. Fold flange **D** to 90°. This flange will be on the outside of the box.
6. Fold the box into a square and then fold the locking seam, first folding the outer tab **C2** tightly over flange **D**, then folding along line **c-c**
7. Lay in 2 corner pieces and then finish folding one flange **B** pressing it to lock the corner pieces in place. Work around the rim inserting corners, folding the remaining **B** flanges.

### Corner Pieces

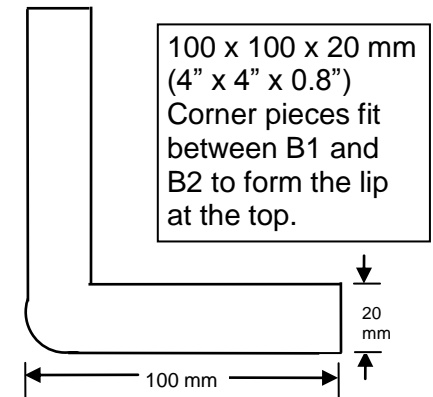

# Figure 5

## Folding Detail for Side Wall Piece

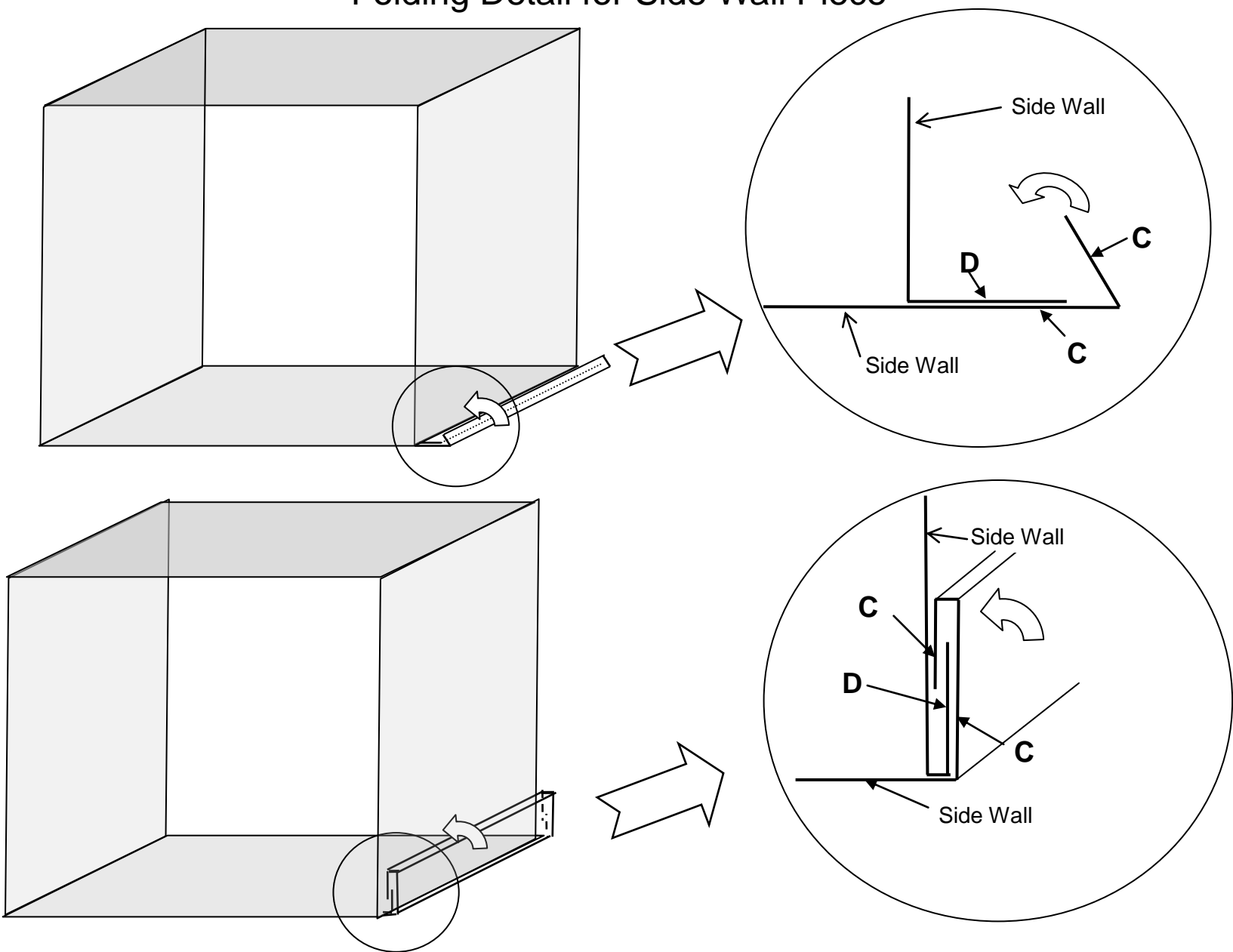

# Figure 6

## Bottom Piece

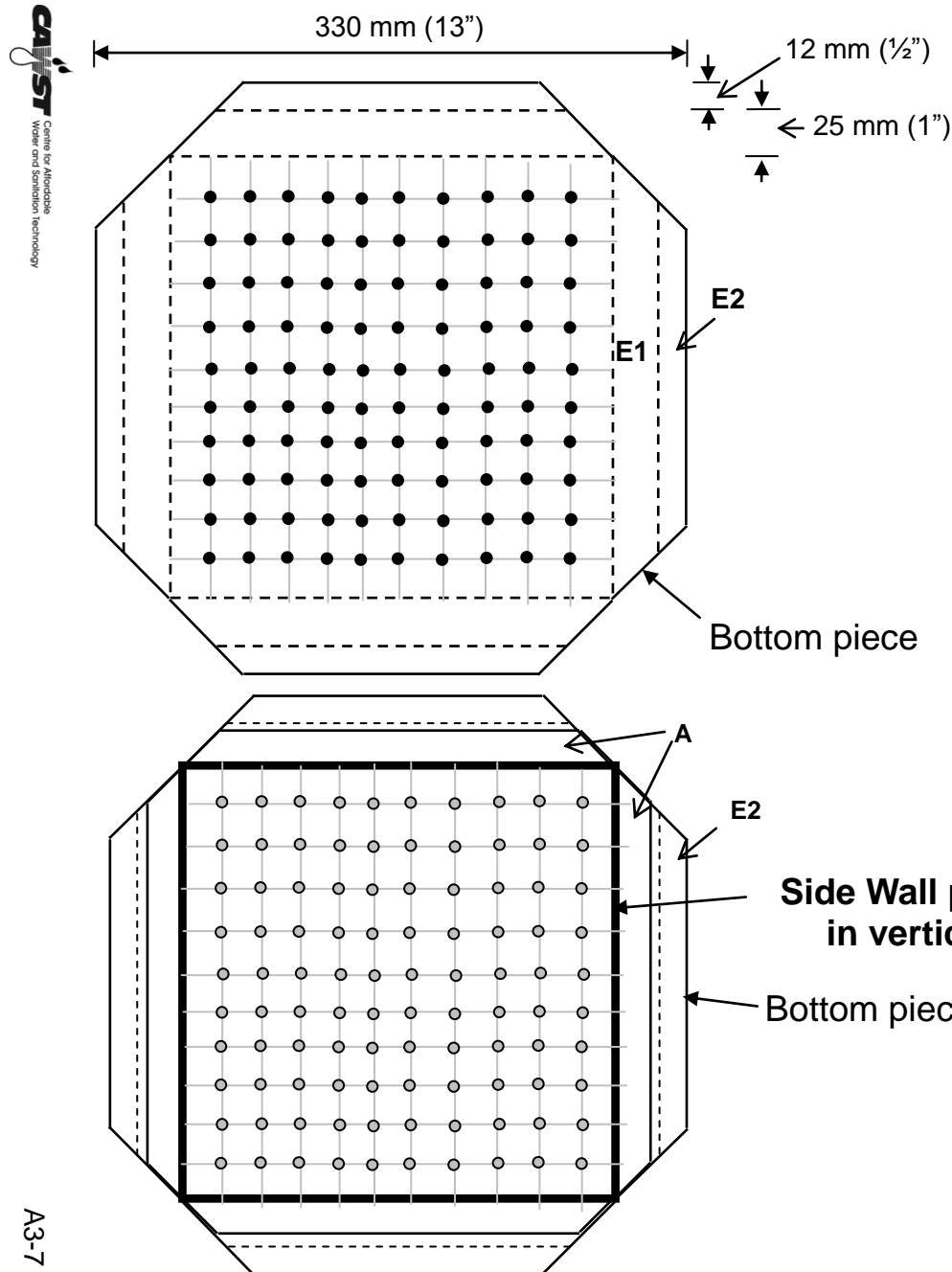

### Folding Sequence for Bottom Piece

1. Punch or drill holes in the Bottom Piece
  - holes to be 3 mm ( $\frac{1}{8}$ " ) in diameter
  - space holes 2.5 cm (1" ) apart
  - make 80 to 100 holes
2. Fold E2 (outer tab of flange E) to 90°
3. Set the box (bold outline below) on the base and fold flanges E2 tightly over flanges A on the bottom sides of the box.
4. Fold up flange E against the outside of the box.

See also Figure 7 – Folding Detail for Bottom Piece

# Figure 7

## Folding Detail for Bottom Piece

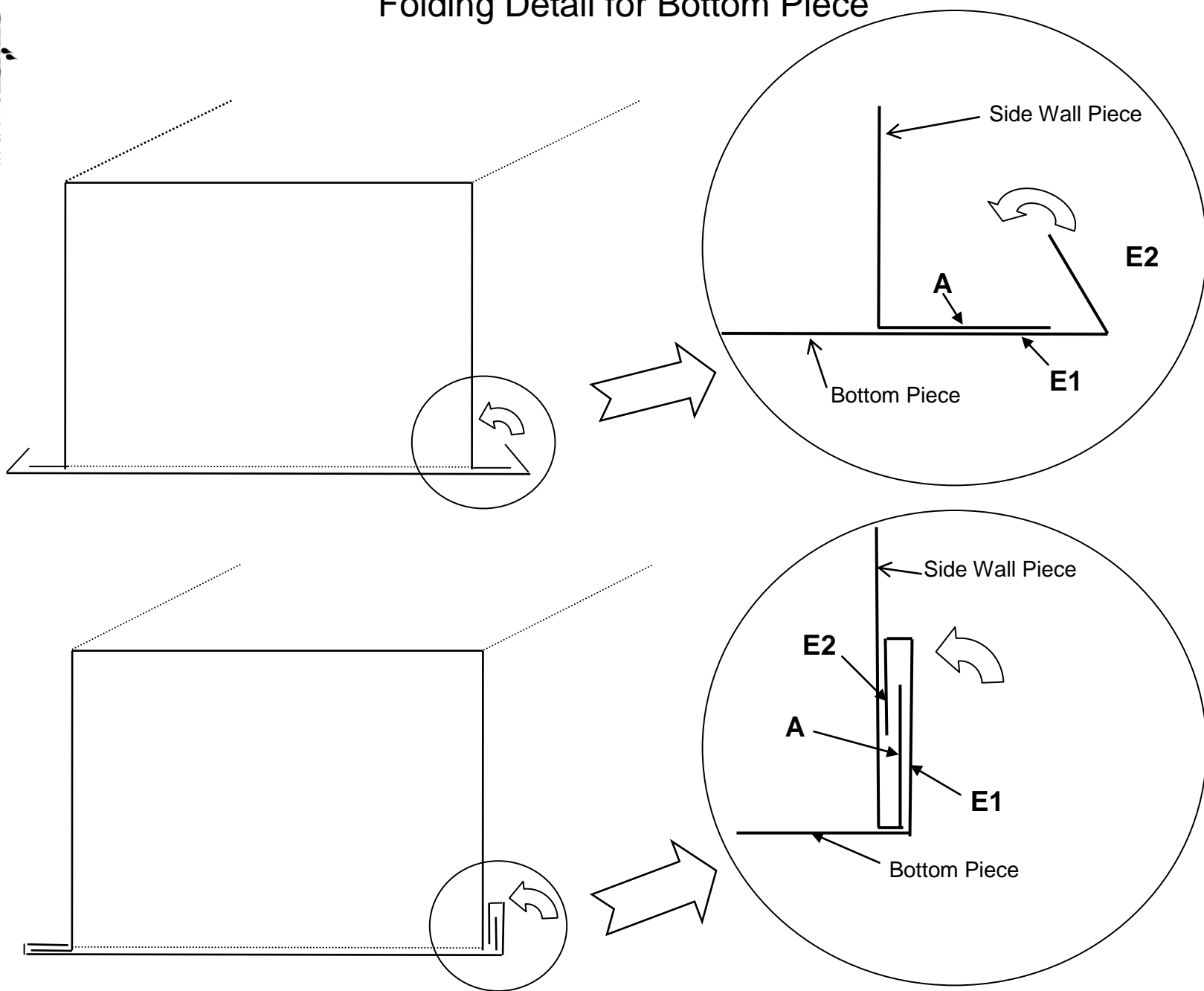

## Option 2 – Tapered Metal Diffuser Box and Lid

### Tools:

- Long straight edge or ruler (120 cm/48" or longer)
- Tape measure
- Square or right angle
- Marker
- Metal cutters suitable for 28 gauge galvanized sheet metal
- Drill with 3 mm (1/8") drill bit
- Hammer
- Folding tool (e.g. bending brake)
- Anvil or steel plate set in a vice to hammer sheet metal against

### Materials:

- Galvanized sheet metal, 28 gauge thick (0.46 mm or 0.018")
  - 1 piece 336 mm x 336 mm (13 x 13 1/4")
  - 1 piece 274 mm x 274 mm (10 3/4" x 10 3/4")
  - 1 piece 975 mm x 201 mm (38 3/8" x 7 7/8") OR 2 pieces 501 mm x 201 mm (19.7" x 7 7/8")

Please contact CAWST for construction designs for the tapered diffuser basin (available in metric and imperial units).

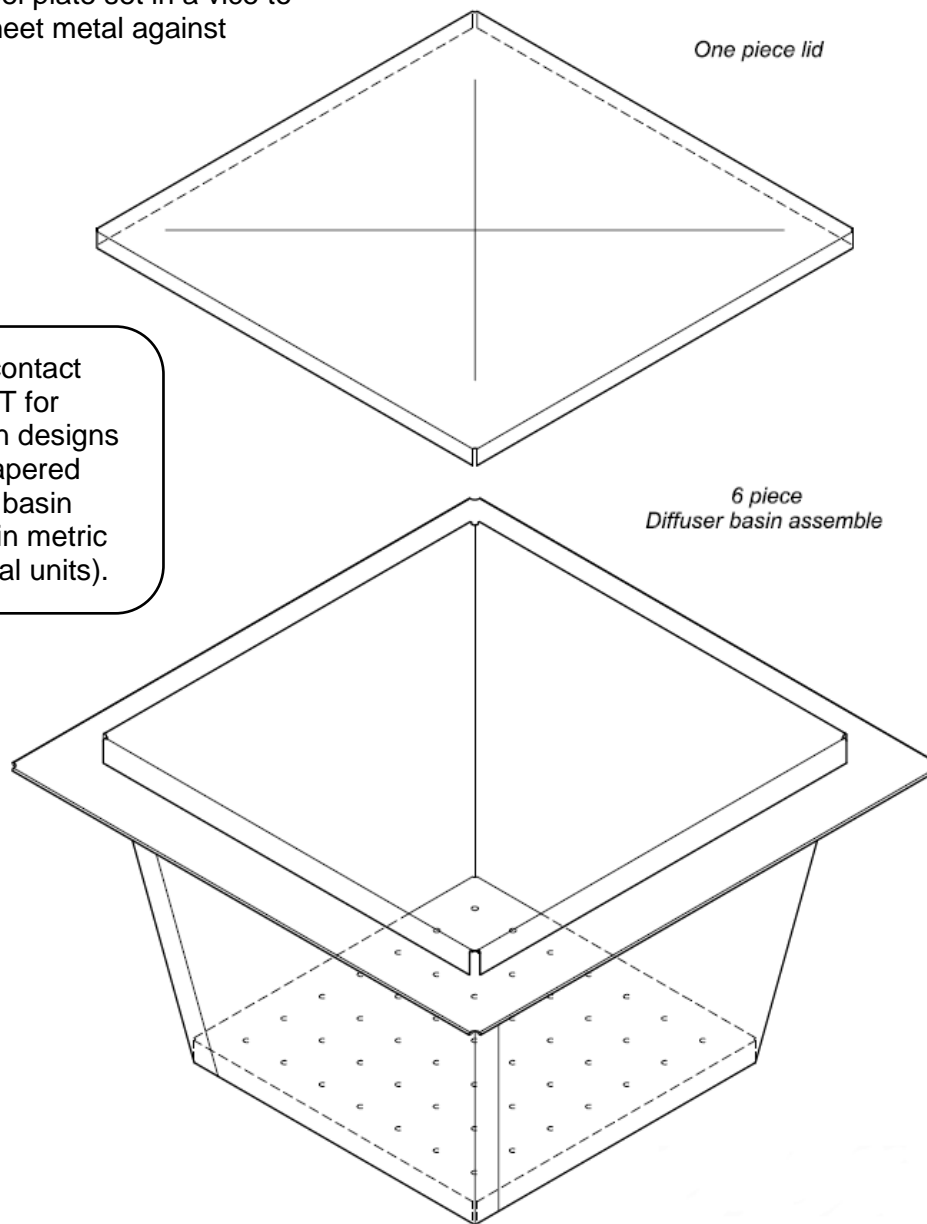

## Option 3 – Metal Diffuser Plate

### Tools:

- Tape measure
- Tin snips
- Leather gloves
- Hammer
- Marker
- 3 mm (1/8") diameter nails

### Materials:

- 30 gauge [0.4 mm (0.0157") thick] galvanized sheet metal (or nearest available size)

### Steps:

1. Measure the inside reservoir of the filter at the height of the ledge where the diffuser will sit. If the filter is not perfectly square, you may need to measure the width in both directions.
2. Cut a piece of sheet metal that is 10 cm (4") wider than the reservoir (in both directions).
3. Measure and mark a square 5 cm (2") from the edge of each side. This square should be the size of the ledge where the diffuser will sit.
4. Measure and mark a 2.5 cm x 2.5 cm (1" x 1") grid on the sheet metal, inside the square from Step 3.
5. At each intersection on the grid, pound a 3 mm (1/8") diameter hole through the sheet metal, including around the outside edge of the grid. Use a hammer and a 3 mm (1/8") diameter nail to make the holes.

**Tip:** A jig can be constructed out of wood with nail tips in a 2.5 cm x 2.5 cm (1"x1") grid, facing up out of the wood so that the sheet metal can be pounded onto the jig, forming all of the holes in one step.

6. Fold the sides of the sheet up along the outside square line from Step 3. You may want to fold each side over twice to prevent sharp edges. You will have to fold the corners or cut diagonally into each corner.
7. Make a handle so that the diffuser can be easily pulled out, once in place. Handles can be made from a piece of nylon string or wire tied through holes in the diffuser plate, or a bent nail.



Drawing a grid will help with the nail-hole placement



Holes should be 3mm diameter, 2.5 cm (1") apart.

## Option 4 – Acrylic/Plastic Diffuser Plate

### Tools:

- Tape measure
- Electric saw or acrylic cutting knife
- Electric drill
- Marker
- 3 mm (1/8") diameter nails

### Materials:

- Clear acrylic plastic or stiff polyethylene plastic
- Nylon string or nail

### Steps:

1. Measure the inside of the reservoir at the height of the ledge where the diffuser will sit. If the filter is not perfectly square, you may need to measure the width in both directions.
2. With a saw or using an acrylic cutting knife, cut a piece of plastic the same size as the reservoir.
3. Measure and mark a 2.5 cm x 2.5 cm (1" x 1") grid on the plastic.
4. At each intersection on the grid, drill a 3 mm (1/8") diameter hole through the plastic.
5. Make a handle so that the diffuser can be easily pulled out, once in place. Handles can be made from a piece of nylon string or wire tied through holes in the diffuser plate, or a bent nail.

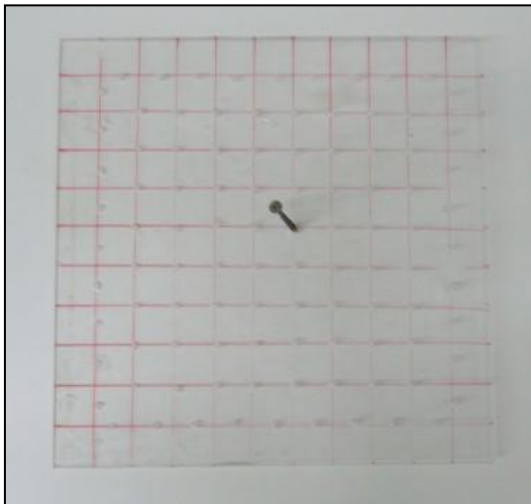

An acrylic plastic diffuser with a grid of holes spaced 2.5 cm (1") apart

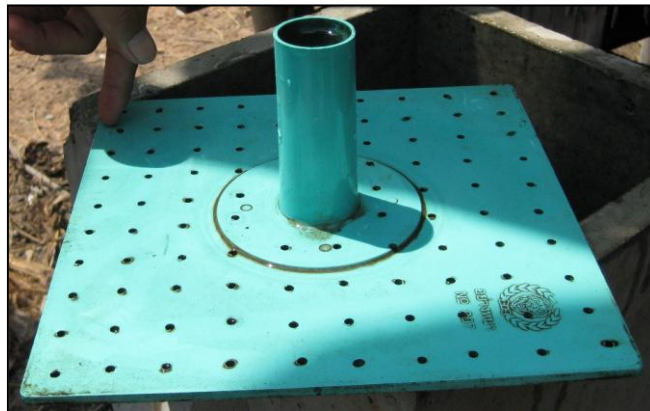

A diffuser made from a commercially available plastic paint float, with 3mm holes spaced 2.5 cm (1") apart

## Option 5 – Wooden Lid

### Tools:

- Hammer
- Tape measure
- Saw
- Paint brush

### Materials:

- 2.5 cm x 10 cm (1" x 4") lumber (or whatever is locally available)
- Nails or screws
- Oil paint

### Steps:

1. Measure the outside width of the concrete filter at the top. If the filter is not perfectly square, you may need to measure the width in both directions.
2. Cut pieces of wood sufficient to cover the entire top of the filter. These pieces will form the lid itself.
3. Place these pieces in the shape of the lid, with the underside facing up.
4. Measure the top inside of the filter reservoir. If the filter is not perfectly square, you may need to measure the width in both directions.
5. Mark the size and position of the opening on the pieces of your lid (from Step 3). Cut two pieces of wood the length of the opening of the filter.
6. Place those two pieces of wood perpendicular to the other pieces, on top of the others.
7. Centre those two pieces of wood so that in both directions, they line up with the opening of the filter that you marked in Step 5. (Those two pieces will sit inside the opening on the filter and will stop the lid from moving in either direction.)
8. Nail each of the two pieces onto all of the other pieces.
9. Flip your lid over and ensure that it fits on the filter. (The two pieces from Step 6 should just fit inside the filter, and the other pieces should cover the entire top edge of the filter.)
10. Attach a handle. This handle is optional as the top of the filter can be used as storage if the handle is not attached (see photo below). If no handle is attached, the filter lid will still be easy to remove.
11. Paint the lid with oil paint to prevent mold from growing on the inside of the lid.



Wooden lid with a knob handle



Wooden lid with block handle

**Tip:** Nails straight through the lid into the handle don't hold the handle on very well.  
Use at least two nails at different angles or a screw.



## Appendix 4 – The Cost of a Biosand Filter

|  |      |
|--|------|
| 1. Calculating the cost of construction and installation ..... | A4-1 |
| 2. Calculating the cost of transportation .....                | A4-2 |
| 3. Calculating the cost of user education.....                 | A4-2 |
| 4. Calculating the cost of follow-up.....                      | A4-3 |
| 5. Calculating the total cost of a biosand filter .....        | A4-4 |



## 1. Calculating the cost of construction and installation

| <b>Calculating the Cost of a Biosand Filter</b> |                 |              |                  |                 |                     |
|---|-----------------|--------------|------------------|-----------------|---------------------|
| <b>CONSTRUCTION &amp; INSTALLATION</b>          | <b>Quantity</b> | <b>Unit</b>  | <b>Price</b>     | <b>Per Unit</b> | <b>Cost</b>         |
| <b>For 1 Filter:</b>                            | (e.g. 3)        | (e.g. litre) | (e.g. per litre) | (e.g. litre)    | (=quantity X price) |
| <b>MATERIALS</b>                                |                 |              |                  |                 |                     |
| <b>Concrete Container</b>                       |                 |              |                  |                 |                     |
| Cement  |                 | bag          |                  | bag             |                     |
| Sand  |                 | L            |                  | L               |                     |
| Small gravel                                    |                 | L            |                  | L               |                     |
| Large gravel                                    |                 | L            |                  | L               |                     |
| Tubing (3')                                     |                 | m            |                  | m               |                     |
| Tape for securing tubing etc.                   |                 | m            |                  | m               |                     |
| Edible oil, margarine or lard                   |                 | mL           |                  | mL              |                     |
| <b>Finishing the container</b>                  |                 |              |                  |                 |                     |
| Soap  |                 | mL           |                  | mL              |                     |
| Paint   |                 | can          |                  | can             |                     |
| <b>Diffuser</b>                                 |                 |              |                  |                 |                     |
| Sheet metal                                     |                 | square m     |                  | square m        |                     |
| <b>Lid</b>                                      |                 |              |                  |                 |                     |
| Wood or sheet metal                             |                 | m            |                  | m               |                     |
| <b>Inside the filter</b>                        |                 |              |                  |                 |                     |
| Sand  |                 | L            |                  | L               |                     |
| Separation gravel                               |                 | L            |                  | L               |                     |
| Drainage gravel                                 |                 | L            |                  | L               |                     |
| Sacks or bags                                   |                 | bag          |                  | bag             |                     |
| <b>Total Materials (Hardcosts)</b>              |                 |              |                  |                 | <b>=</b>            |
| <b>LABOUR</b>                                   |                 |              |                  |                 |                     |
| Labour - making filter                          |                 | hr           |                  | hr              |                     |
| Labour - finishing filter                       |                 | hr           |                  | hr              |                     |
| Labour - making diffuser                        |                 | hr           |                  | hr              |                     |
| Labour - making lid                             |                 | hr           |                  | hr              |                     |
| Labour - sieving                                |                 | hr           |                  | hr              |                     |
| Labour - washing                                |                 | hr           |                  | hr              |                     |
| Labour - other (e.g. crushing rock by hand)     |                 | hr           |                  | hr              |                     |
| Labour - installation                           |                 | hr           |                  | hr              |                     |
| <b>Total Construction Labour Cost</b>           |                 |              |                  |                 | <b>=</b>            |
| <b>TOTAL CONSTRUCTION COST</b>                  |                 |              |                  |                 | <b>=</b>            |

e.g. = for example

## 2. Calculating the cost of transportation

| Calculating the Cost of a Biosand Filter |          |               |                  |              |                     |
|--|----------|---------------|------------------|--------------|---------------------|
| TRANSPORTATION                           |          |               |                  |              |                     |
|  | Quantity | Unit          | Price            | Per Unit     | Cost                |
| <b>For 1 Filter:</b>                     | (e.g. 3) | (e.g. litres) | (e.g. per litre) | (e.g. litre) | (=quantity X price) |
| <b>TRANSPORT</b>                         |          |               |                  |              |                     |
| Vehicle rental or ownership              |          | days          |                  | day          |                     |
| Fuel                                     |          | tank          |                  | tank         |                     |
| Other costs (tolls, taxes, maintenance)  |          |               |                  |              |                     |
|  |          |               |                  |              |                     |
|  |          |               |                  |              |                     |
| Total Transportation Hard Costs          |          |               |                  |              | =                   |
| <b>LABOUR</b>                            |          |               |                  |              |                     |
| Staff time - loading filters             |          | hr            |                  | hr           |                     |
| Staff time - transportation/driving      |          | hr            |                  | hr           |                     |
|  |          |               |                  |              |                     |
| Total Transportation Labour Cost         |          |               |                  |              | =                   |
| <b>TOTAL TRANSPORTATION COST</b>         |          |               |                  |              | =                   |

## 3. Calculating the cost of user education

| Calculating the Cost of a Biosand Filter                     |          |               |                  |              |                     |
|--|----------|---------------|------------------|--------------|---------------------|
| USER EDUCATION   |          |               |                  |              |                     |
|  | Quantity | Unit          | Price            | Per Unit     | Cost                |
| <b>For 1 Filter:</b>   | (e.g. 3) | (e.g. litres) | (e.g. per litre) | (e.g. litre) | (=quantity X price) |
| <b>EDUCATION DURING INSTALLATION</b>                         |          |               |                  |              |                     |
| <b>Hard Costs</b>  |          |               |                  |              |                     |
| Vehicle rental or ownership                                  |          | days          |                  | day          |                     |
| Fuel   |          | tank          |                  | tank         |                     |
| Education materials for the user (pamphlet, sticker, poster) |          |               |                  |              |                     |
| Other costs (tolls, taxes, maintenance)                      |          |               |                  |              |                     |
|  |          |               |                  |              |                     |
| Total Education Hard Costs                                   |          |               |                  |              | =                   |
| <b>Labour</b>  |          |               |                  |              |                     |
| Staff time - educating users                                 |          | hr            |                  | hr           |                     |
|  |          |               |                  |              |                     |
| Total Education Labour Cost                                  |          |               |                  |              | =                   |
| <b>TOTAL EDUCATION COST</b>                                  |          |               |                  |              | =                   |

e.g. = for example

## 4. Calculating the cost of follow-up

| Calculating the Cost of a Biosand Filter |          |               |                  |              |                     |
|--|----------|---------------|------------------|--------------|---------------------|
| FOLLOW-UP                                | Quantity | Unit          | Price            | Per Unit     | Cost                |
| <b>For 1 Filter:</b>                     | (e.g. 3) | (e.g. litres) | (e.g. per litre) | (e.g. litre) | (=quantity X price) |
| <b>VISIT 1 - Hard Costs</b>              |          |               |                  |              |                     |
| Vehicle rental or ownership              |          | days          |                  | day          |                     |
| Fuel                                     |          | tank          |                  | tank         |                     |
| Other costs (tolls, taxes, maintenance)  |          |               |                  |              |                     |
| Education materials - printing           |          |               |                  |              |                     |
| Total Visit 1 Hard Costs                 |          |               |                  |              | =                   |
| <b>Labour</b>                            |          |               |                  |              |                     |
| Staff time - transportation/driving      |          | hr            |                  | hr           |                     |
| Staff time - follow-up visit             |          | hr            |                  | hr           |                     |
| Total Visit 1 Labour Cost                |          |               |                  |              | =                   |
| Total Visit 1 Cost                       |          |               |                  |              | =                   |
| <b>VISIT 2 - Hard Costs</b>              |          |               |                  |              |                     |
| Vehicle rental or ownership              |          | days          |                  | day          |                     |
| Fuel                                     |          | tank          |                  | tank         |                     |
| Other costs (tolls, taxes, maintenance)  |          |               |                  |              |                     |
| Education materials - printing           |          |               |                  |              |                     |
| Total Visit 2 Hard Costs                 |          |               |                  |              | =                   |
| <b>Labour</b>                            |          |               |                  |              |                     |
| Staff time - transportation/driving      |          | hr            |                  | hr           |                     |
| Staff time - follow-up visit             |          | hr            |                  | hr           |                     |
| Total Visit 2 Labour Cost                |          |               |                  |              | =                   |
| Total Visit 2 Cost                       |          |               |                  |              | =                   |
| <b>VISIT 3 - Hard Costs</b>              |          |               |                  |              |                     |
| Vehicle rental or ownership              |          | days          |                  | day          |                     |
| Fuel                                     |          | tank          |                  | tank         |                     |
| Other costs (tolls, taxes, maintenance)  |          |               |                  |              |                     |
| Education materials - printing           |          |               |                  |              |                     |
| Total Visit 3 Hard Costs                 |          |               |                  |              | =                   |
| <b>Labour</b>                            |          |               |                  |              |                     |
| Staff time - transportation/driving      |          | hr            |                  | hr           |                     |
| Staff time - follow-up visit             |          | hr            |                  | hr           |                     |
| Total Visit 3 Labour Cost                |          |               |                  |              | =                   |
| Total Visit 3 Cost                       |          |               |                  |              | =                   |
| <b>TOTAL FOLLOW-UP COST (3 Visits)</b>   |          |               |                  |              | =                   |

e.g. = for example

## 5. Calculating the total cost of a biosand filter

| <b>Calculating the Cost of a Biosand Filter</b> |             |
|---|-------------|
| TOTAL COST of a BIOSAND FILTER                  |             |
|   | <b>Cost</b> |
| <b>For 1 Filter:</b>                            |             |
| <b>CONSTRUCTION &amp; INSTALLATION</b>          |             |
| Hard Costs                                      | =           |
| Labour  | =           |
| Sub-Total                                       | =           |
| <b>TRANSPORTATION</b>                           |             |
| Hard Costs                                      | =           |
| Labour  | =           |
| Sub-Total                                       | =           |
| <b>EDUCATION</b>                                |             |
| Hard Costs                                      | =           |
| Labour  | =           |
| Sub-Total                                       | =           |
| <b>FOLLOW-UP (3 Visits)</b>                     |             |
| Hard Costs                                      | =           |
| Labour  | =           |
| Sub-Total                                       | =           |
|   |             |
| <b>Total Cost</b>                               | <b>=</b>    |