

## CARDBOARD CHESS SET

There are 9 A4 pages of patterns for the components of the chess set. These can be printed directly onto 280 gsm A4 card stock, or alternatively on standard 80 gsm A4 copy paper and then glued into any convenient thin cardboard sheets. A readily available source is empty breakfast cereal packets, or similar packaging material.

Two options are available to construct the pieces, with either hexagonal or round cross sections. If the hexagonal style is chosen, it is not necessary to print pages 9 & 10 which hold the round base patterns. The components of the pieces should be carefully cut out with sharp scissors. If the hexagonal style is to be used, the components should be lightly scored with a sharp blade along the fold lines as indicated, but do not score the fold lines if the round style construction is to be used. For both styles the glue tabs should be scored. The parts are then either folded along the score lines ( hexagonal style ) or rolled around a cylindrical object of suitable diameter for round style pieces.

Following the assembly diagrams, the pieces are glued together using a fast drying craft glue ( polyvinyl acetate type is recommended ) and held in position while the glue dries. Note that the Q1 piece consists of two identical pieces glued back to back. For assembly of the knights, use the strips N3 & N4 cut to suitable lengths to follow the outline of the horse heads and join the two sides.

These cardboard chessmen will be more stable and easier to play with if their base sections are filled with plasticine or modelling clay before attaching the upper parts of the assembly. The larger base pieces hold approximately 9 grams of plasticine and the smaller pawn bases hold approximately 6 grams. For the full chess set approximately 250 grams of plasticine is required.

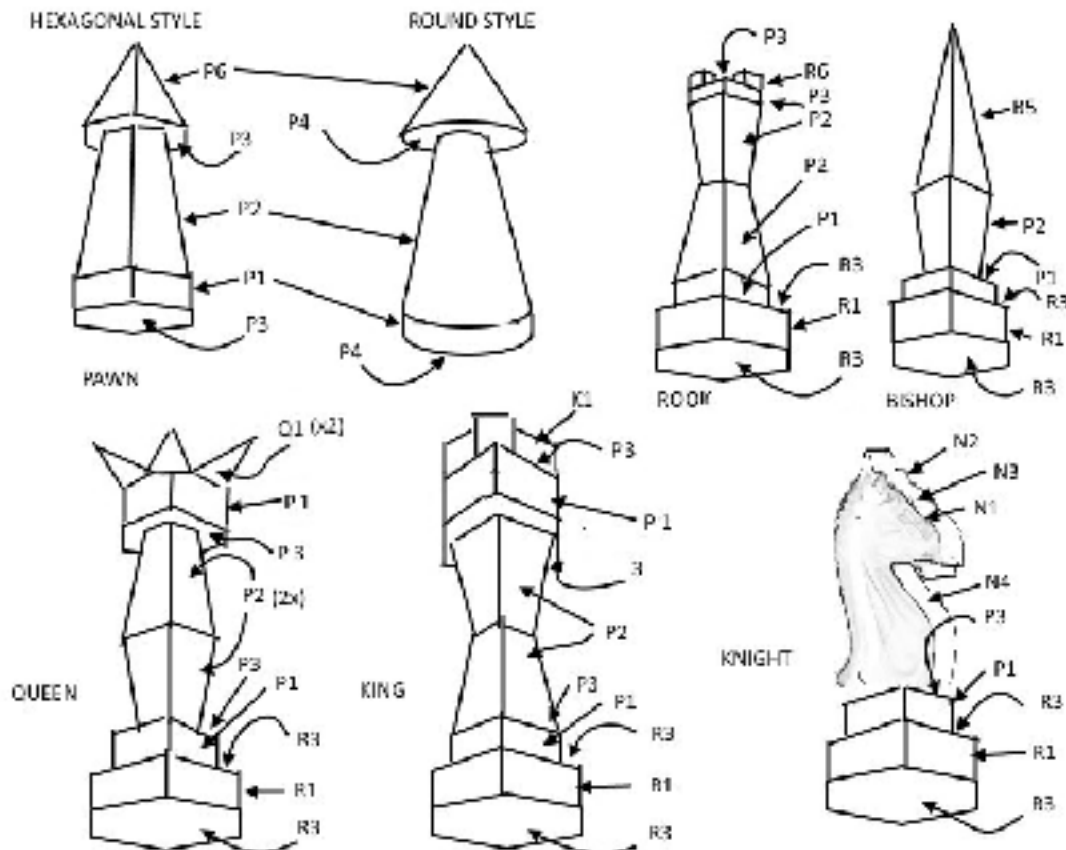

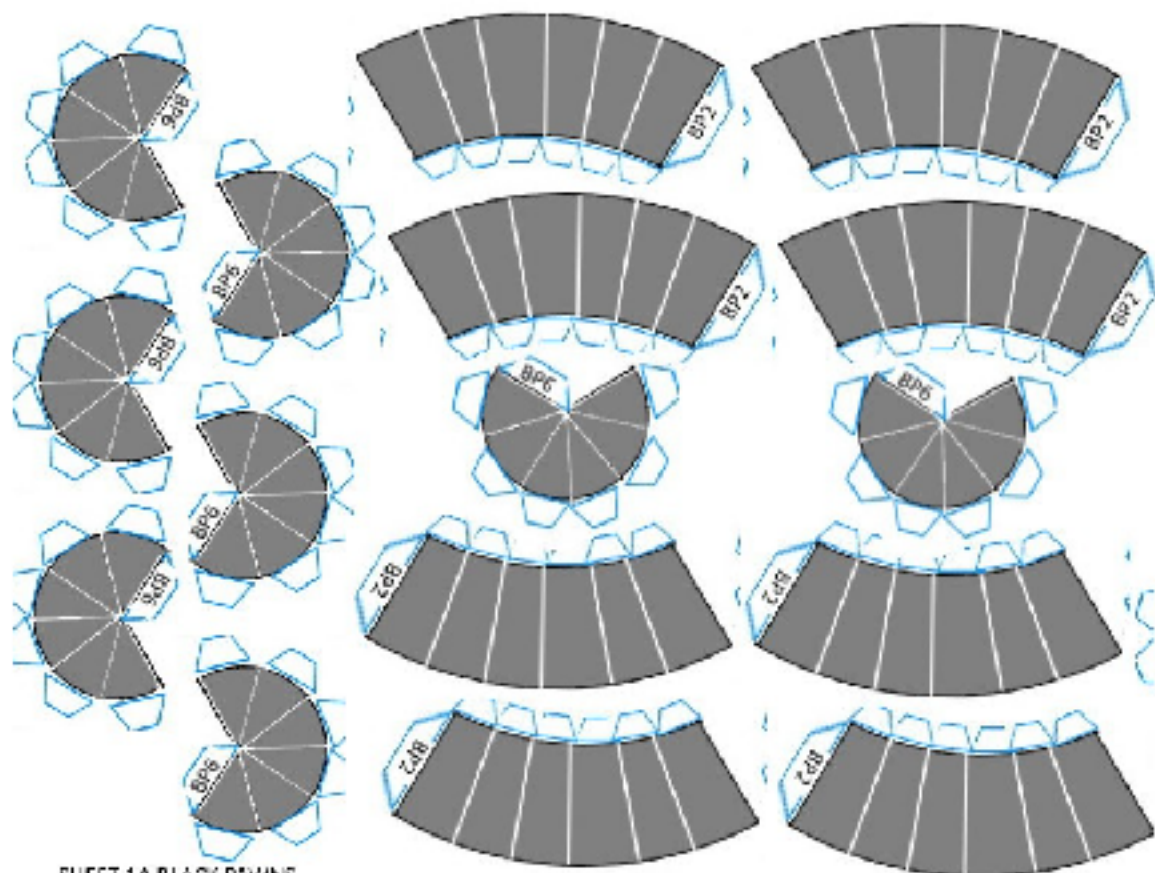
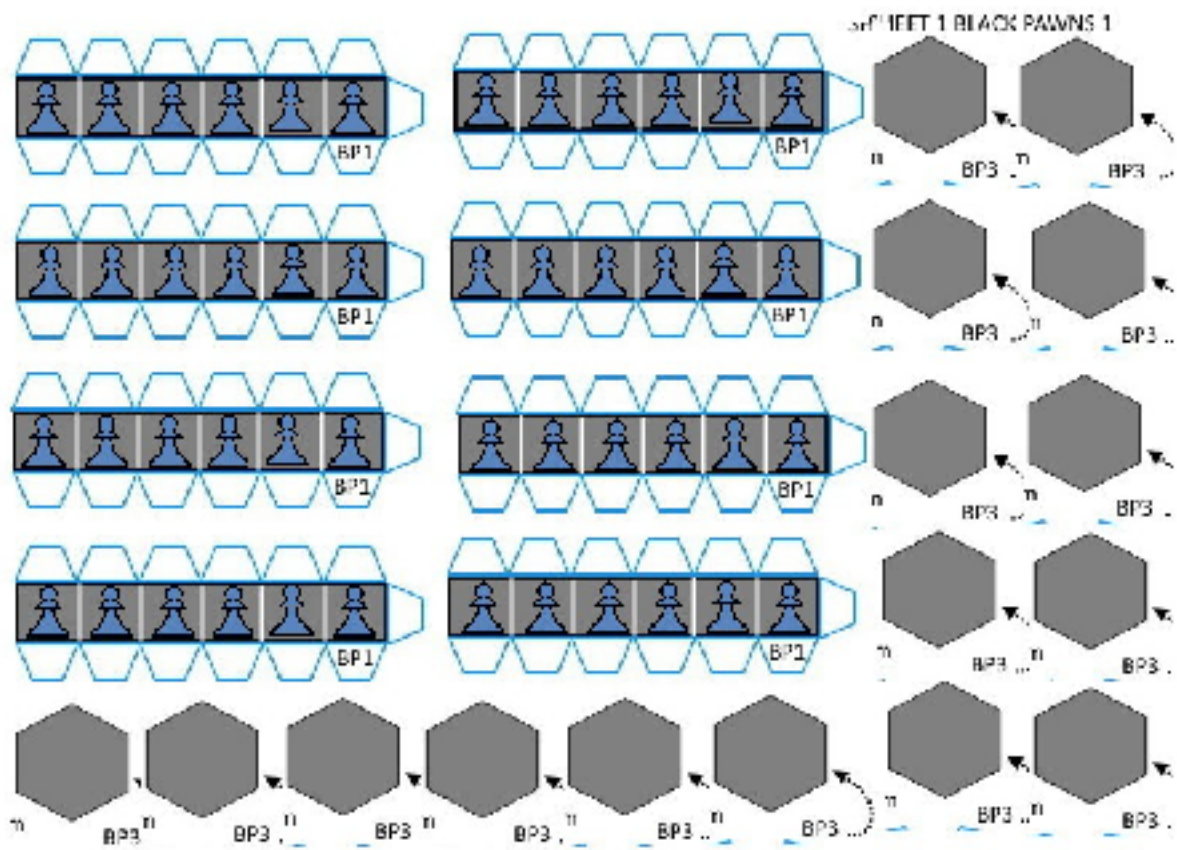

SHEET 1A BLACK PAWNS

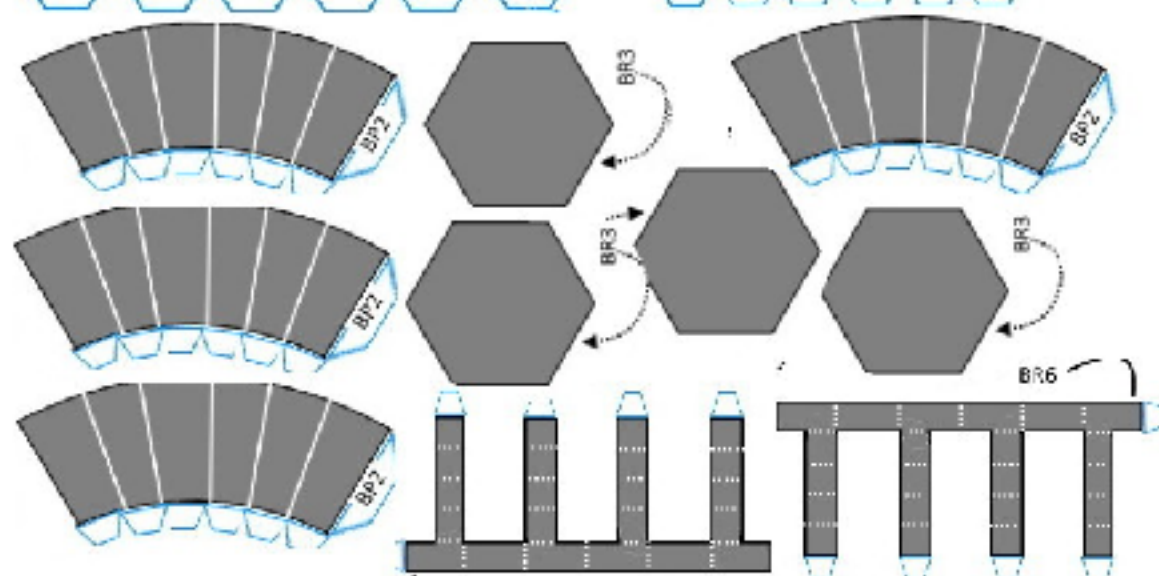
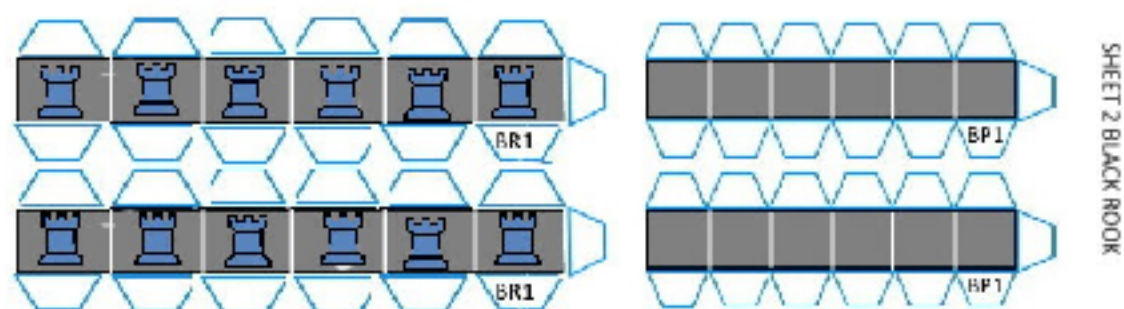
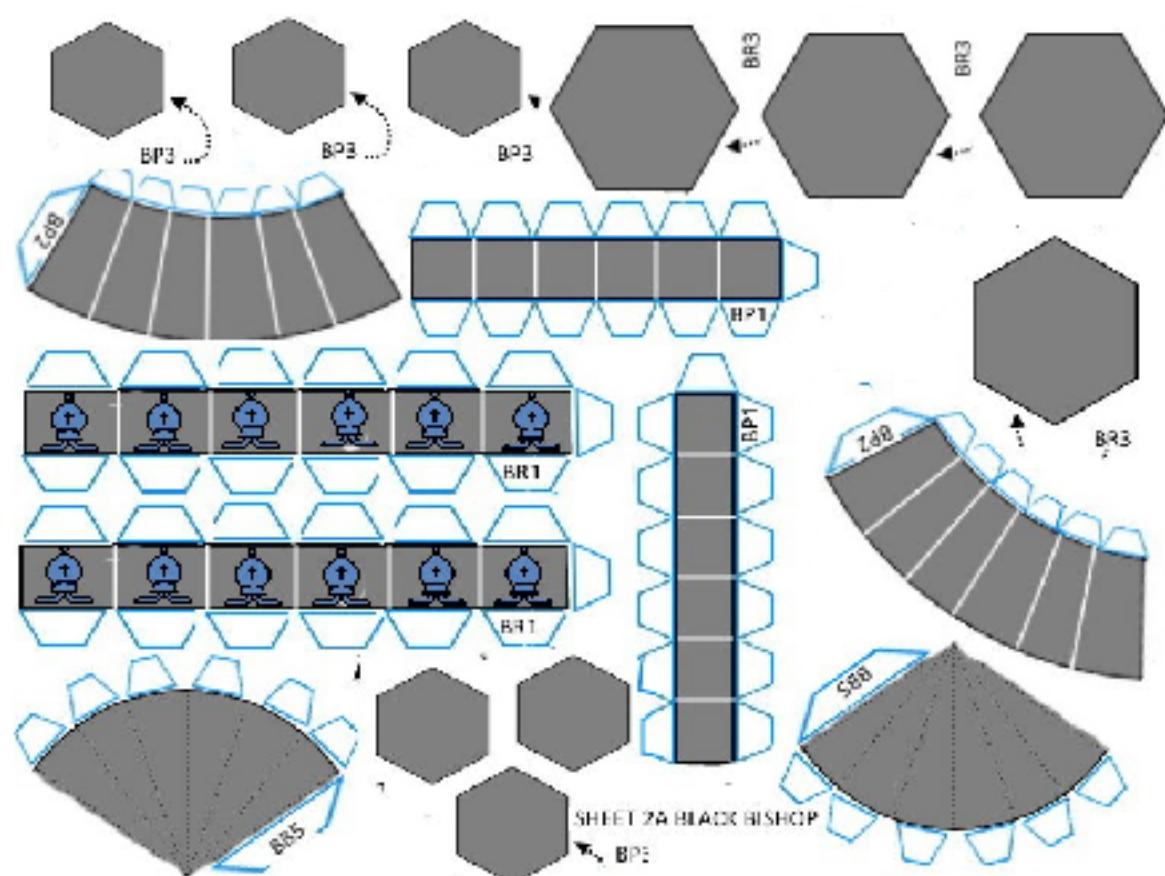

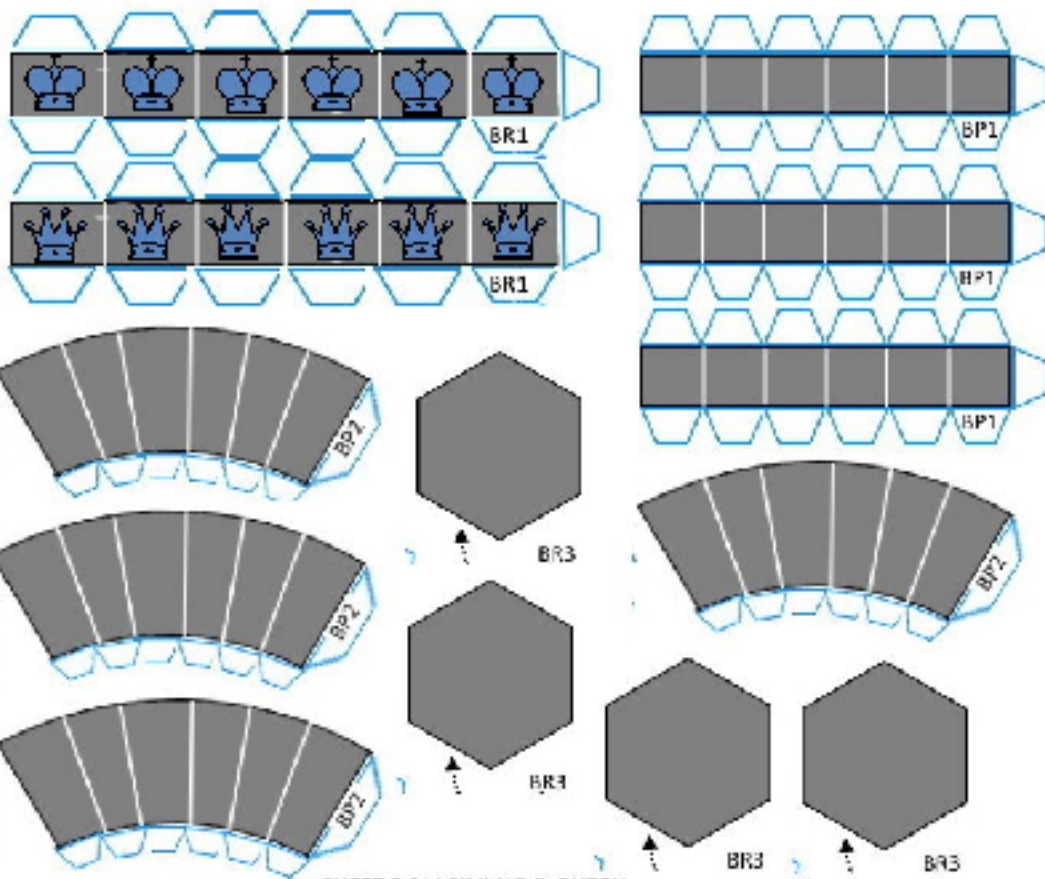

SHEET 3 BLACK KING & QUEEN

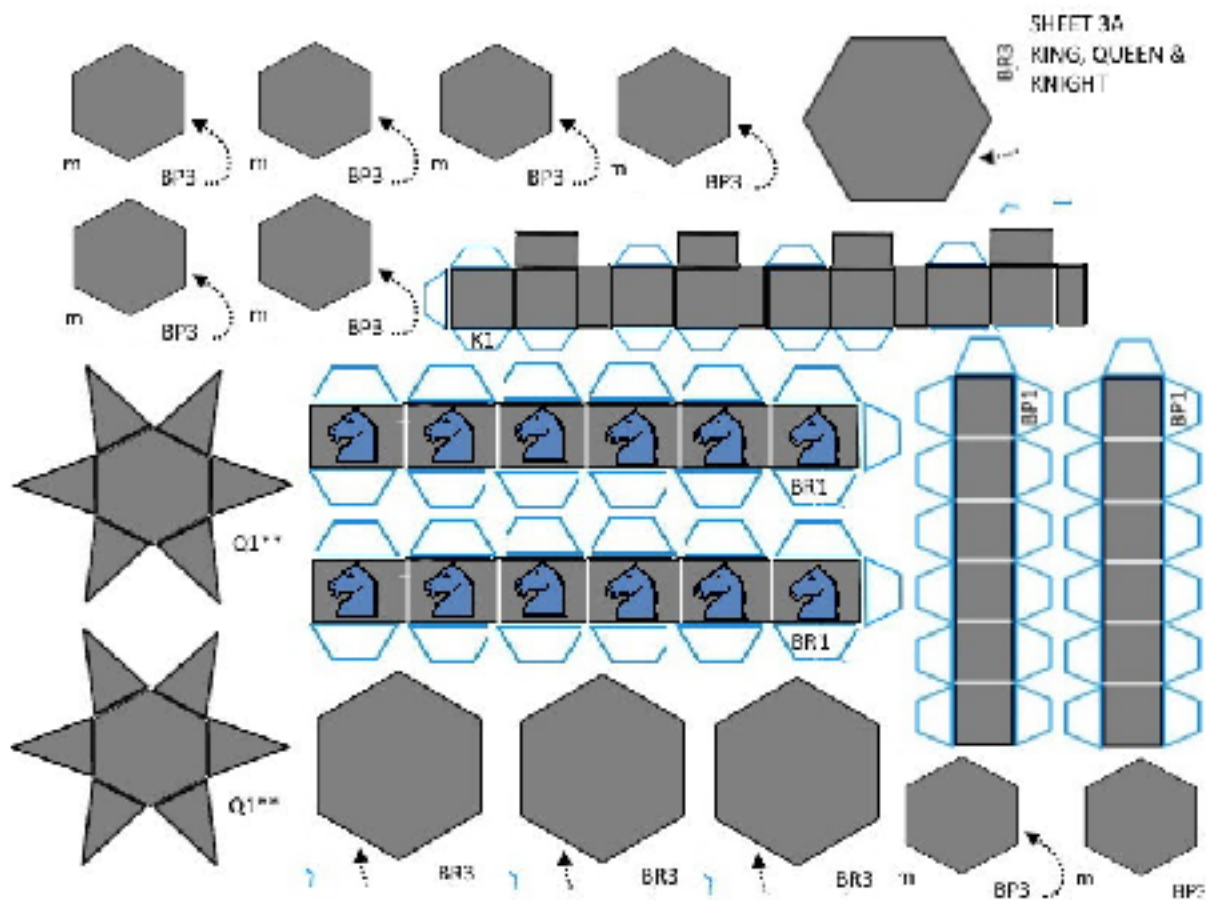

SHEET 3A  
KING, QUEEN &  
KNIGHT

SHEET 4 BLACK KNIGHT

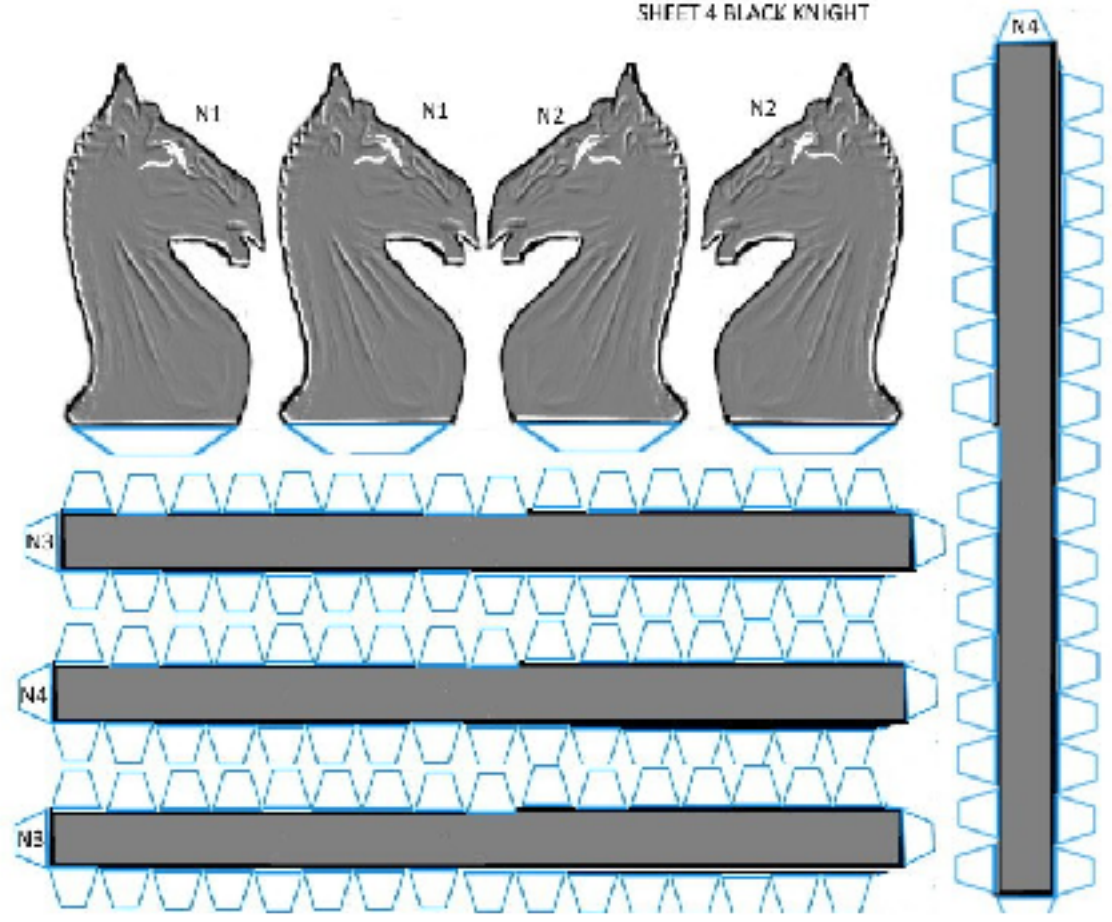

SHEET 4 A WHITE KNIGHT

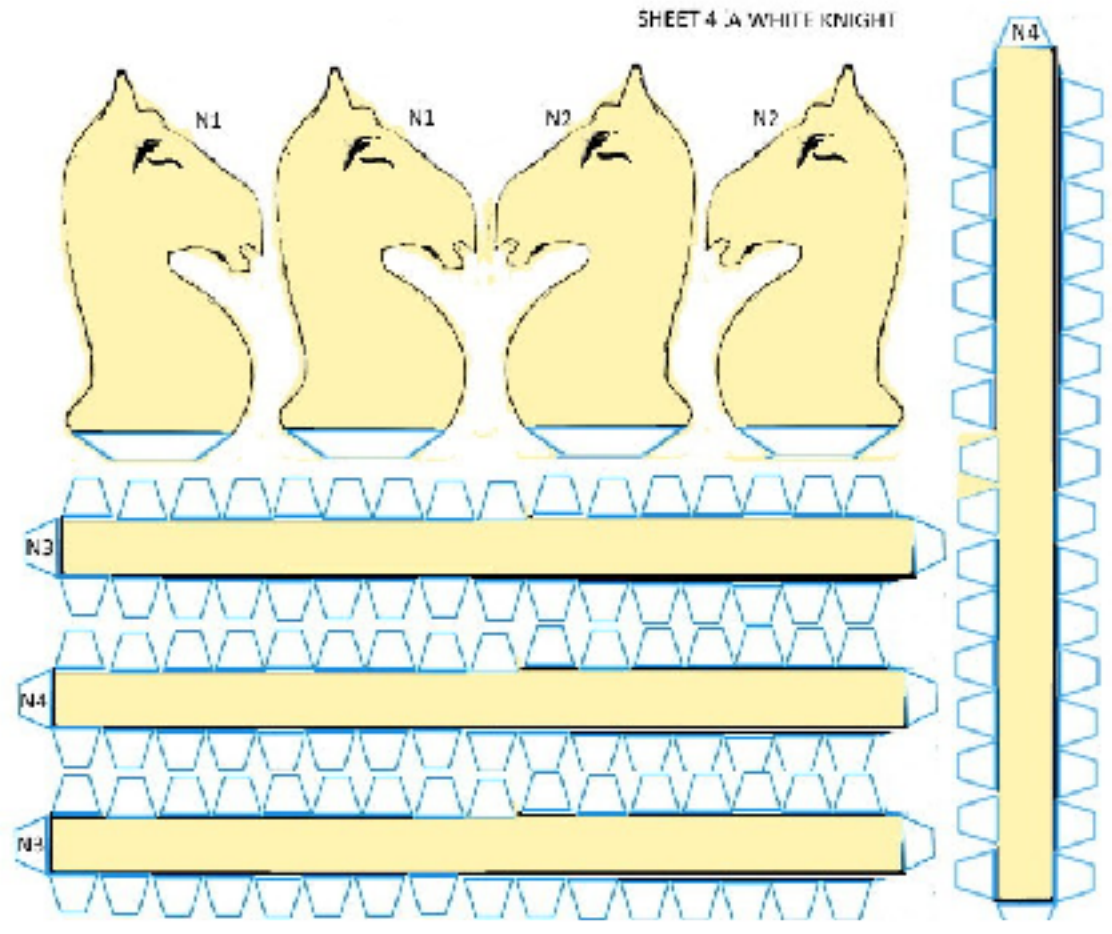

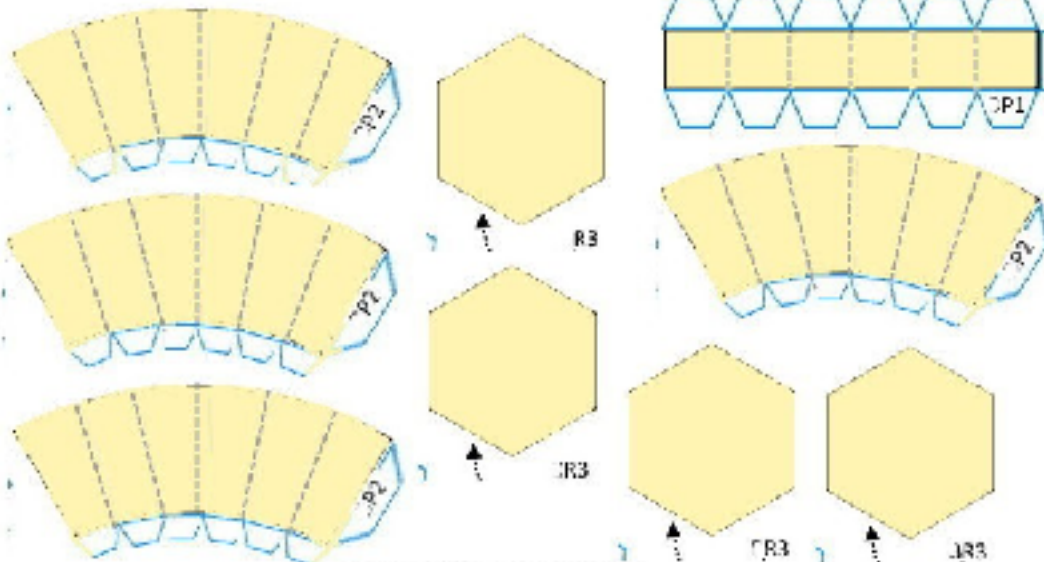
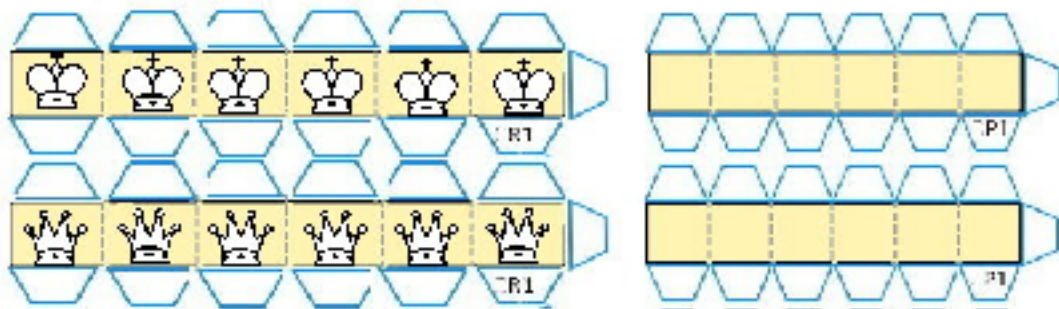

SHEET 5 WHITE KING & QUEEN

SHEET 5A KING, QUEEN & KNIGHT

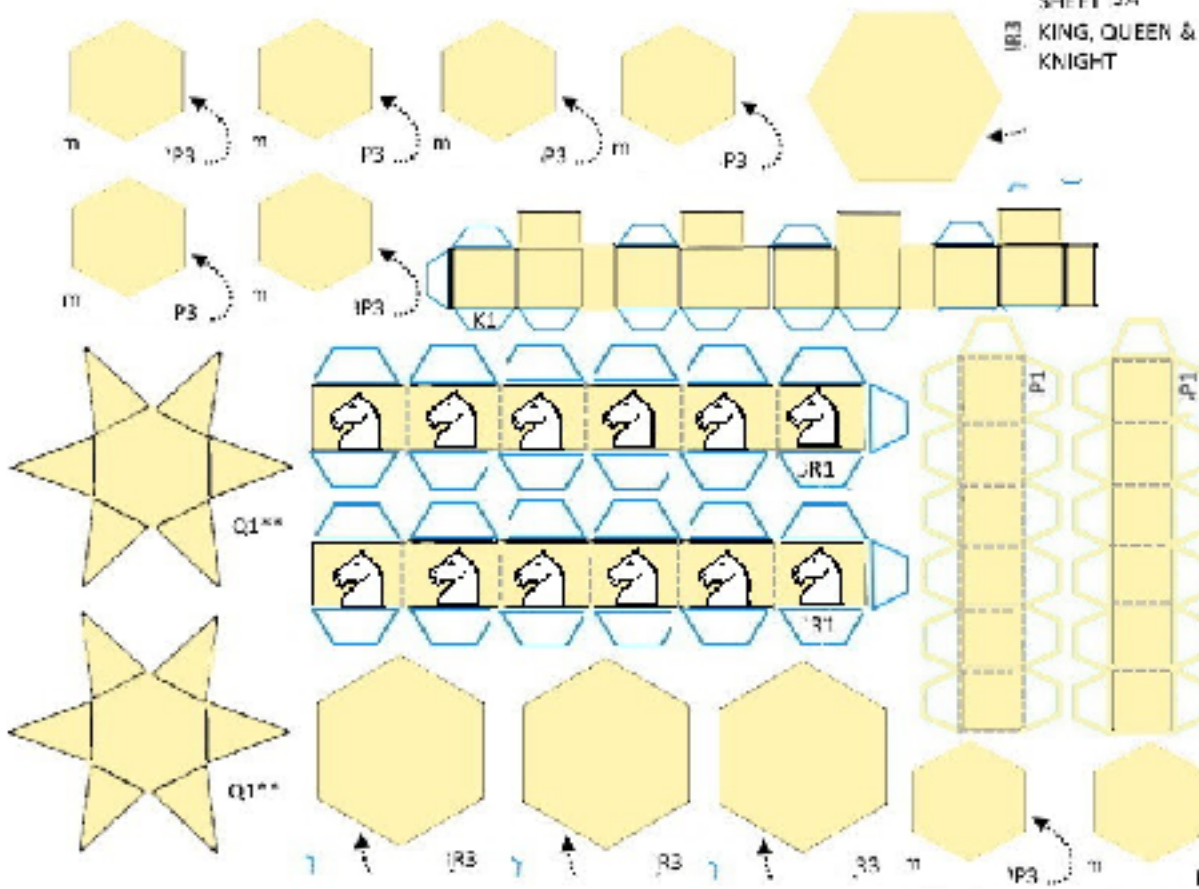

SHEET 5 WHITE ROOK

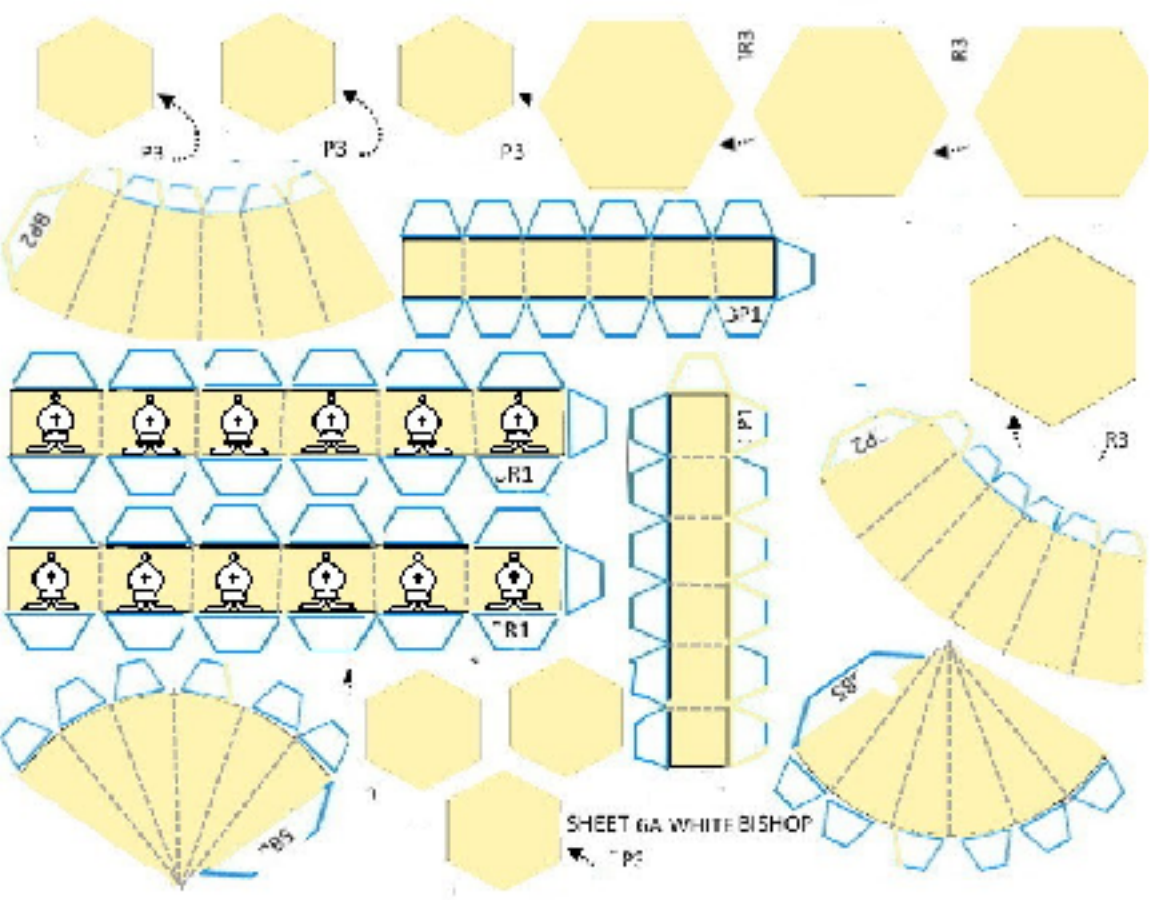
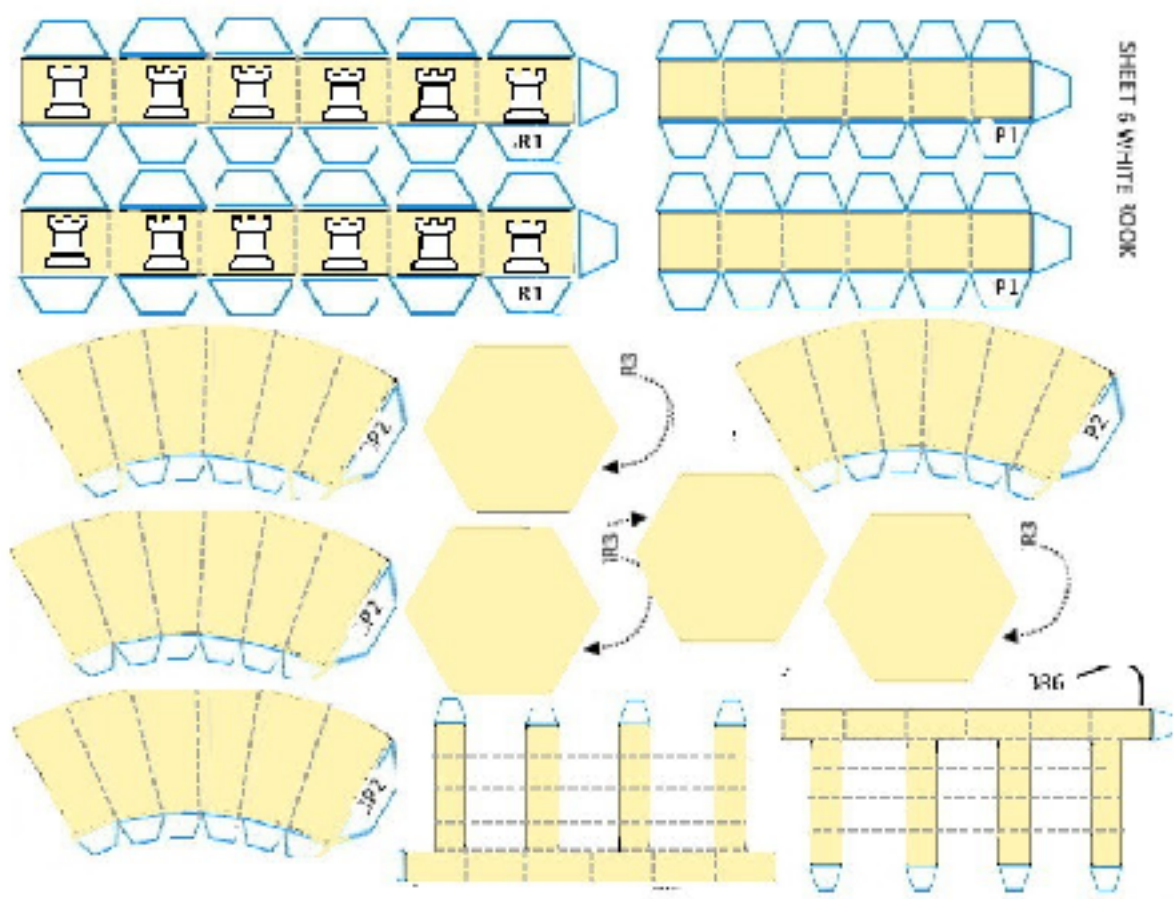

SHEET 6A WHITE BISHOP

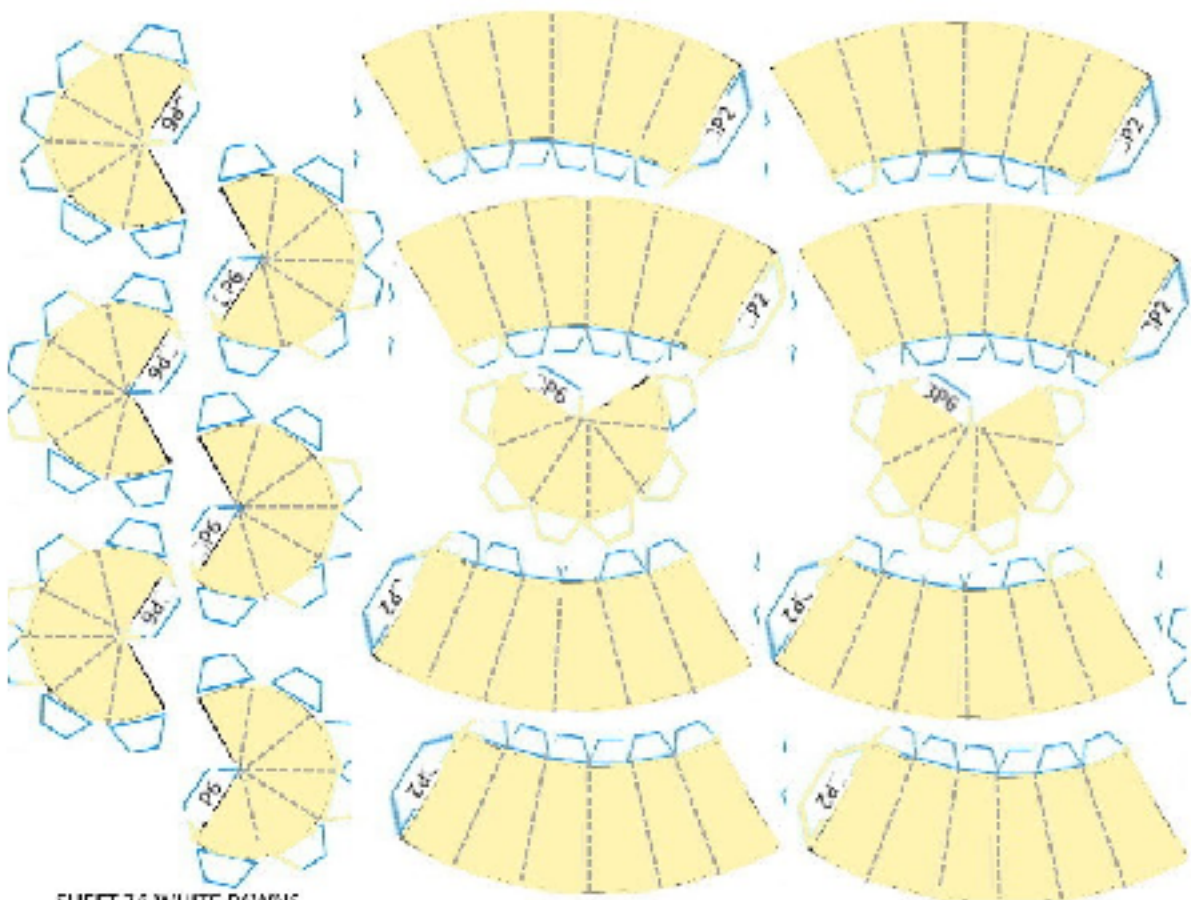
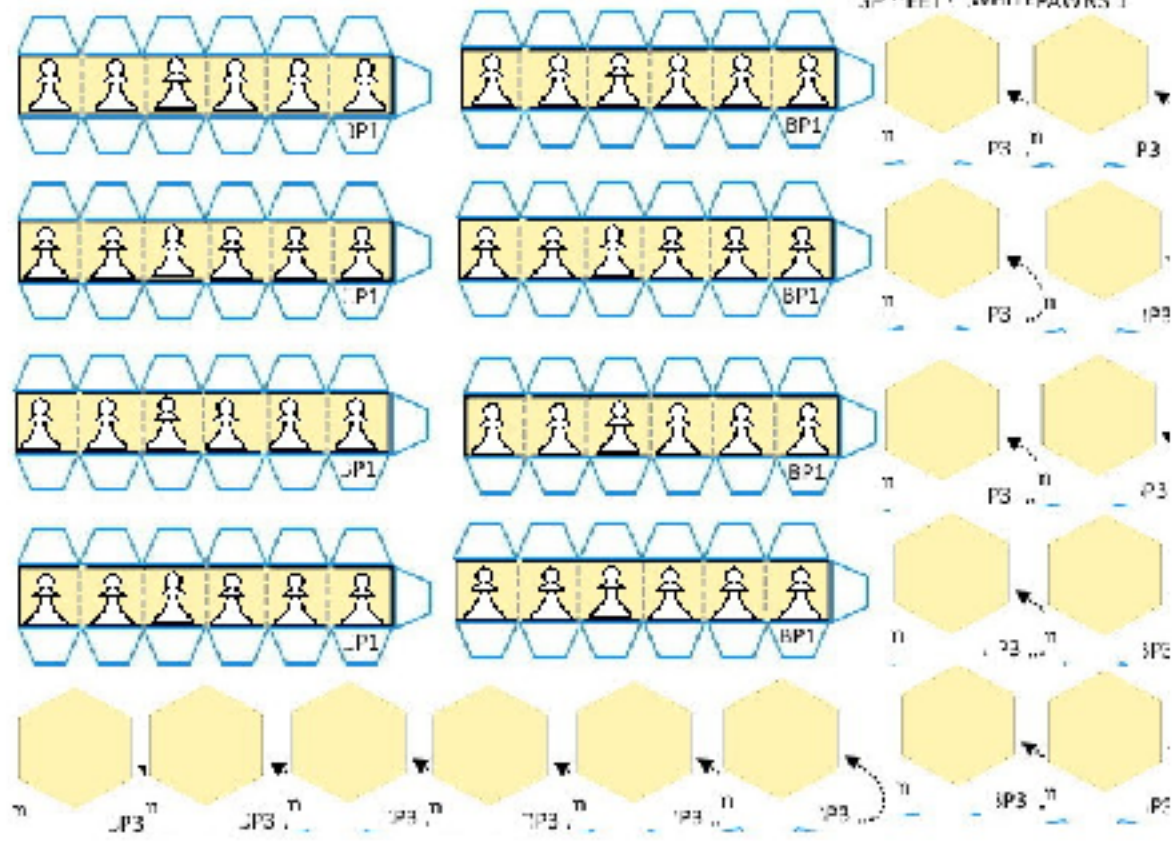



SHEET 8 ROUND BASES BLACK 1

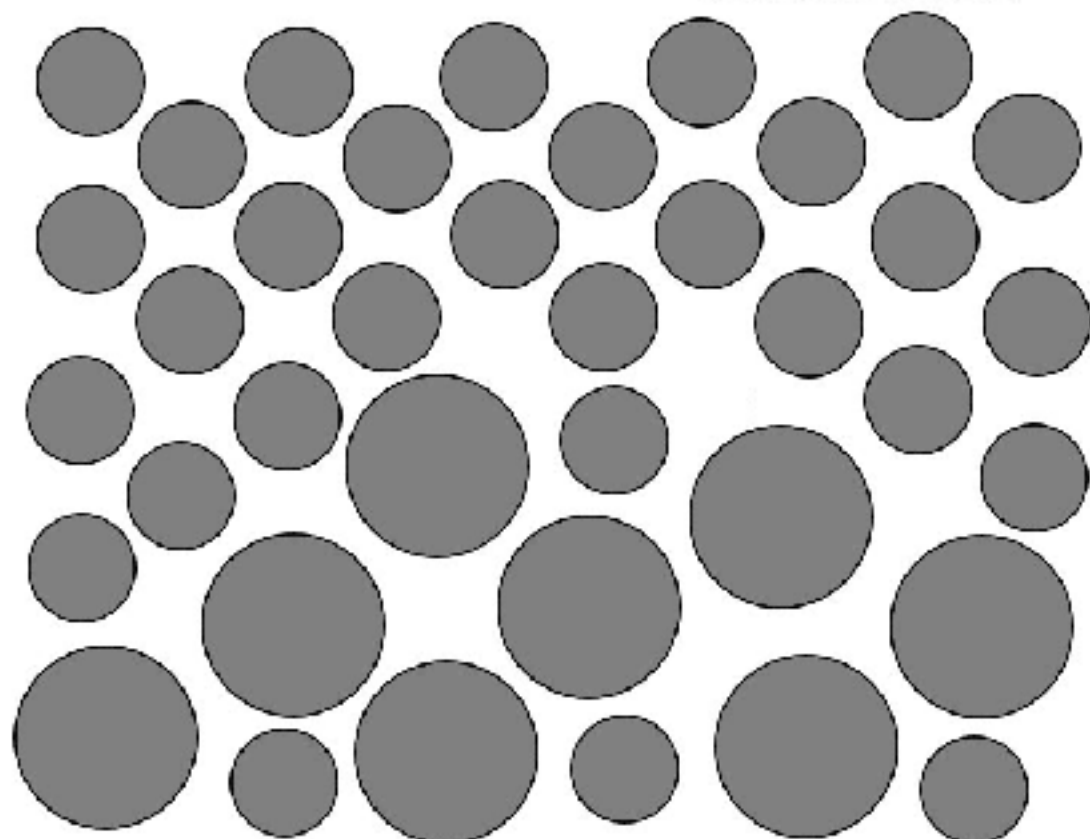

SHEET 8A ROUND BASES 2

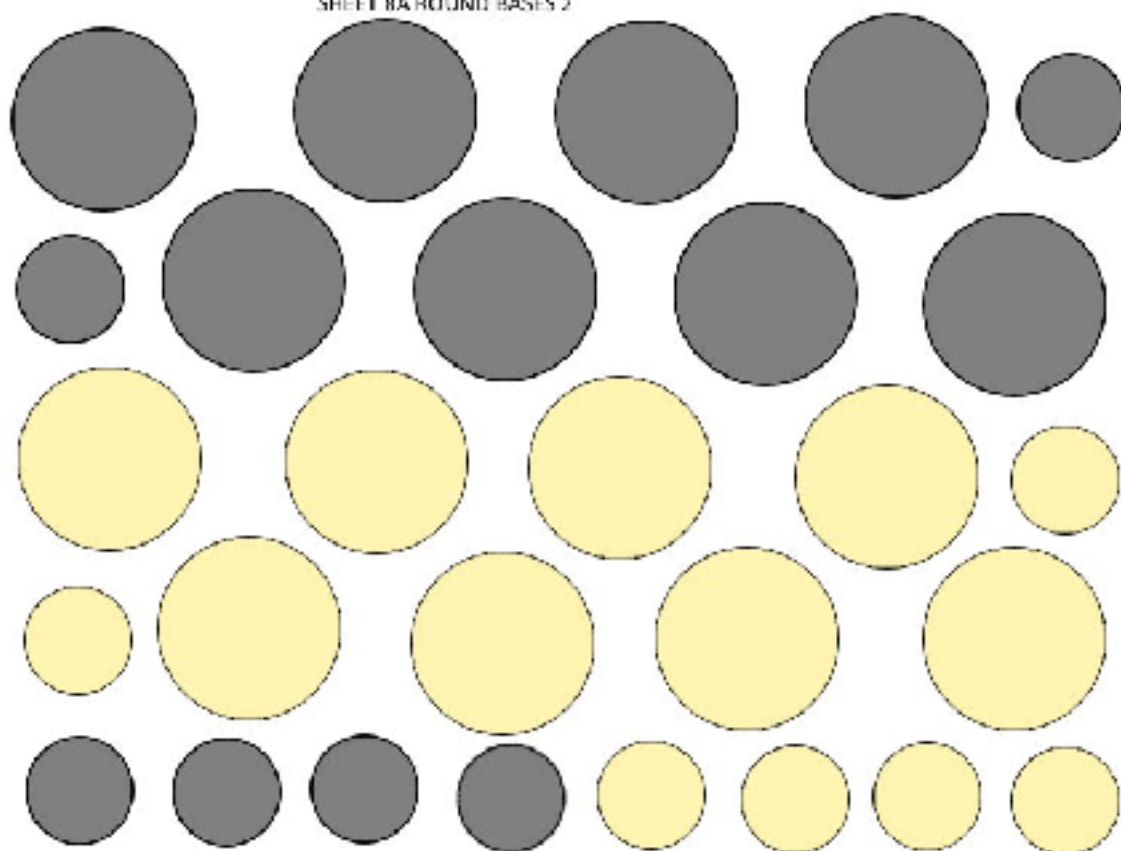

SH-F1 9 ROUND BASES WHITE 1

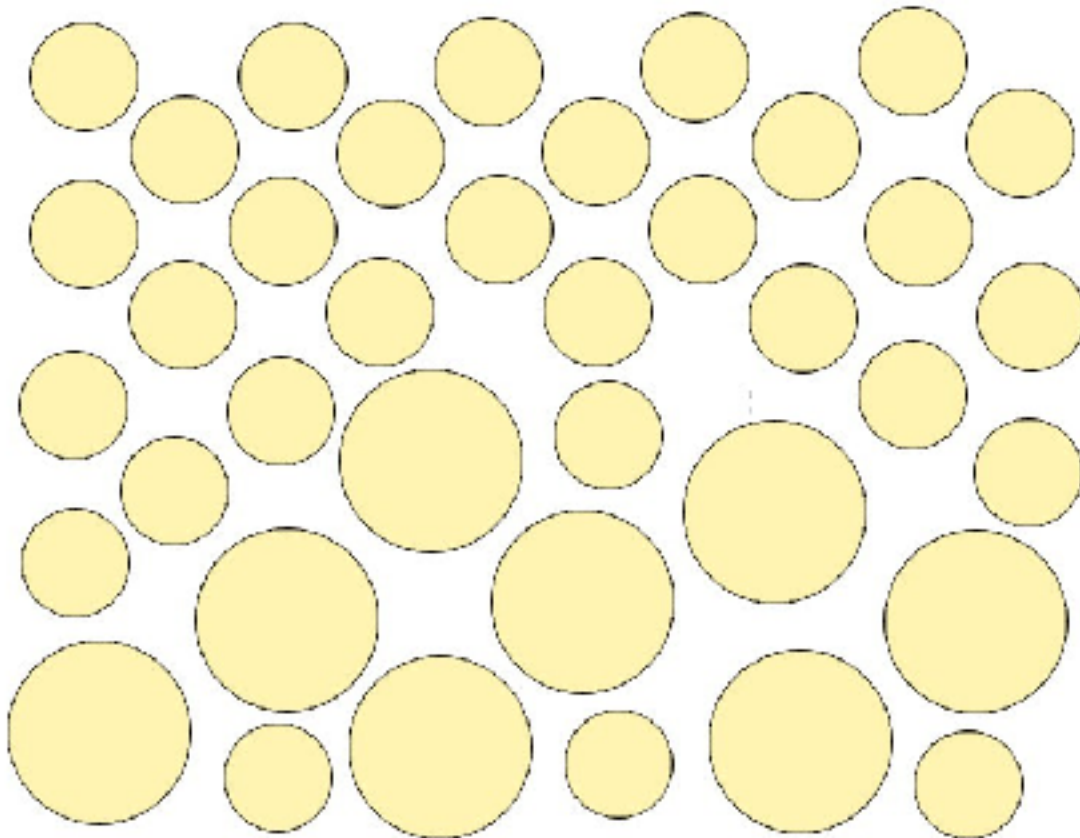

HEXAGONAL STYLE

ROUND STYLE

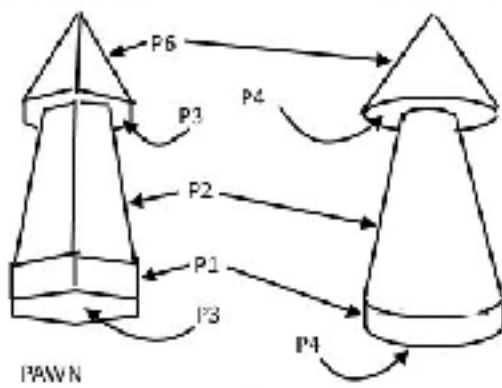

PAWN

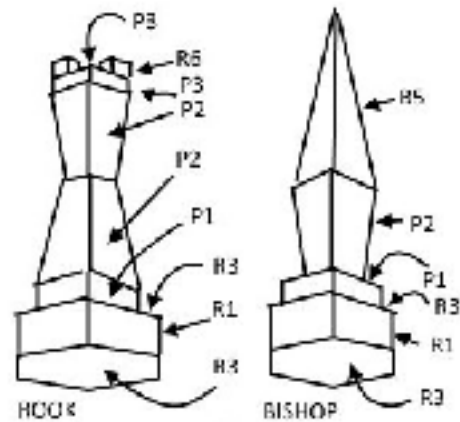

ROOK

BISHOP

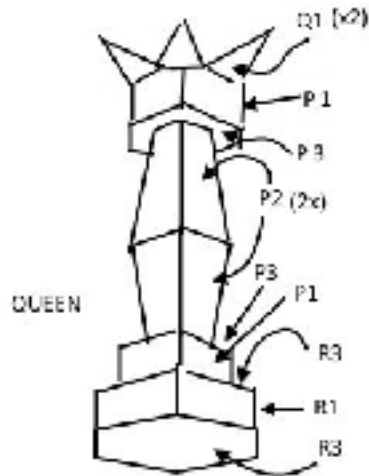

QUEEN

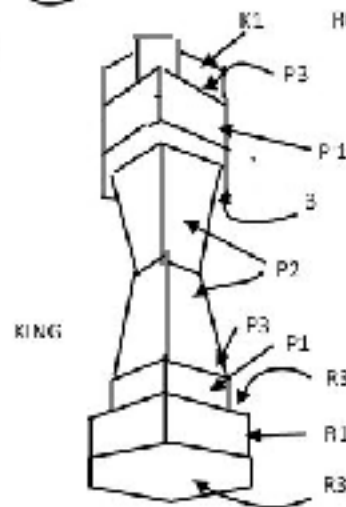

KING

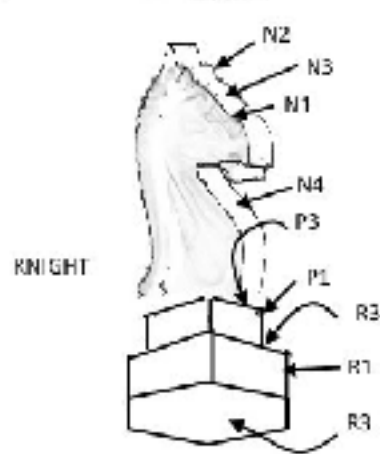

KNIGHT