

# DIY Playseat

## Adjustable and foldable Playseat

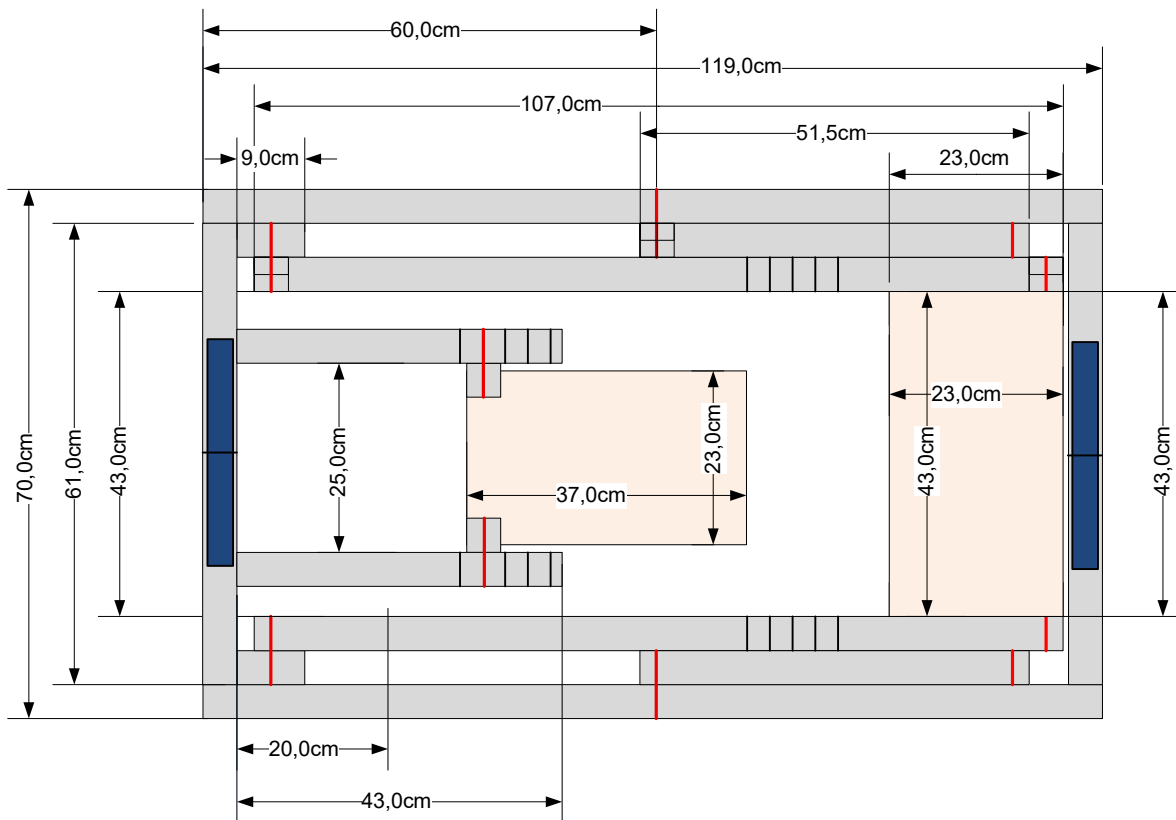

# DIY Playseat: Design and measurements

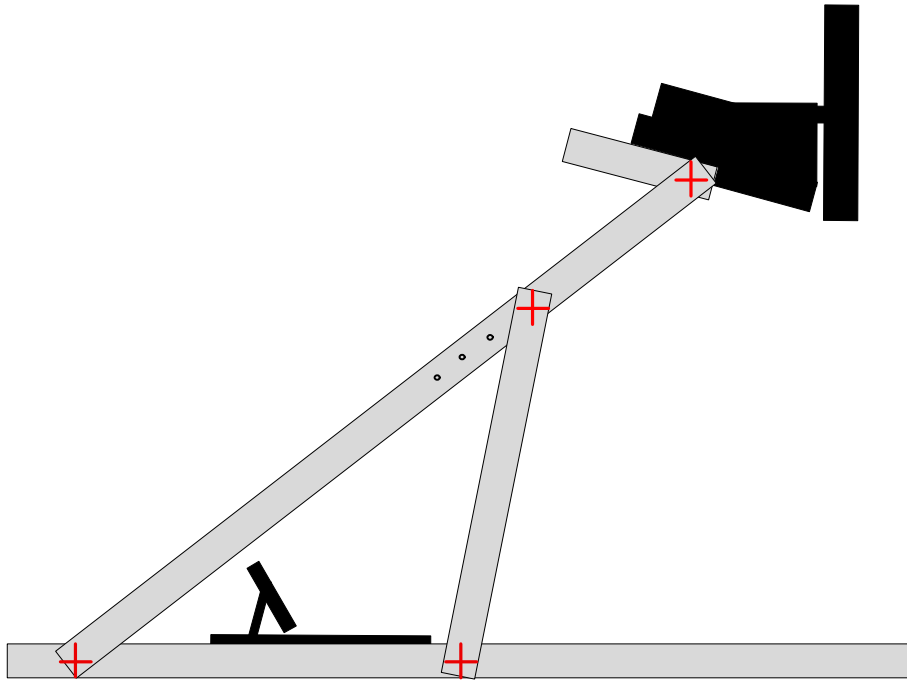

- Lock bolt with butterfly bolt
- Holes (to adjust)

# DIY Playseat: Materials

## Materials

Wooden beams (4x):	45 x 45 x 2400 mm	
Wooden shelf (1x):	80 x 23 x 1,8 mm	
Lock bolt (10x):	M8 x 100 mm	
Butterfly nut (8x):	M8	
Bodywork rings (8x):	M8	
Box hinge (2x)	300 x 40 mm	(optional)
Screws (several):	40 and 80 mm	

## Example materials

<https://www.hornbach.nl/shop/KONSTA-Vuren-balk-geschaafd-44-x-44-x-ca-2400-mm/5185884/artikel.html>  
<https://www.hornbach.nl/shop/DURALINE-Wandplank-4xS-XS2-80x23-5-cm-massief-greunen/10176551/artikel.html>  
<https://www.gamma.nl/assortiment/gamma-slotbout-m8-x-100-mm-verzinkt-15-stuks/p/B458216>  
<https://www.gamma.nl/assortiment/gamma-vleugelmoer-m8-verzinkt-4-stuks/p/B458309>  
<https://www.gamma.nl/assortiment/gamma-carrosseriering-m8-verzinkt-20-stuks/p/B458538>  
<https://www.praxis.nl/gereedschap-installatiemateriaal/ijzerwaren/scharnieren/gah-alberts-kistscharnier-geniete-pen-300x40x2-5mm/10022947>

# DIY Playseat: Instructions (1/3)

1

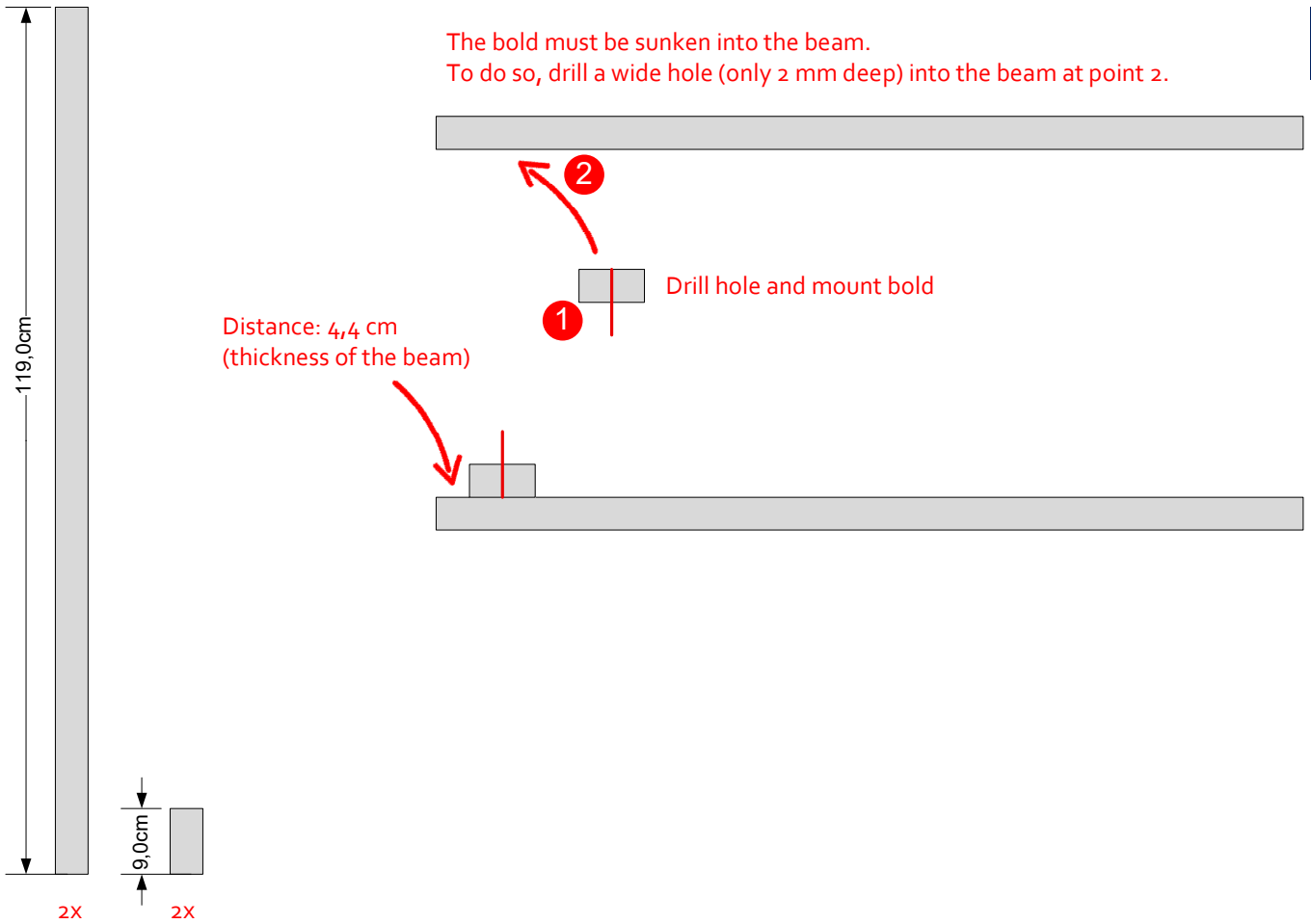

2

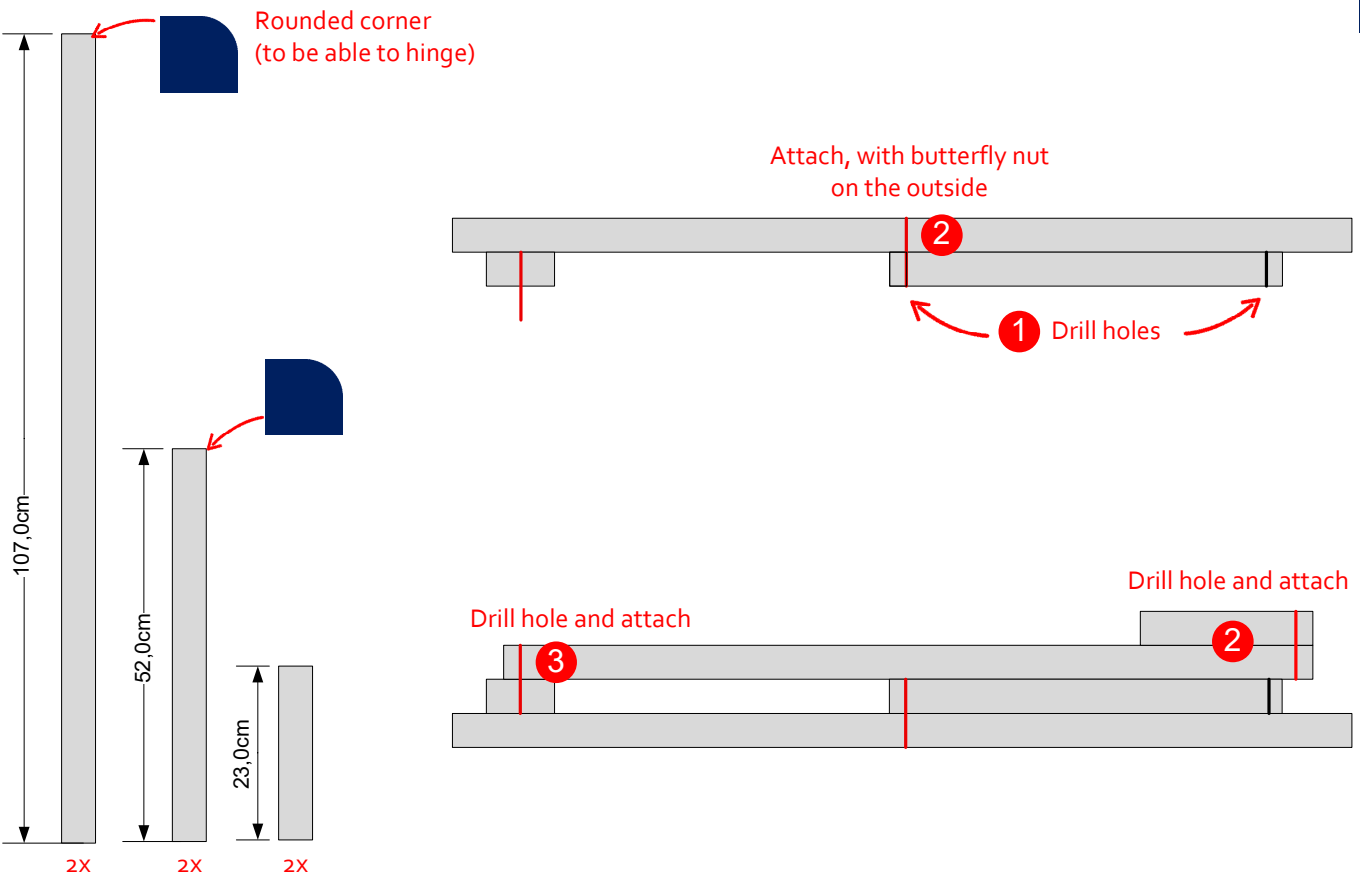

# DIY Playseat: Instructions (2/3)

3

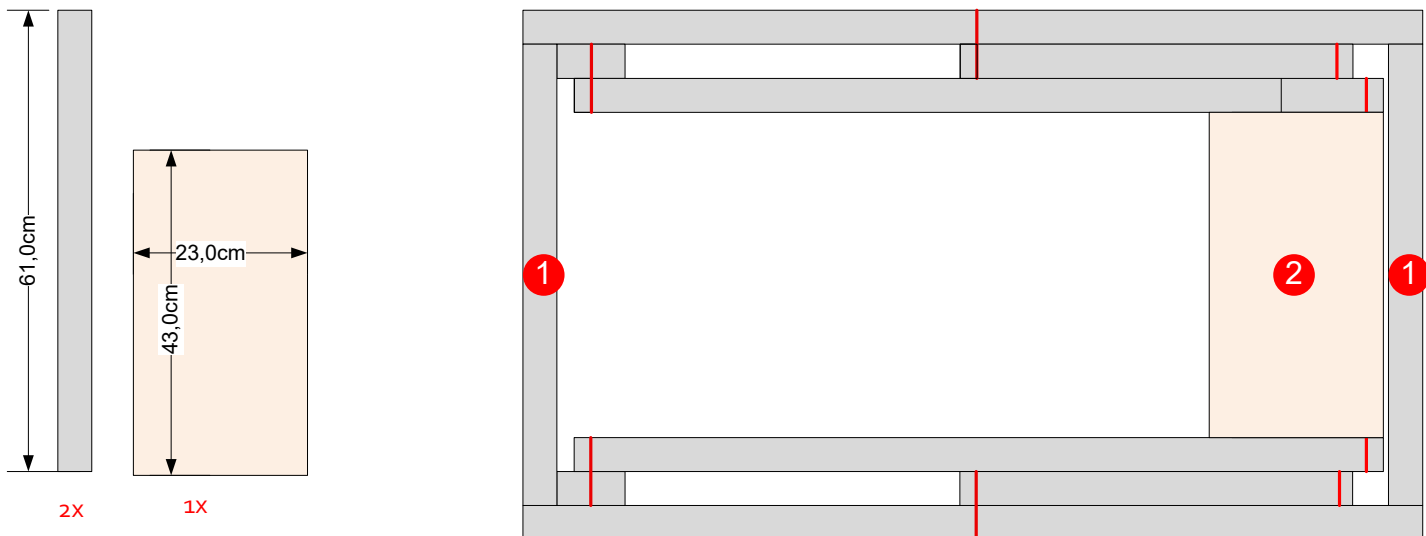

4

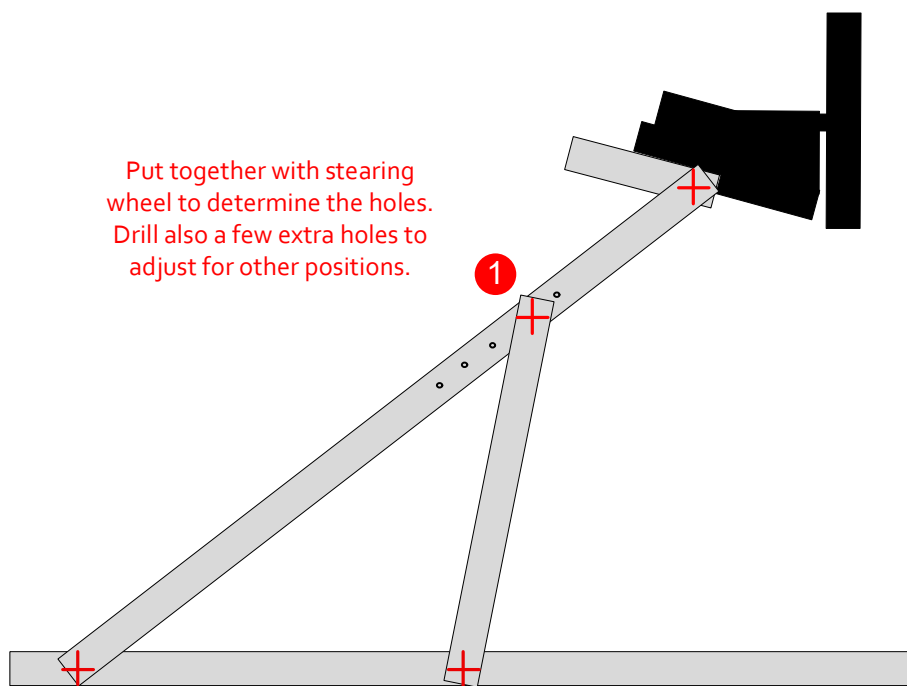

5

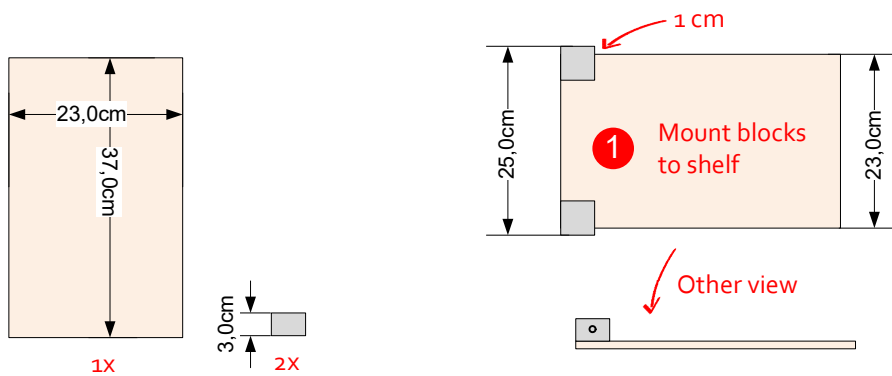

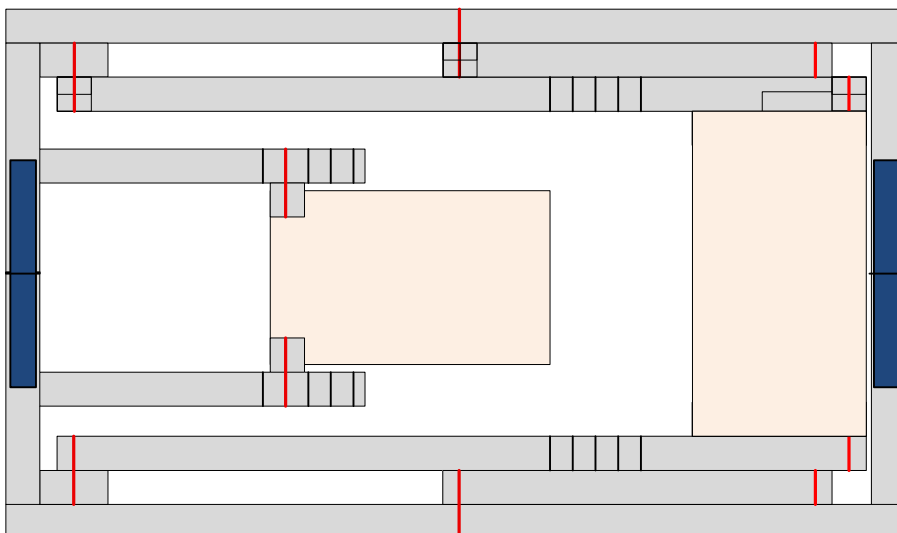
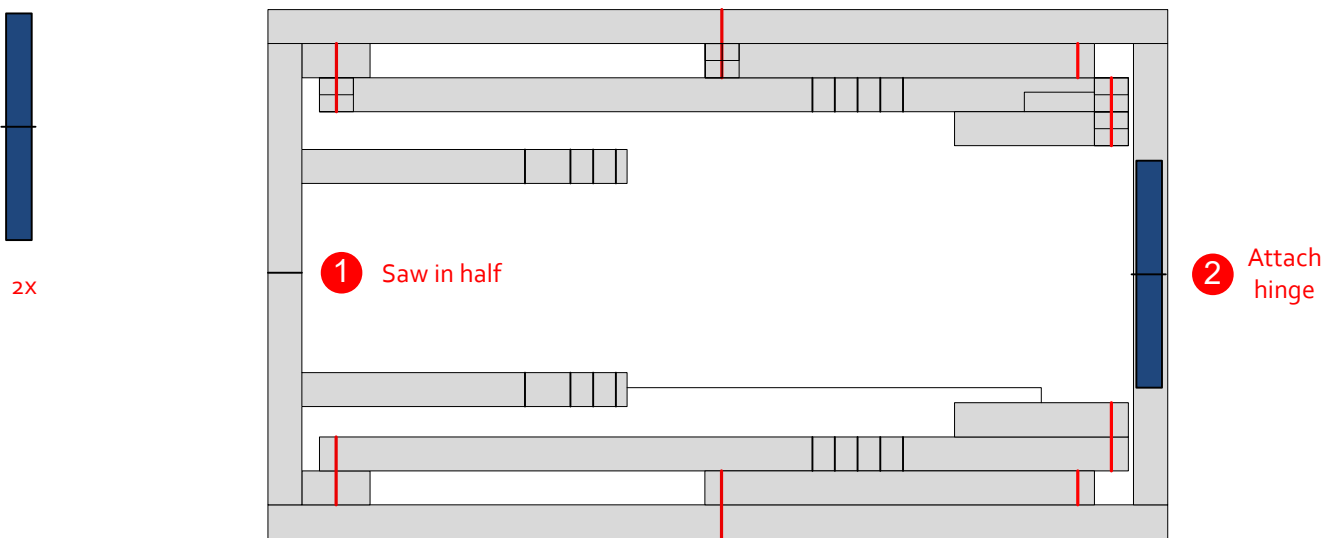
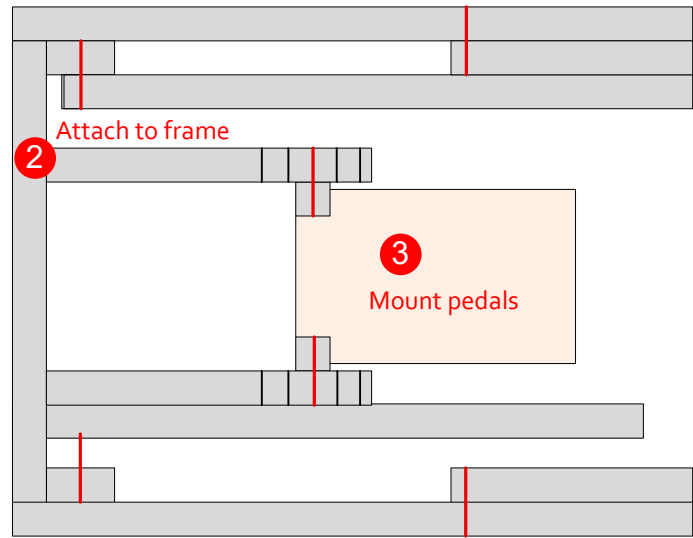
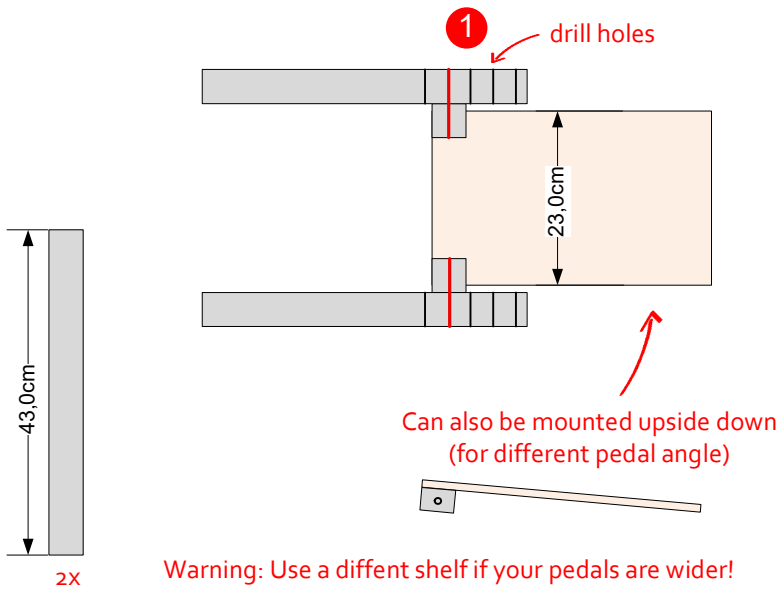

Attach your pedal plate and tabletop and your Playseat is ready for use!