

RDA5807 FM 87-108MHz Radio Receiver LCD1602 DIY Kit

1.Introduction:

It is an RDA5807 87.0MHz-108.0MHz Wireless FM Radio Receiver DIY Kit with RGB spectrum indicator flashing automatically.It has a blue LCD1602 display screen which can clearly display the receiving frequency.

2.Feature:

- 1>.Built-in volume adjustment
- 2>.RGB spectrum indicator flashing automatically
- 3>.Support 87Hz-108MHz receiver frequency
- 4>.Built-in 5W power amplifier
- 5>.LCD1602 display screen

3.Parameter:

- 1>.Product Name:RDA5807 FM 87-108MHz Radio Receiver LCD1602 DIY Kit
- 2>.Work Voltage:DC 4.5V~5.5V
- 3>.Output impedance:4ohm
- 4>.Output power:5W
- 5>.Output channel:Mono
- 6>.Receiver Frequency:87.0MHz~108.0MHz
- 7>.Frequency accuracy:0.1MHz
- 8>.Equivalent noise: >=30dB
- 9>.Work Temperature:-40°C~85°C
- 10>.Work Humidity:5%~95%RH
- 11>.Size(Installed):90*70*55mm

4.Use Methods:

- 1>.Press left button to turn ON/OFF power supply.
- 2>.Press right button to turn ON/OFF spectrum indicator.
- 3>.Press S+ or S- to adjust volume.
- 4>.Press P+ or P- to adjust receive frequency and FM station.

5.Component Listing:

NO.	Component Name	PCB Marker	Parameter	QT Y
1	Metal Film Resistor	R6	10ohm	1
2	Metal Film Resistor	R19,R20	100ohm	2
3	Metal Film Resistor	R12,R15	6.8Kohm	2
4	Metal Film Resistor	R9,R13,R16,R17	1Kohm	4
5	Metal Film Resistor	R1-R5,R7,R8,R11,R14,R15,R18	10Kohm	11
6	RDA5807 FM Receiver	U2	SMD	1
7	Crystal Oscillator	Y1	11.0592MHz	1
8	IC Socket	U3	DIP-8	1
9	IC Socket	U1	DIP-40	1
10	Ceramic Capacitor	C1,C2	22pF	2
11	Monolithic Capacitor	C10,C12,C13	0.1uF 104	3
12	KA2284 LED Driver	KA2284	ZIP-9	2

13	RGB LED	LED1-LED10	5mm	10
14	DuPont Female Socket	LCD1602 J9	16Pin	1
15	Male Pin	LCD1602	16Pin	1
16	Electrolytic Capacitor	C3,C5,C6,C7,C8,C11,C14,C15,C16	4.7uF	9
17	Electrolytic Capacitor	C4,C9	100uF	2
18	1N4148 Diode	D11	DO-35	1
19	1N4007 Diode	D12,D13	DO-41	2
20	DC-005 Power Socket	J1	5.5*2.5mm	1
21	Self-locking Button	S4,S6	5.8*5.8mm	2
22	Self-locking Button Cap	S4,S6	Red	1
23	Black Button	S1,S2,S3,S5 or S+/S-/P+/P-	6*6*20mm	4
24	LM386N	U3	DIP-8	1
25	STC89C52RC	U1	DIP-40	1
26	LCD1602 Display Screen	LCD1602	Blue	1
27	75ohm Antenna	ANT	25cm	1
28	4ohm 5W Speaker	SP	22mm	1
29	Red/Black Speaker Wire	SP	20cm	1
30	USB-DC005 Power Wire		100cm	1
31	Acrylic Board			6
32	M3*10mm Copper Pillar			4
33	M3*10mm Screw			4
34	M3*8mm Screw			4
35	M3*6mm Screw			14
36	Nut			18
37	PCB		82*64*1.6mm	1

Note:Users can complete the installation according to the PCB silk screen and component list.

6.Schematic Diagram:

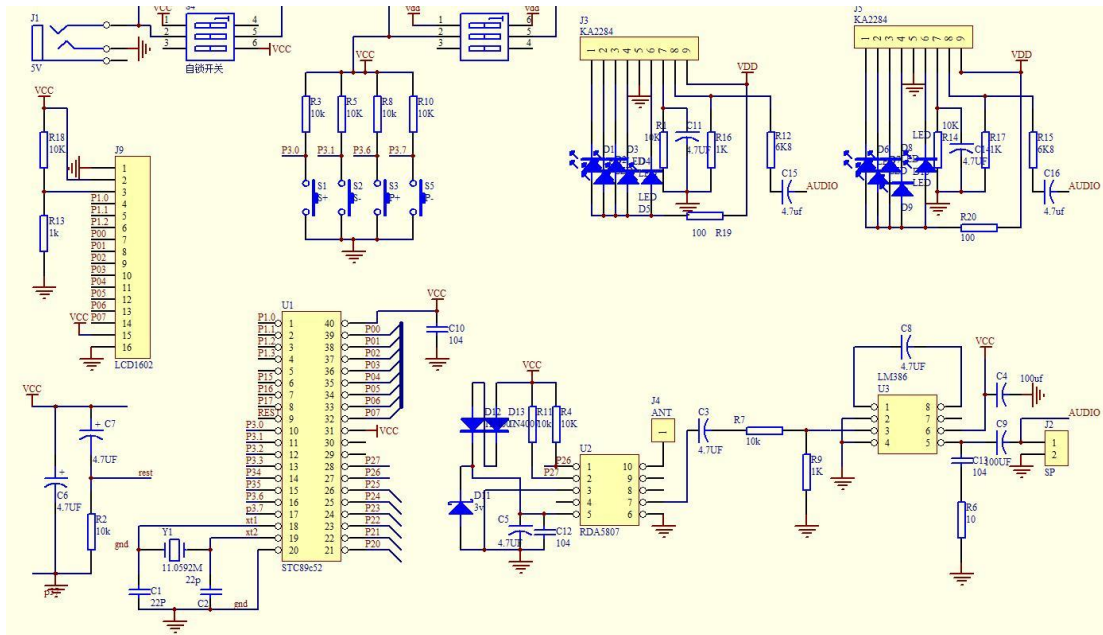

7.Application:

- 1>.Training welding skills
- 2>.Student school
- 3>.DIY production
- 4>.Project Design
- 5>.Electronic competition
- 6>.Gift giving
- 7>.Crafts collection
- 8>.Home decoration
- 9>.Souvenir collection
- 10>.Graduation design
- 11>.Holiday gifts

8.Note:

- 1>.It is a wireless module. So do not use it in an environment with signal interference.
- 2>.There is a SMD component so that you can place it on PCB and then fix by tin.

9.Installation Tips:

- 1>.User needs to prepare the welding tool at first.
 - 1.1>.Soldering iron (<50 Watt)
 - 1.2>.Rosin core ("radio") solder
 - 1.3>.Wire cutters
 - 1.4>.Wire strippers
 - 1.5>.Philips screwdriver
- 2>.Please be patient until the installation is complete.
- 3>.The package is DIY kit.It need finish install by user.
- 4>.The soldering iron can't touch the components for a long time(1.0 second), otherwise it will damage the components.
- 5>.Pay attention to the positive and negative of the components.
- 6>.Strictly prohibit short circuit.

7>.User must install the LED according to the specified rules.Otherwise some LED will not light.

8>.Install complex components preferentially.

9>.Make sure all components are in right direction and right place.

10>.It is strongly recommended to read the installation manual before starting installation!!!

11>.Please wear anti-static gloves or anti-static wristbands when installing electronic components.

10.Installation Steps(Please be patient install!!!):

1>.Step 1: Install 1pcs SMD components RDA5807 FM Receiver at U2. Verify and confirm the installation direction of RDA5807. The rectangular silk screen on the PCB coincides with the crystal oscillator on the RDA5807 to locate the installation direction. **Note: PCB has 2 versions: Older version comes with blue RDA5807 receiver. Newer version comes with green RDA5807 receiver.**

2>.Step 2: Randomly choose a pad on the PCB, and then melt the solder on this pad.

3>.Step 3: Fix RDA5807: Use a soldering iron to melt tin on the pad just now and hold RDA5807 with tweezers in the other hand to place/press on U2 to prevent movement. Take care to match and align each pads. Then remove soldering iron. Then remove tweezers after solder tin cooling and solidification.

4>.Step 4: Connect others pads on RDA5807 to pads on PCB by tin and soldering iron.

5>.Step 5: Install 1pcs 10ohm Metal Film Resistor at R6.

6>.Step 6: Install 2pcs 100ohm Metal Film Resistor at R19,R20.

7>.Step 7: Install 2pcs 6.8Kohm Metal Film Resistor at R12,R15.

8>.Step 8: Install 4pcs 1Kohm Metal Film Resistor at R9,R13,R16,R17.

9>.Step 9: Install 11pcs 10Kohm Metal Film Resistor at R1-R5,R7,R8,R11,R14,R15,R18.

10>.Step 10: Install 1pcs DO-35 1N4148 Diode at D11. Pay attention to the installation direction. There is a black mark on 1N4148 and a white mark on PCB which are used to confirm the installation direction. **Note: PCB has 2 versions: Older version no need install 1N4148 and comes with blue RDA5807 receiver. Newer version need install 1N4148 and comes with green RDA5807 receiver.**

11>.Step 11: Install 2pcs DO-41 1N4007 Diode at D12,D13. Pay attention to the installation direction. There is a black mark on 1N4007 and a white mark on PCB which are used to confirm the installation direction. **Note: PCB has 2 versions: Older version no need install 1N4007 and comes with blue RDA5807 receiver. Newer version need install 1N4007 and comes with green RDA5807 receiver.**

12>.Step 12: Install 1pcs 11.0592MHz Crystal Oscillator at Y1.

13>.Step 13: Install 1pcs DIP-8 IC Socket at U3. There is a gap mark on one end of the IC Socket and there is a gap mark on PCB silk screen where the IC Socket can place on. These two marks are corresponding to each other and are used to specify the installation direction of the IC Socket.

14>.Step 14: Install 1pcs DIP-40 IC Socket at U1. There is a gap mark on one end of the IC Socket and there is a gap mark on PCB silk screen where the IC Socket can place on. These two marks are corresponding to each other and are used to specify the installation direction of the IC Socket.

15>.Step 15: Install 2pcs 22pF Ceramic Capacitor at C1,C2.

16>.Step 16: Install 3pcs 0.1uF 104 Monolithic Capacitor at C10,C12,C13.

17>.Step 17: Confirm and identify the installation direction of the KA2284.

18>.Step 18: Install 2pcs ZIP-9 KA2284 LED Driver at KA2284.

19>.Step 19: Identify the positive(anode) and negative(cathode) lead of LED.The leads of the LED must be installed correctly, otherwise the LED cannot be turned on.Here are four methods as following:

19.1>.According to the length of the LED lead to distinguish. The longer pin is positive(anode) lead. The shorter pin is negative(cathode) lead.

19.2>.Identify the negative(cathode) of the LED is to look into the plastic case where one can see that the negative(cathode) is much thicker/bigger inside the plastic case than the anode lead.

19.3>.Identify by edge of plastic case.The negative(cathode) lead of the LED should be the pin nearest the flat on the plastic case.

19.4>.Test by 3V battery or multimeter.The pin is positive(anode) lead which has connect to the positive of 3V if LED can light up after connect 3V power supply.(LED should not be powered directly from the 3V for a short time:less then 0.5second)

19.5>.It is positive(anode) where the white mark “+” pointing to on PCB.

20>.Step 20: Install 10pcs 5mm RGB LED at LED1-LED10.

21>.Step 21: Install 1pcs 16Pin DuPont Female Socket at LCD1602.

22>.Step 22: Bend the pins of only one 4.7uF electrolytic capacitor about 2mm.

Note:Just for only one!

23>.Step 23: Install this Electrolytic Capacitor at C7. Pay attention to distinguish between positive and negative. The Longer pin is positive pole. Note: The capacitor needs to be placed horizontally. Otherwise, the following components cannot be installed.

24>.Step 24: Install others 8pcs 4.7uF Electrolytic Capacitor at C3, C5, C6, C8, C11, C14, C15, C16 .Pay attention to distinguish between positive and negative.The Longer pin is positive pole. Note: The capacitor needs to be placed horizontally, keep a distance of 2mm between the capacitor and the PCB when installing.

25>.Step 25 Install 2pcs 4.100uF Electrolytic Capacitor at C4,C9.Pay attention to distinguish between positive and negative.The Longer pin is positive pole. Note: The capacitor needs to be placed horizontally, keep a distance of 2mm between the capacitor and the PCB when installing.

26>.Step 26: Install 1pcs DC-005 Power Socket at J1.

27>.Step 27: Install 2pcs 5.8*5.8mm Self-locking Button at S4,S6.

28>.Step 28: Install 4pcs 6*6*20mm Black Button atS1,S2,S3,S5.

29>.Step 29: Install 1pcs DIP-8 IC LM386N at U3.There is a gap mark on one end of the IC and there is a gap mark on DIP-8 IC Socket where the IC can place on.These two marks are corresponding to each other and are used to specify the installation direction of the IC.

30>.Step 30: Install 1pcs DIP-40 IC STC89C52RC.There is a gap mark on one end of the IC and there is a gap mark on DIP-40 IC Socket where the IC can place on.These two marks are corresponding to each other and are used to specify the installation direction of the IC.

31>.Step 31 Fix 4pcs M3*10mm Copper Pillar and 4pcs M3*8mm Screw on PCB.

32>.Step 32: Install 1pcs 16Pin Male Socket on the back of LCD1602 display screen. Note the black plastic block on the back of the LCD. Please cut off the extra pins with scissors and reserve the 16pin, if you receive it is 20pin or 22pin or other.

33>.Step 33: Plug LCD1602 display screen on 16Pin DuPont Female Socket.

Note: Don't use screws to fix it for now.

34>.Step 34: Install 1pcs 75ohm Antenna at ANT. Keep a distance more than 5mm from PCB and fix by tin(not screw). Note that the antenna should be installed on the back of the PCB.

35>.Step 35: Place 2pcs red button cap on Self-locking Button.

36>.Step 36: Connect speaker to PCB at SP by 20cm red/black Cable. The speaker does not distinguish between positive and negative.

37>.Step 37: Tear off the protective film on the surface of the acrylic shell.

38>.Step 38: Fix Top Acrylic Board and LCD1602 Acrylic Board on Copper Pillar by 4pcs M3*6mm Screw.

39>.Step 39: Fix 4pcs Side Acrylic Board by 6pcs M3*6mm Screw and 6pcs M3 Nuts.

40>.Step 40: Fix speaker on Acrylic Bottom Board by 4pcs M3*10mm Screws and 4pcs M3 Nuts.

41>.Step 41: Install Speaker Acrylic Board by 4pcs M3*6mm Screw and 4pcs M3 Nuts.

42>.Step 42: Connect to power supply and enjoy the effect.

11. Install shown steps:

Step 1: Install 1pcs SMD components RDA5807 FM Receiver at U2. Verify and confirm the installation direction of RDA5807. The rectangular silk screen on the PCB coincides with the crystal oscillator on the RDA5807 to locate the installation direction.

Note: PCB has 2 versions:
 Older version comes with blue RDA5807 receiver.
 Newer version comes with green RDA5807 receiver.

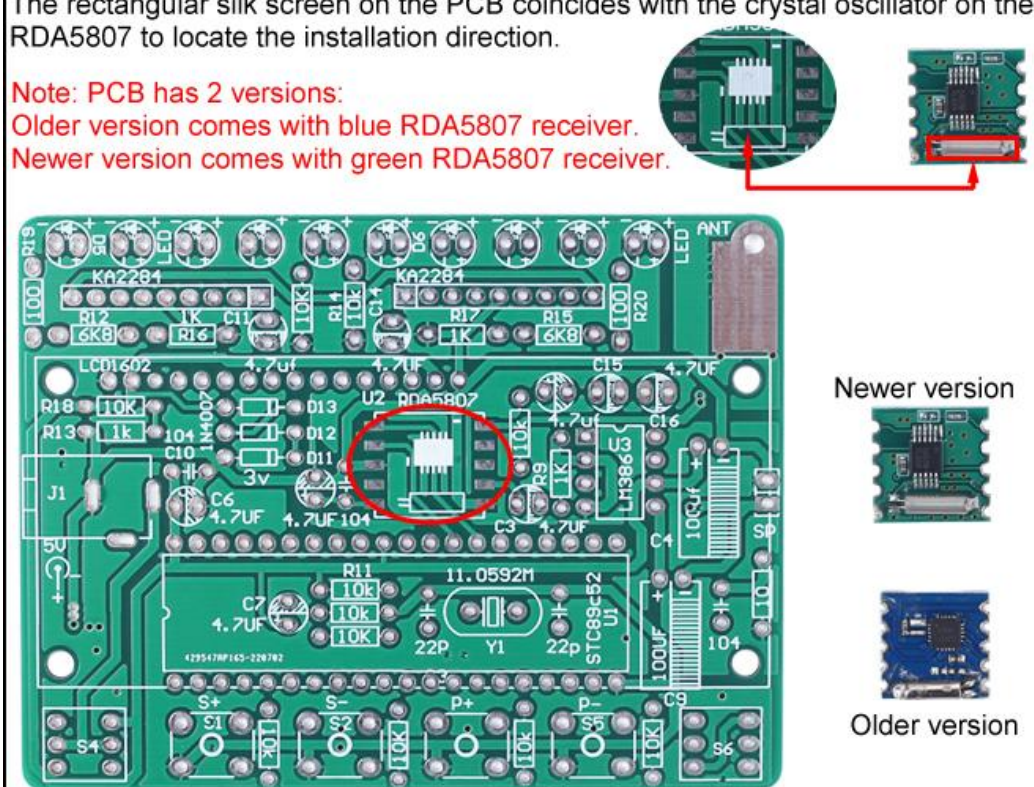

The main image shows the PCB with various components labeled. The RDA5807 receiver (U2) is highlighted with a red circle. The PCB also features a crystal oscillator (Y1) and a silk screen that coincides with the crystal oscillator on the RDA5807 to indicate the installation direction.

Newer version

Older version

Step 2: Randomly choose a pad on the PCB, and then melt the solder on this pad.

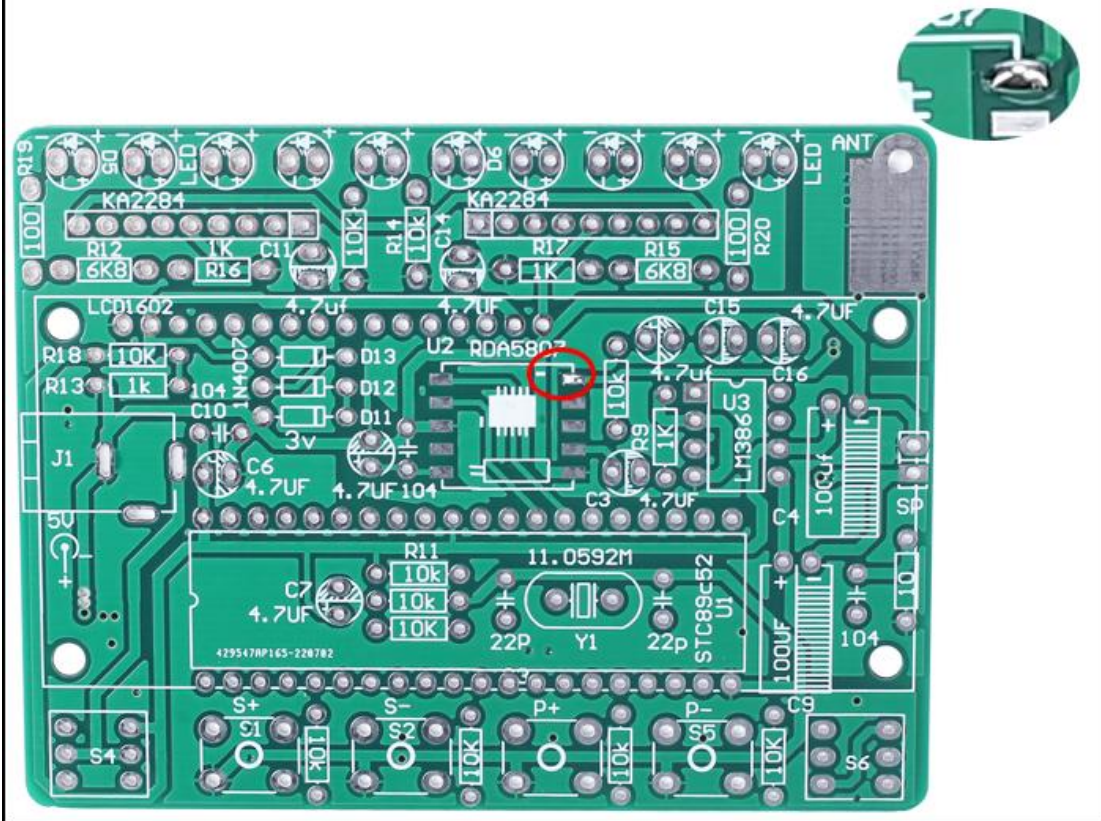

Step 3: Fix RDA5807: Use a soldering iron to melt tin on the pad just now and hold RDA5807 with tweezers in the other hand to place/press on U2 to prevent movement. Take care to match and align each pads. Then remove soldering iron. Then remove tweezers after solder tin cooling and solidification.

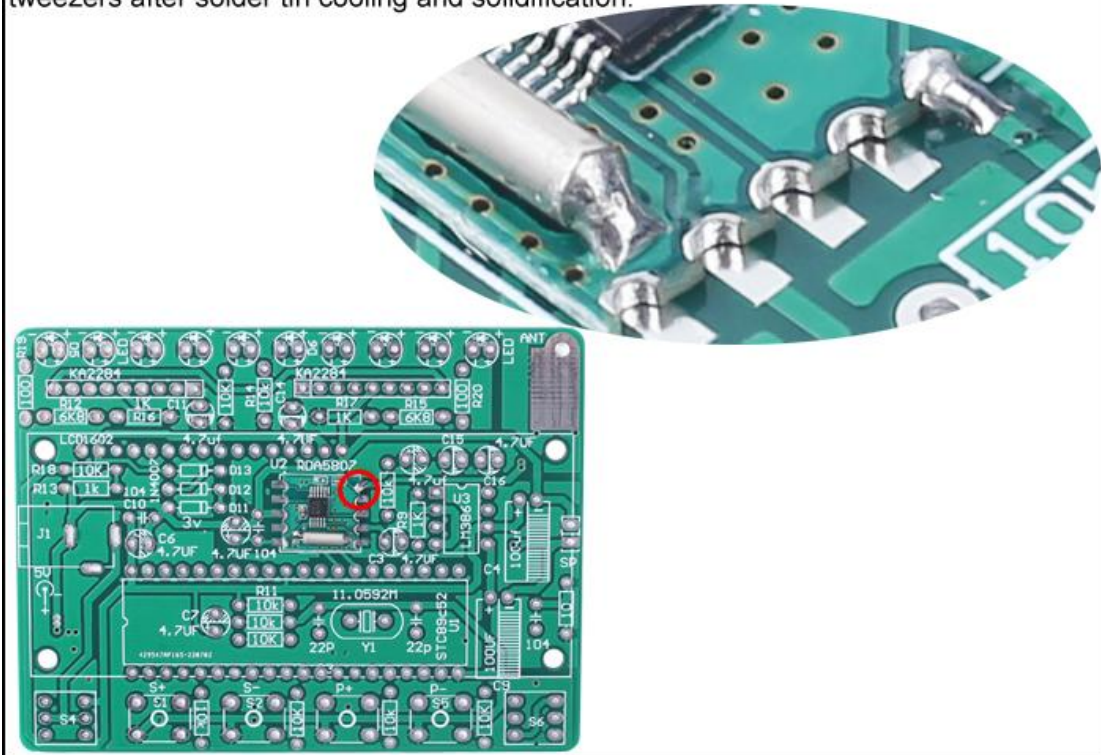

Step 4: Connect others pads on RDA5807 to pads on PCB by tin and soldering iron.

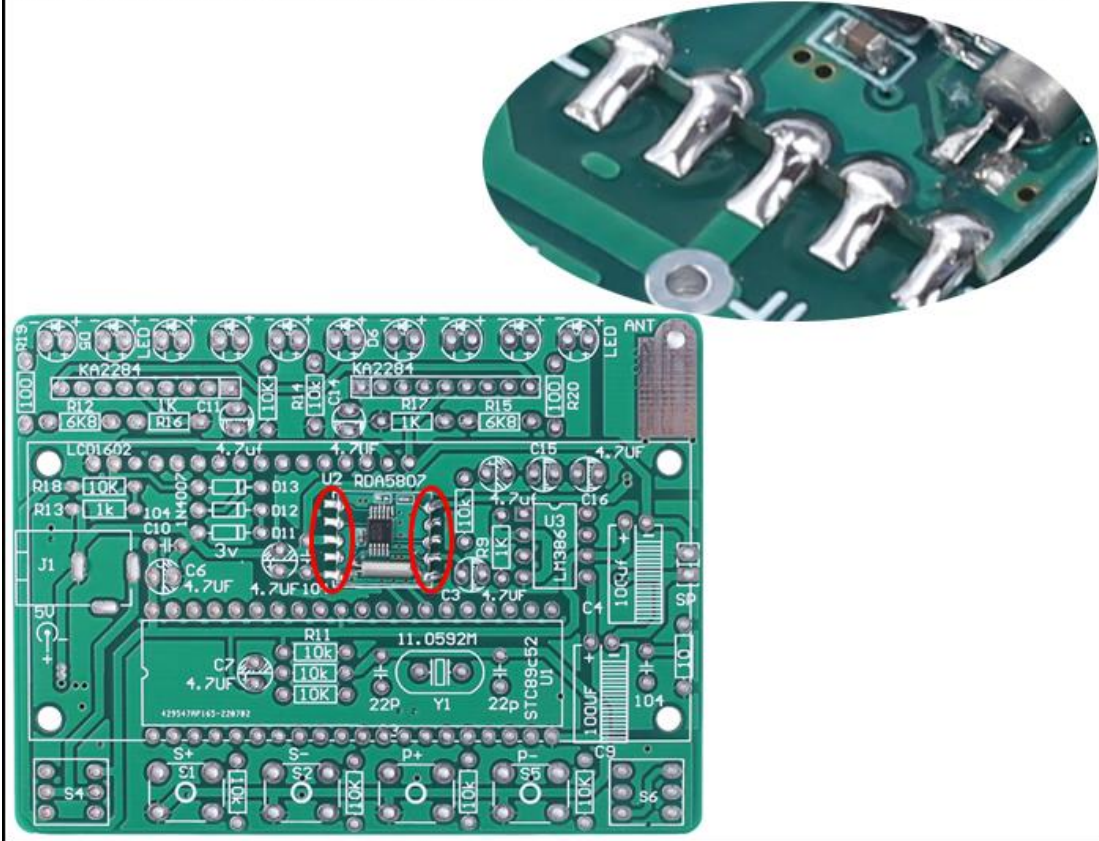

Step 5: Install 1pcs 10ohm Metal Film Resistor at R6.

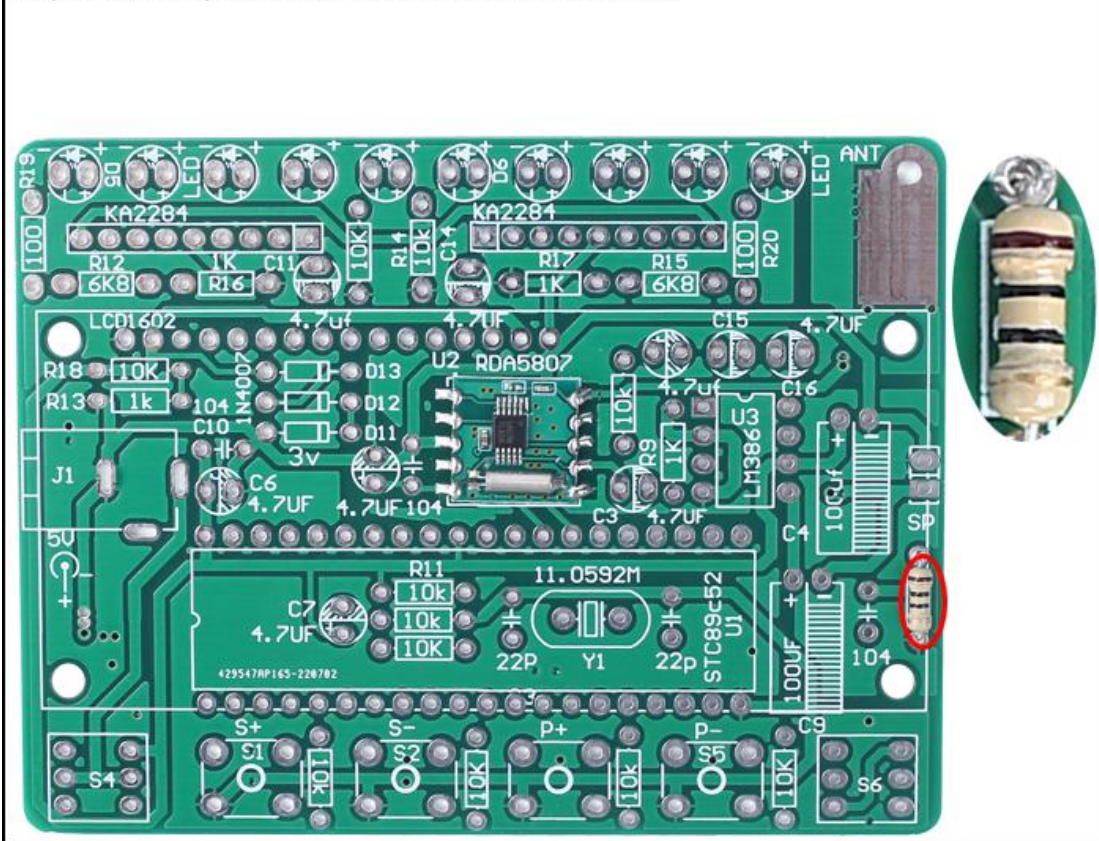

Step 6: Install 2pcs 100ohm Metal Film Resistor at R19,R20.

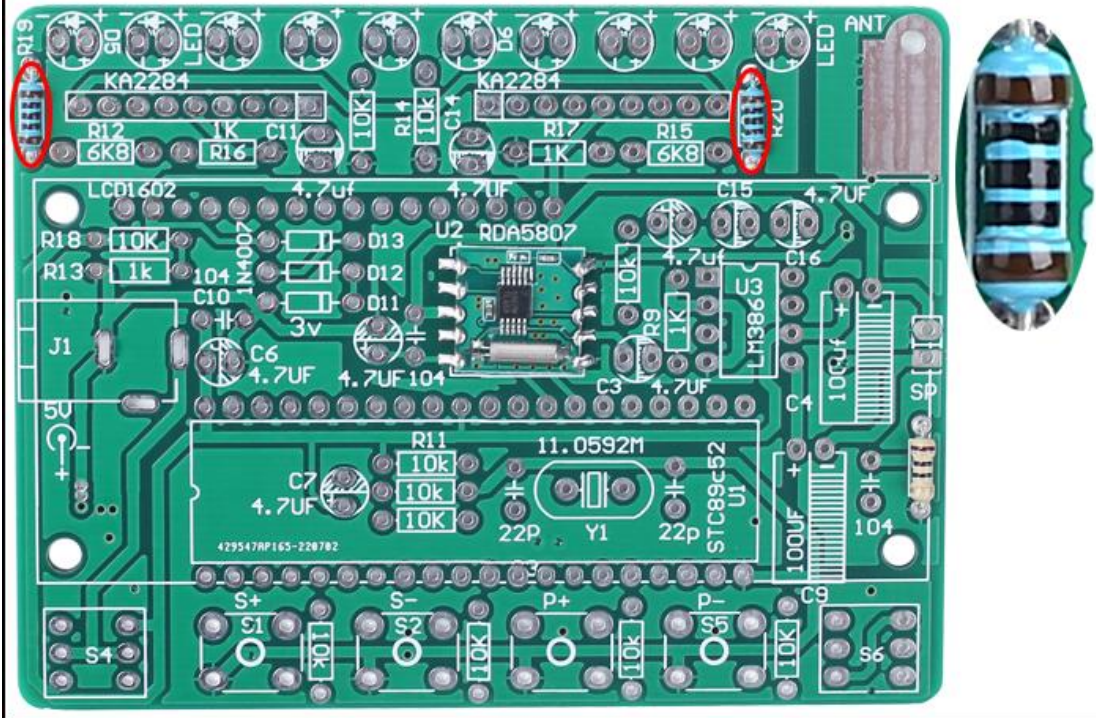

Step 7: Install 2pcs 6.8Kohm Metal Film Resistor at R12,R15.

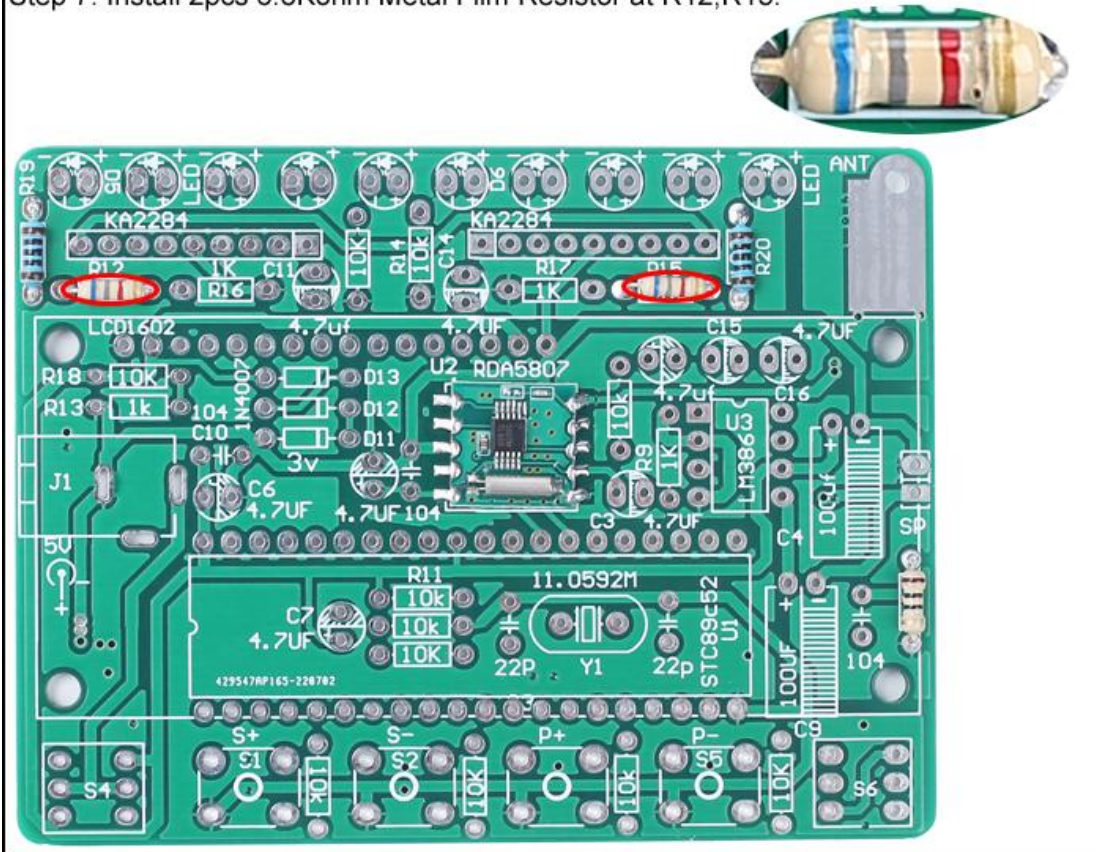

Step 8: Install 4pcs 1Kohm Metal Film Resistor at R9,R13,R16,R17.

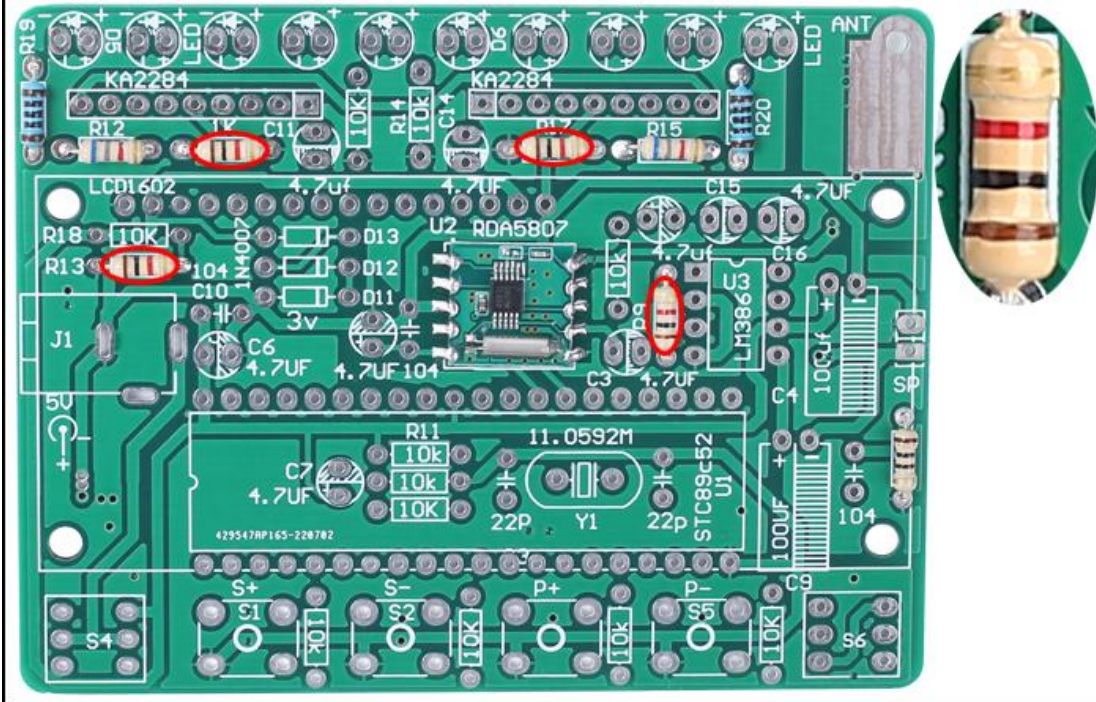

Step 9: Install 11pcs 10Kohm Metal Film Resistor at R1-R5,R7,R8,R11,R14,R15,R18.

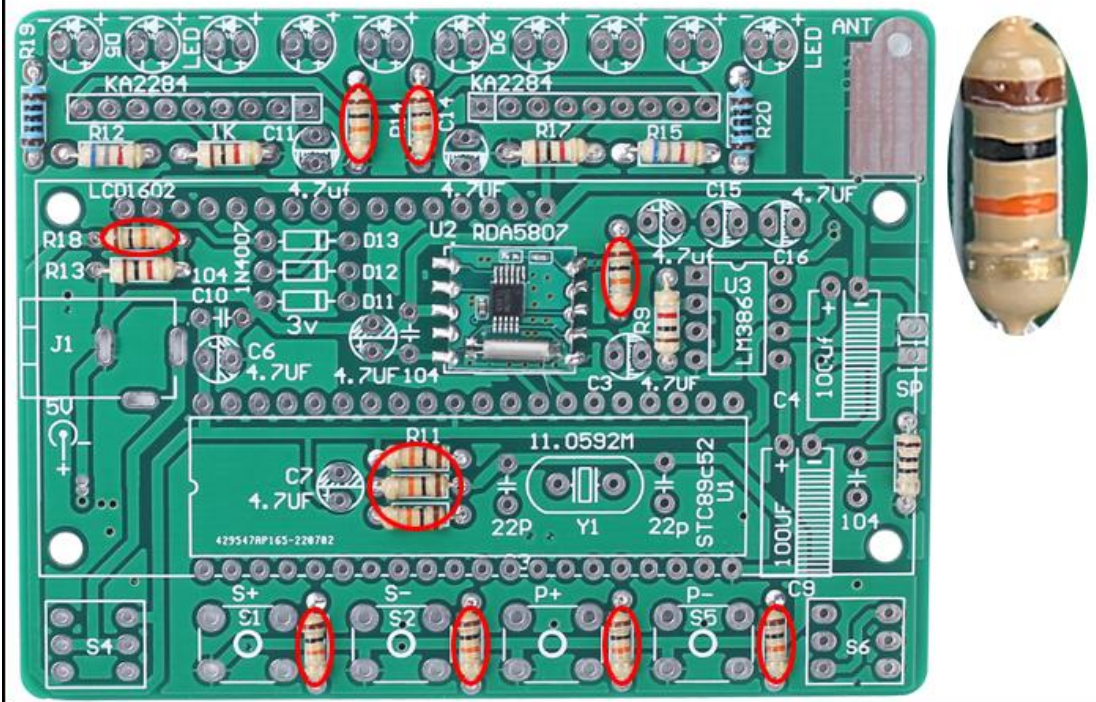

Step 10: Install 1pcs DO-35 1N4148 Diode at D11. Pay attention to the installation direction. There is a black mark on 1N4148 and a white mark on PCB which are used to confirm the installation direction.

Note: PCB has 2 versions: Older version no need install 1N4148 and comes with blue RDA5807 receiver.

Newer version need install 1N4148 and comes with green RDA5807 receiver.

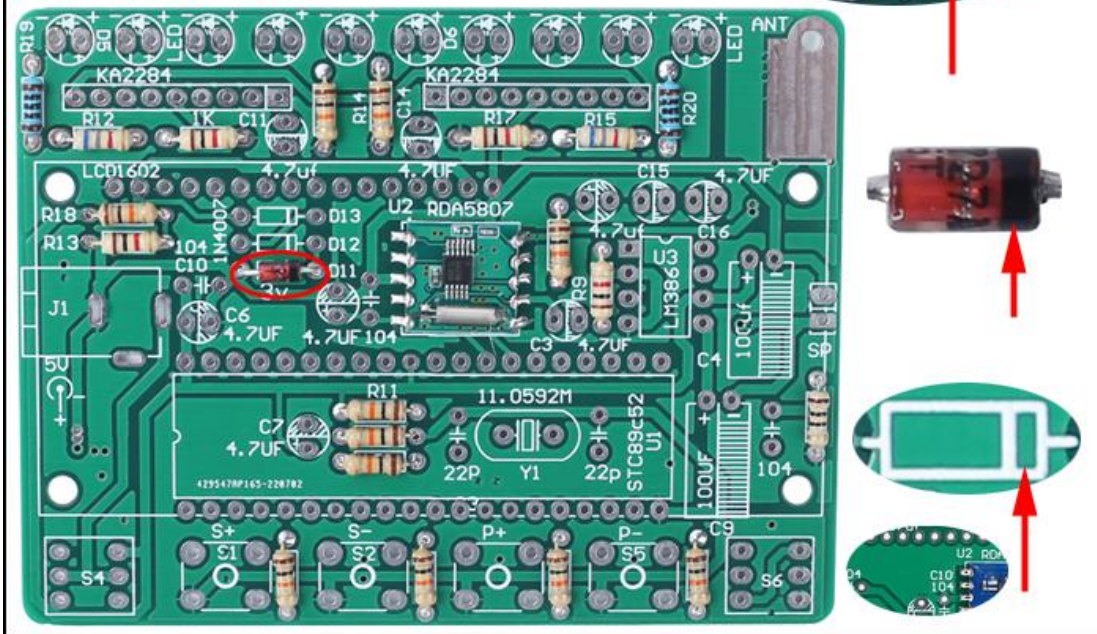

Step 11: Install 2pcs DO-41 1N4007 Diode at D12,D13. Pay attention to the installation direction. There is a black mark on 1N4007 and a white mark on PCB which are used to confirm the installation direction.

Note: PCB has 2 versions: Older version no need install 1N4007 and comes with blue RDA5807 receiver.

Newer version need install 1N4007 and comes with green RDA5807 receiver.

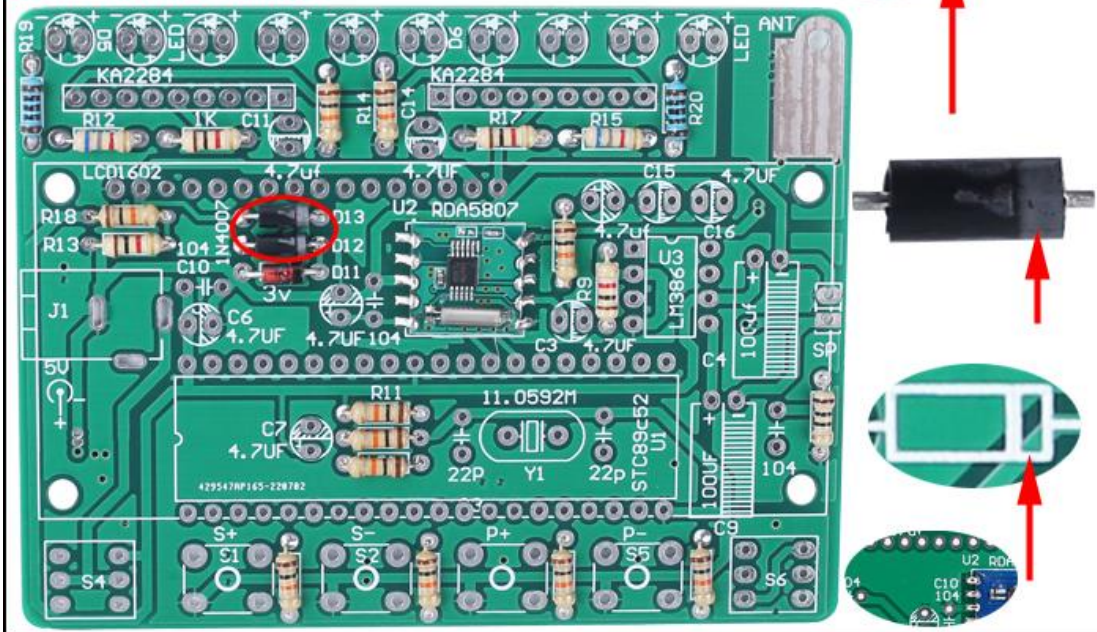

Step 12: Install 1pcs 11.0592MHz Crystal Oscillator at Y1.

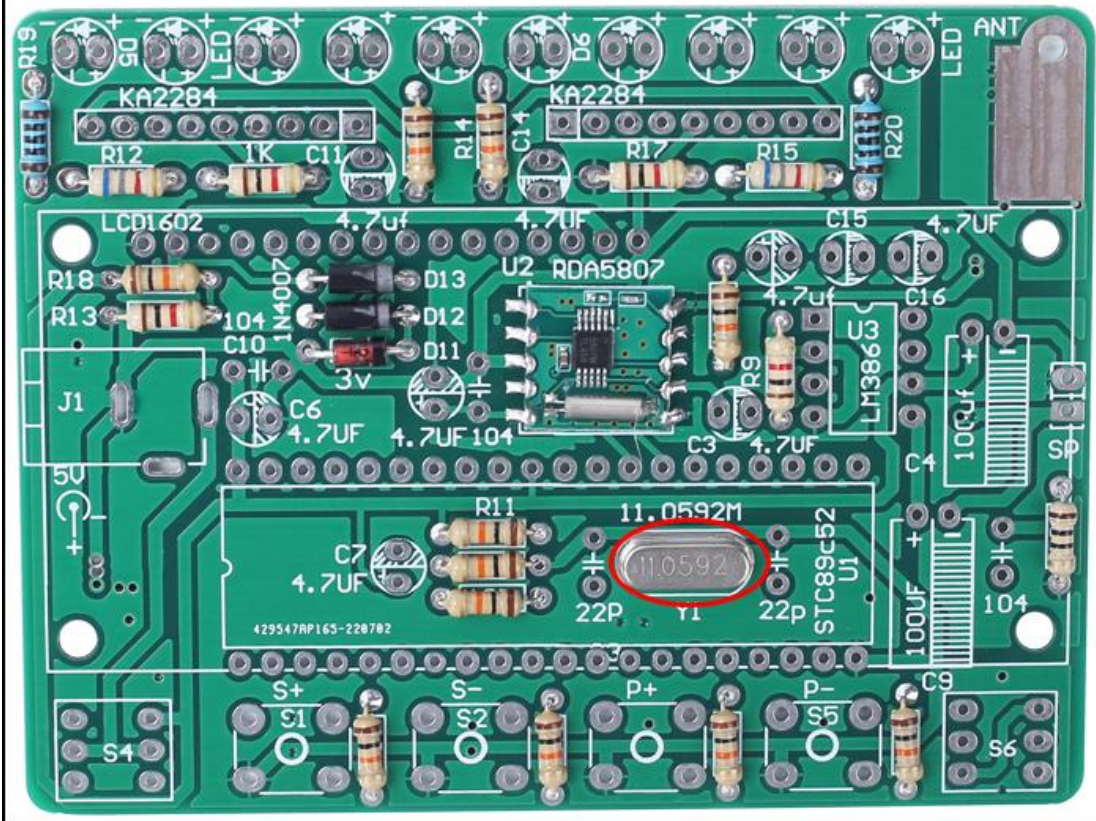

Step 13: Install 1pcs DIP-8 IC Socket at U3. There is a gap mark on one end of the IC Socket and there is a gap mark on PCB silk screen where the IC Socket can place on. These two marks are corresponding to each other and are used to specify the installation direction of the IC Socket.

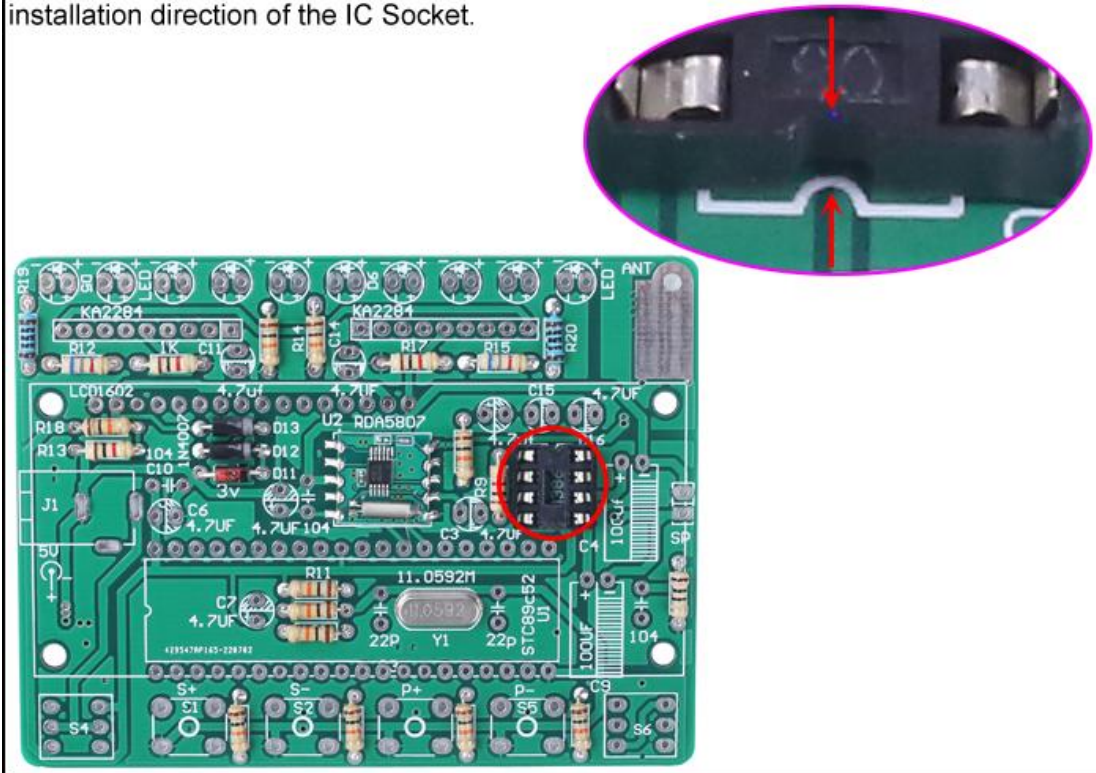

Step 14: Install 1pcs DIP-40 IC Socket at U1. There is a gap mark on one end of the IC Socket and there is a gap mark on PCB silk screen where the IC Socket can place on. These two marks are corresponding to each other and are used to specify the installation direction of the IC Socket.

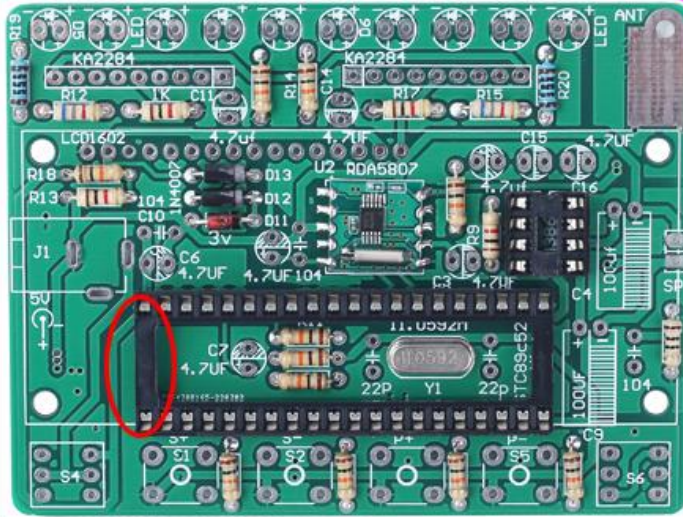
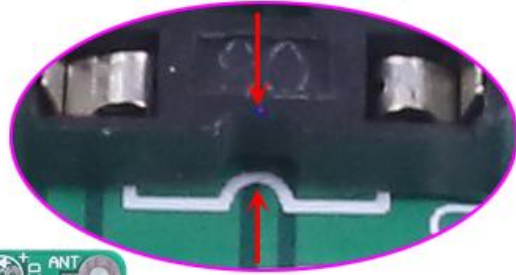

Step 15: Install 2pcs 22pF Ceramic Capacitor at C1,C2.

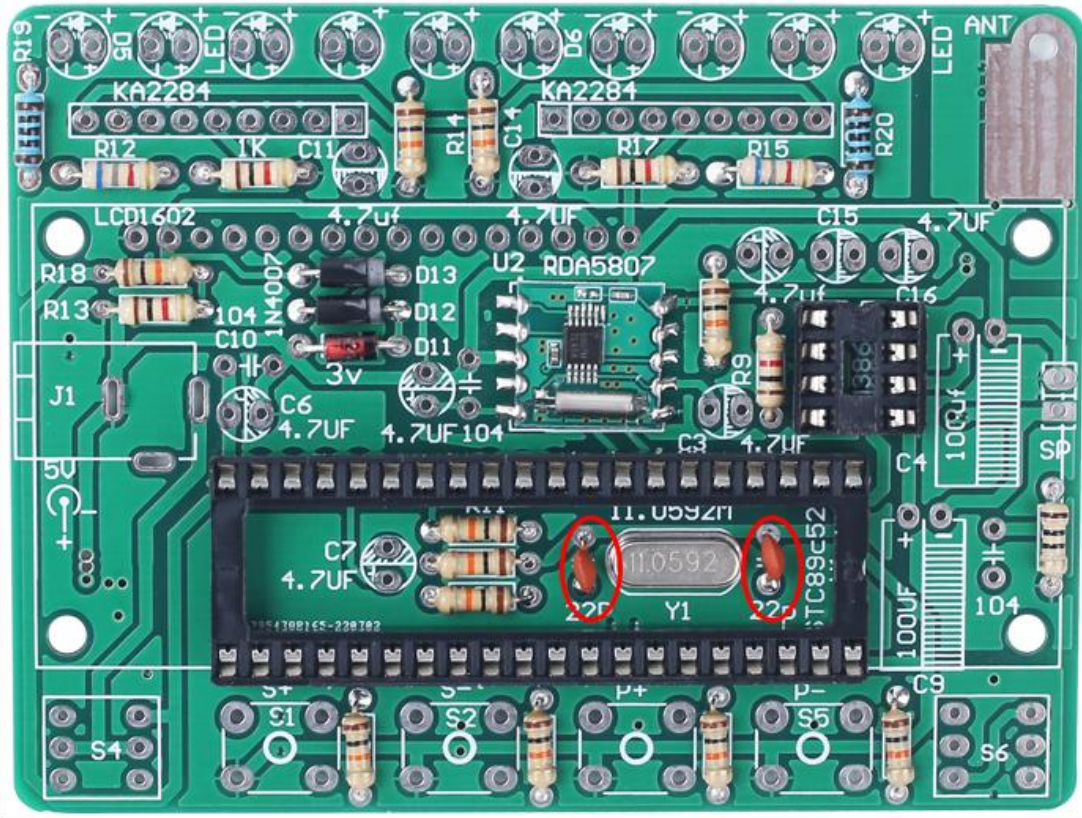

Step 16: Install 3pcs 0.1uF 104 Monolithic Capacitor at C10,C12,C13.

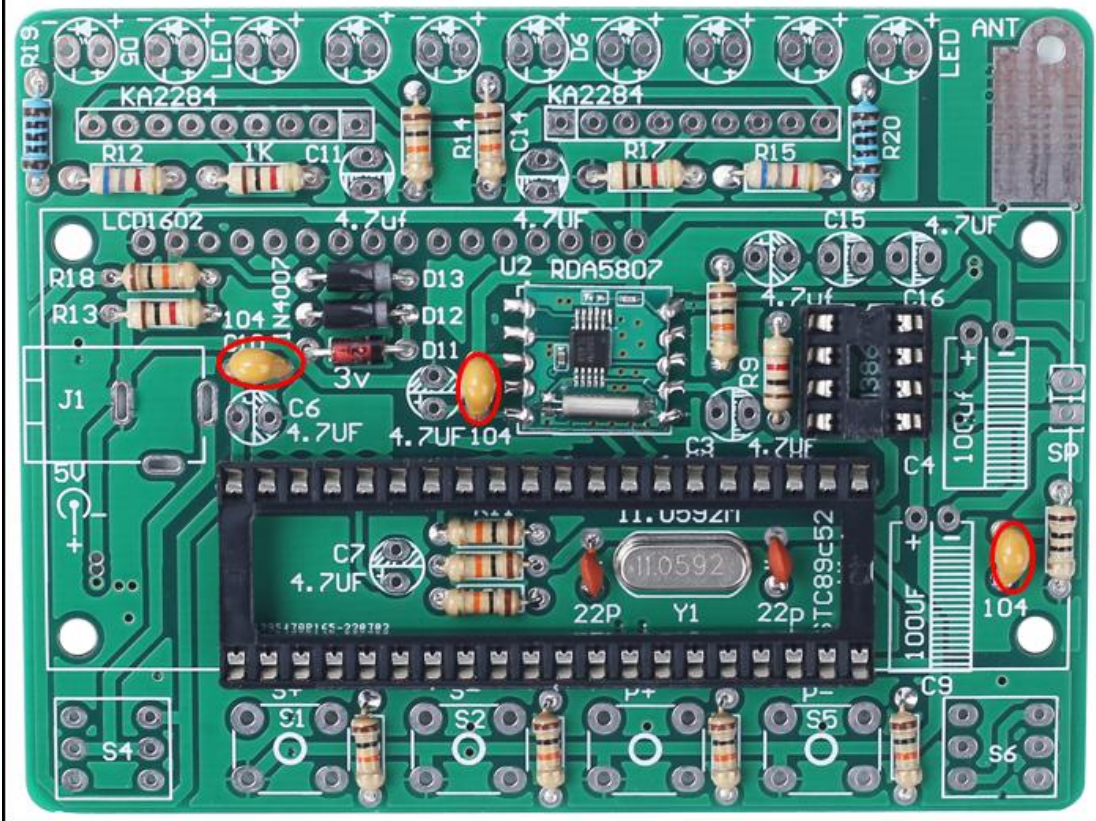

Step 17: Confirm and identify the installation direction of the KA2284.

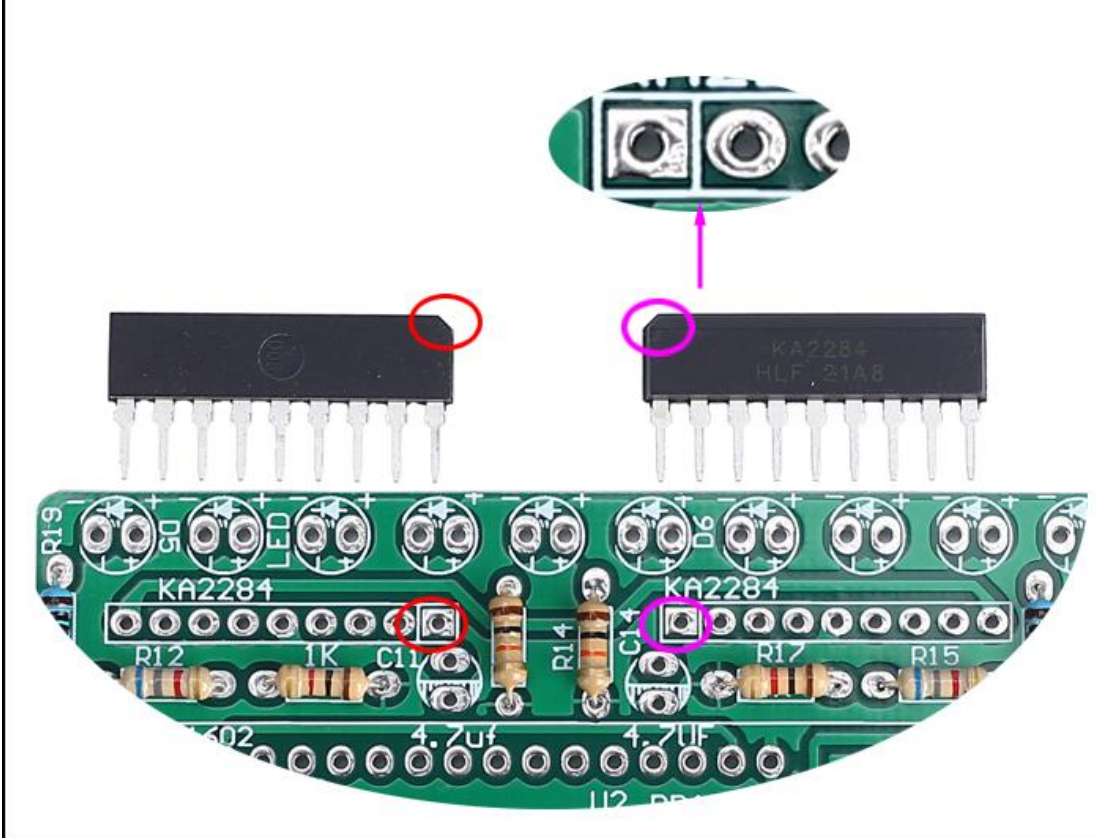

Step 18: Install 2pcs ZIP-9 KA2284 LED Driver at KA2284.

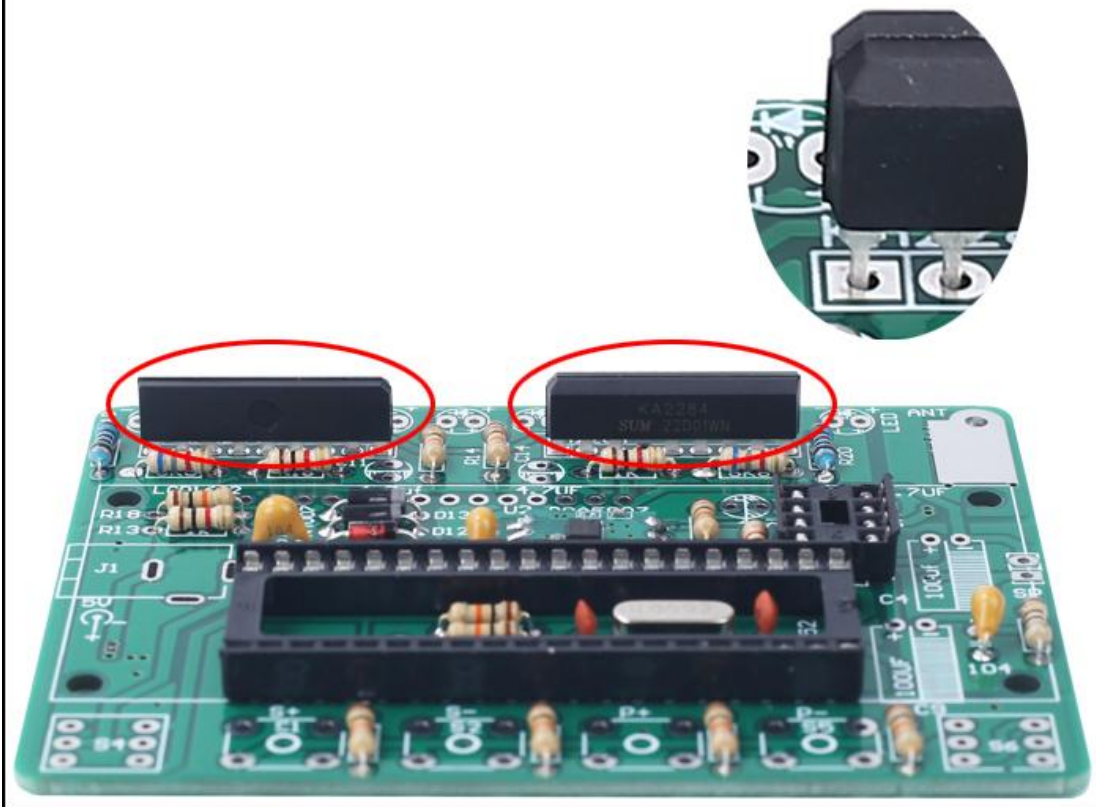

Step 19: Identify the positive(anode) and negative(cathode) lead of LED. The leads of the LED must be installed correctly, otherwise the LED cannot be turned on. Here are four methods as following:

- 19.1>.According to the length of the LED lead to distinguish. The longer pin is positive(anode) lead. The shorter pin is negative(cathode) lead.
- 19.2>.Identify the negative(cathode) of the LED is to look into the plastic case where one can see that the negative(cathode) is much thicker/bigger inside the plastic case than the anode lead.
- 19.3>.Identify by edge of plastic case. The negative(cathode) lead of the LED should be the pin nearest the flat on the plastic case.
- 19.4>.Test by 3V battery or multimeter. The pin is positive(anode) lead which has connect to positive of 3V if LED can light up after connect 3V power supply. (LED can not be powered directly from 3V for a short time:less then 0.5second)
- 19.5>.Note:If the flat on package disagrees with other indicators(short lead,large cathode lead end), then other indicators take priority. I.e. if the flat disagrees with the lead length,use the lead length as the cathode indicator.

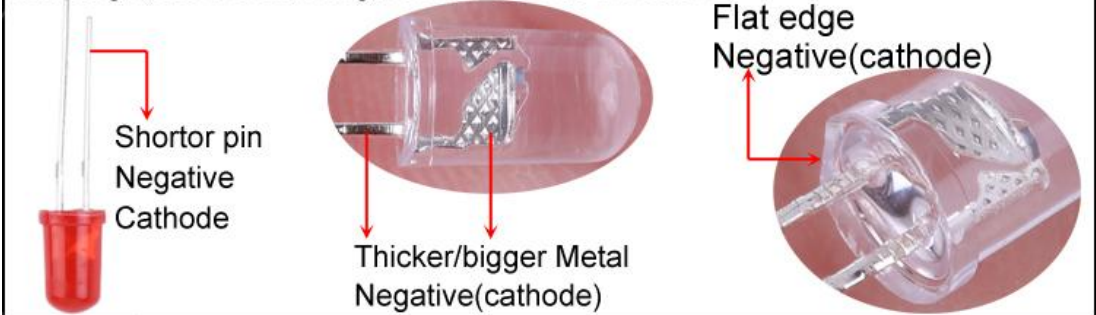

Step 20: Install 10pcs 5mm RGB LED at LED1-LED10.

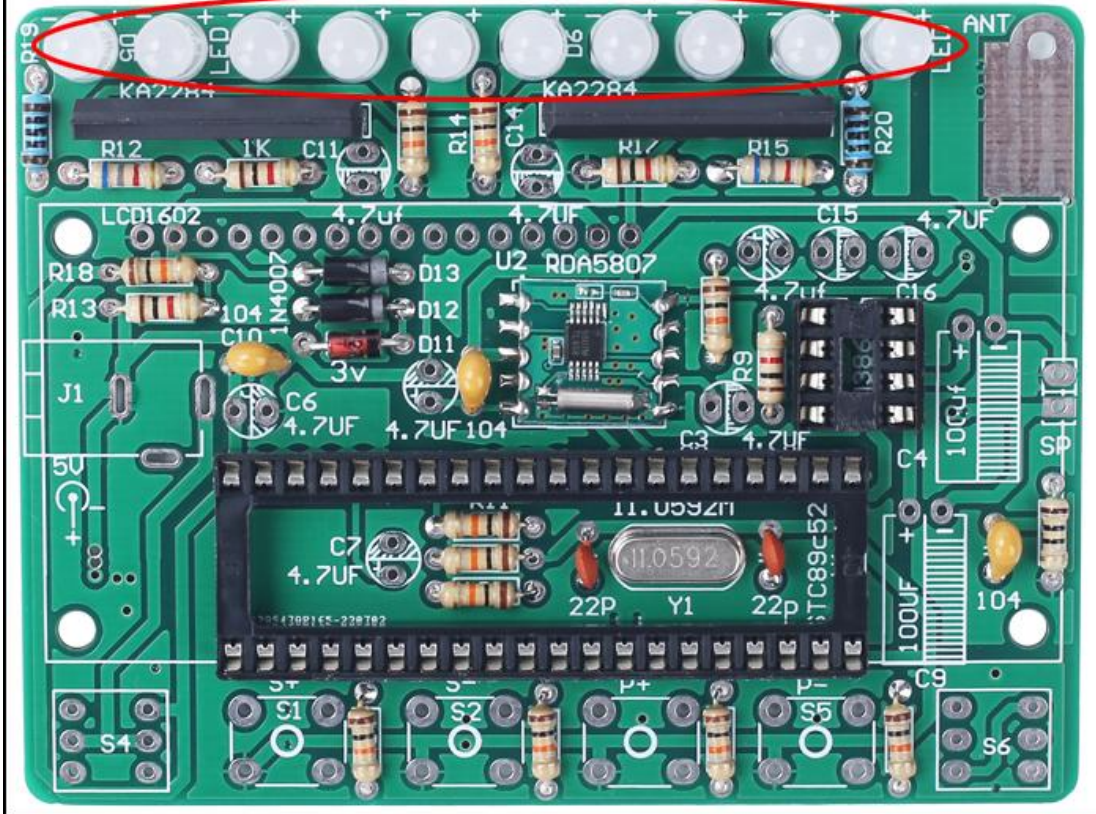

Step 21: Install 1pcs 16Pin DuPont Female Socket at LCD1602.

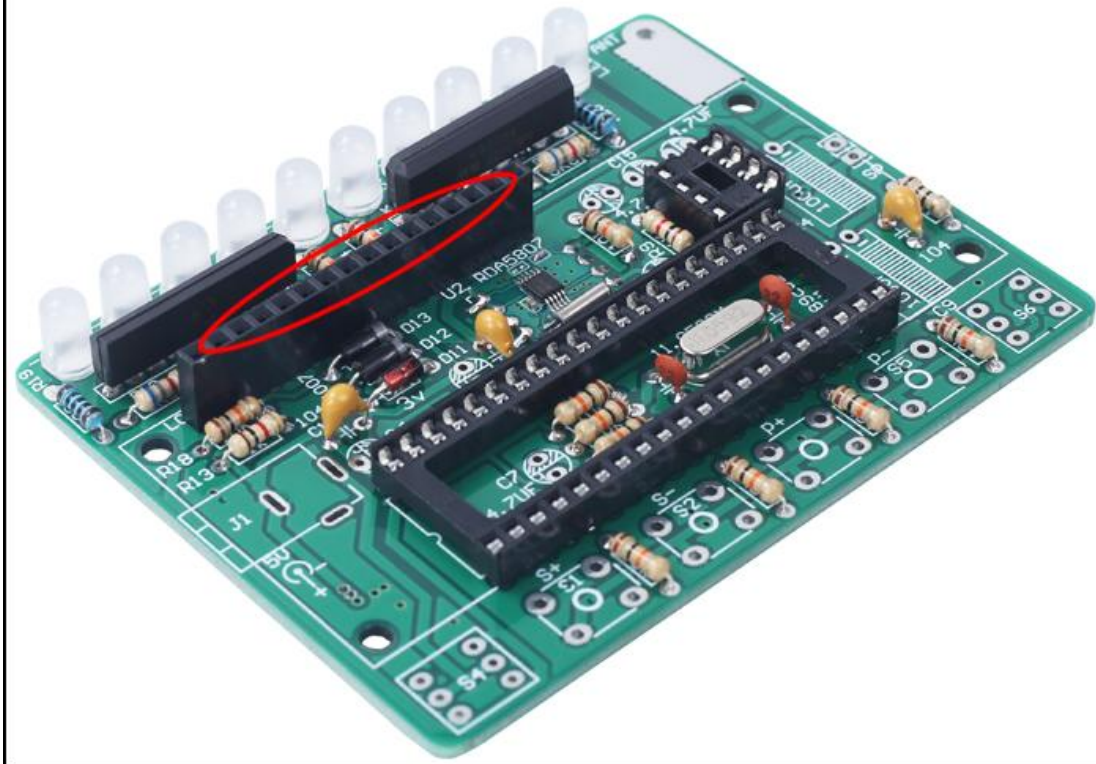

Step 22: Bend the pins of only one 4.7uF electrolytic capacitor about 2mm.
Note: Just for only **one**!



Step 23: Install **this** Electrolytic Capacitor at C7.
Pay attention to distinguish between positive and negative. The Longer pin is positive pole. Note: The capacitor needs to be placed horizontally. Otherwise, the following components cannot be installed.

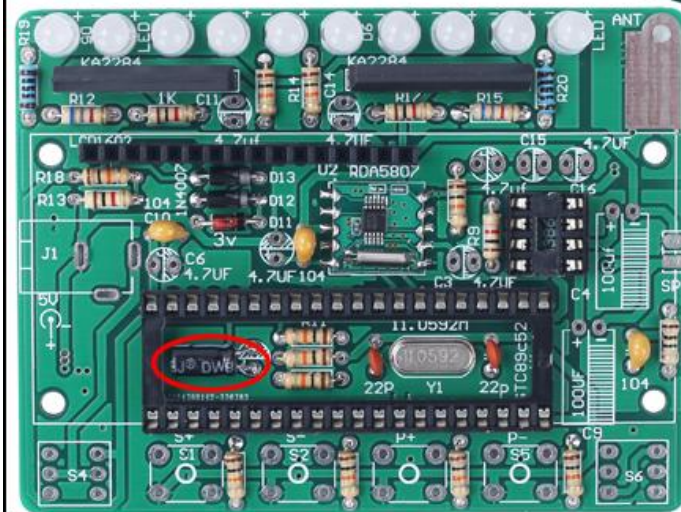

Step 24: Install others 8pcs 4.7uF Electrolytic Capacitor at C3, C5, C6, C8, C11, C14, C15, C16 .Pay attention to distinguish between positive and negative. The Longer pin is positive pole. Note: The capacitor needs to be placed horizontally, keep a distance of 2mm between the capacitor and the PCB when installing.

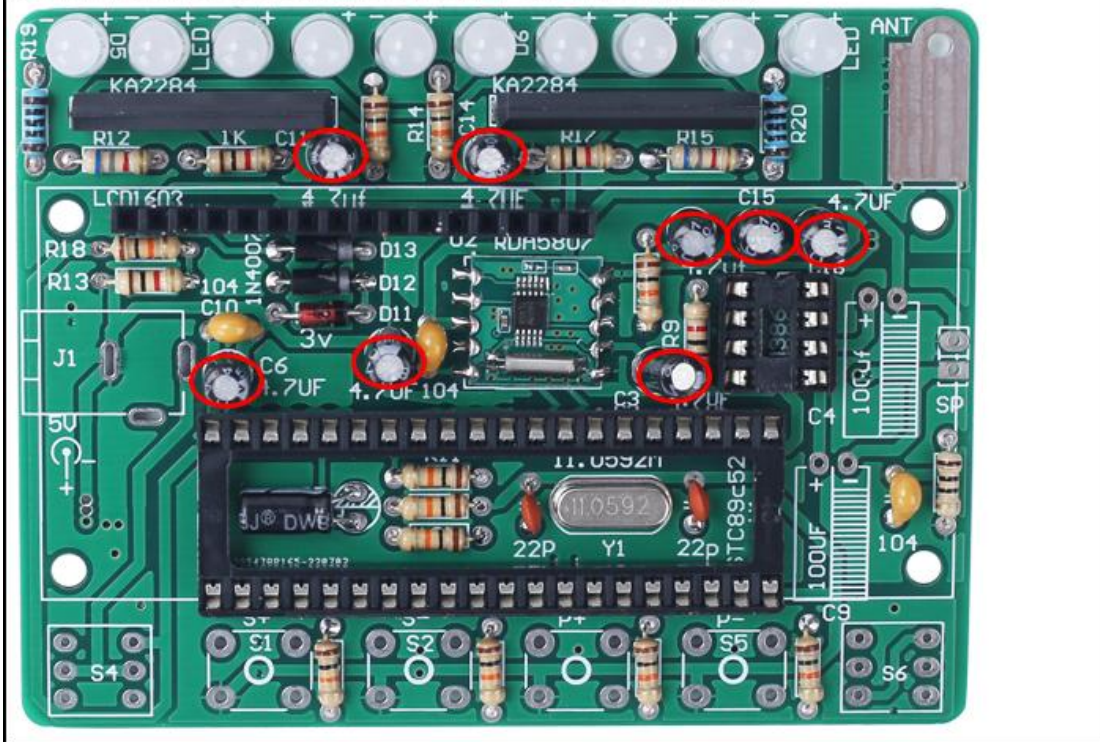

Step 25: Install 2pcs 100uF Electrolytic Capacitor at C4,C9.Pay attention to distinguish between positive and negative. The Longer pin is positive pole. Note: The capacitor needs to be placed horizontally, keep a distance of 2mm between the capacitor and the PCB when installing.

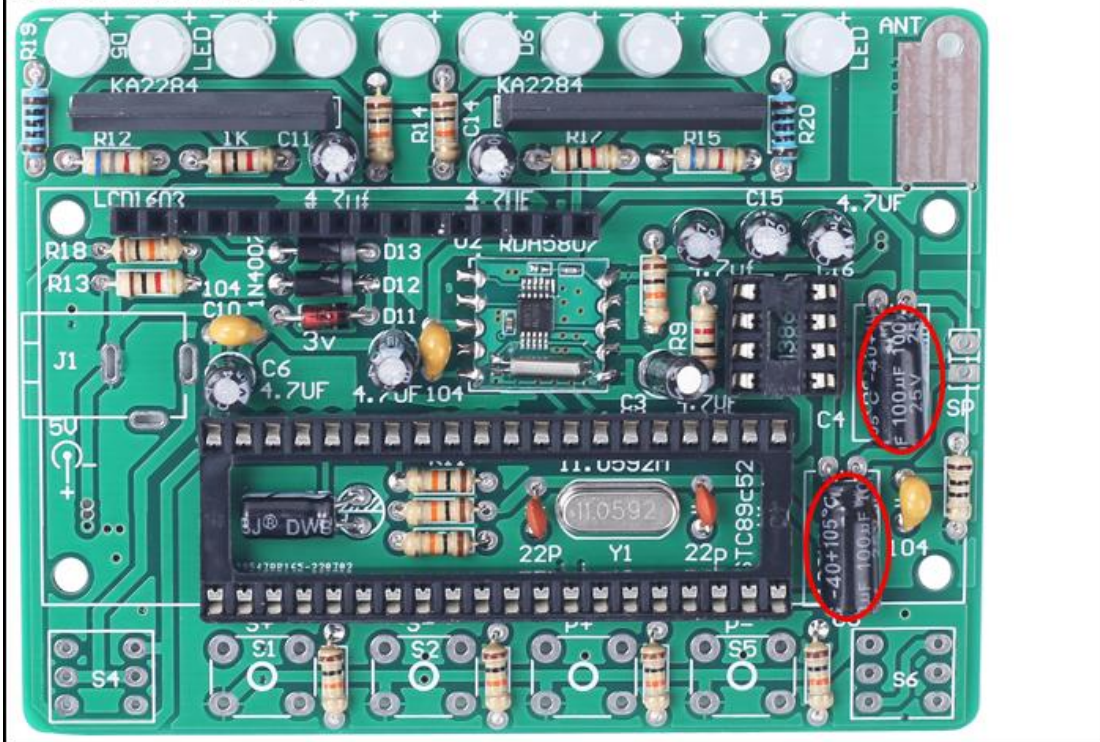

Step 26: Install 1pcs DC-005 Power Socket at J1.

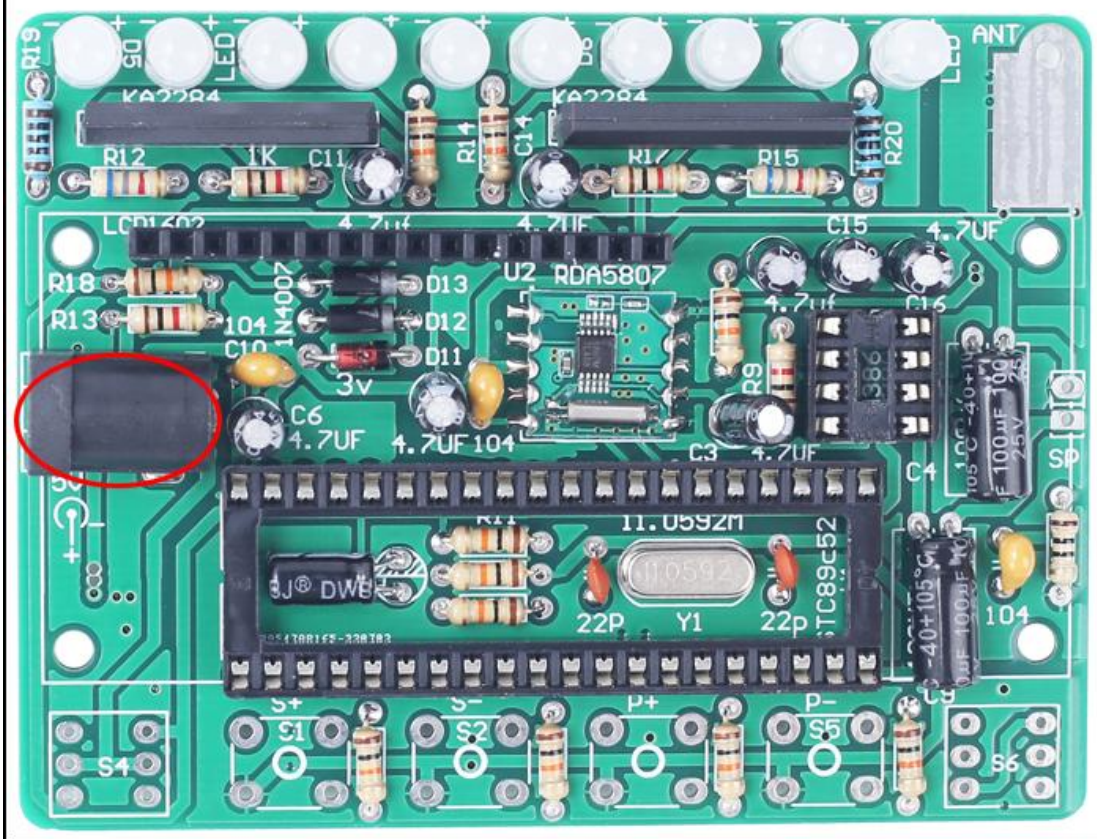

Step 27: Install 2pcs 5.8*5.8mm Self-locking Button at S4,S6.

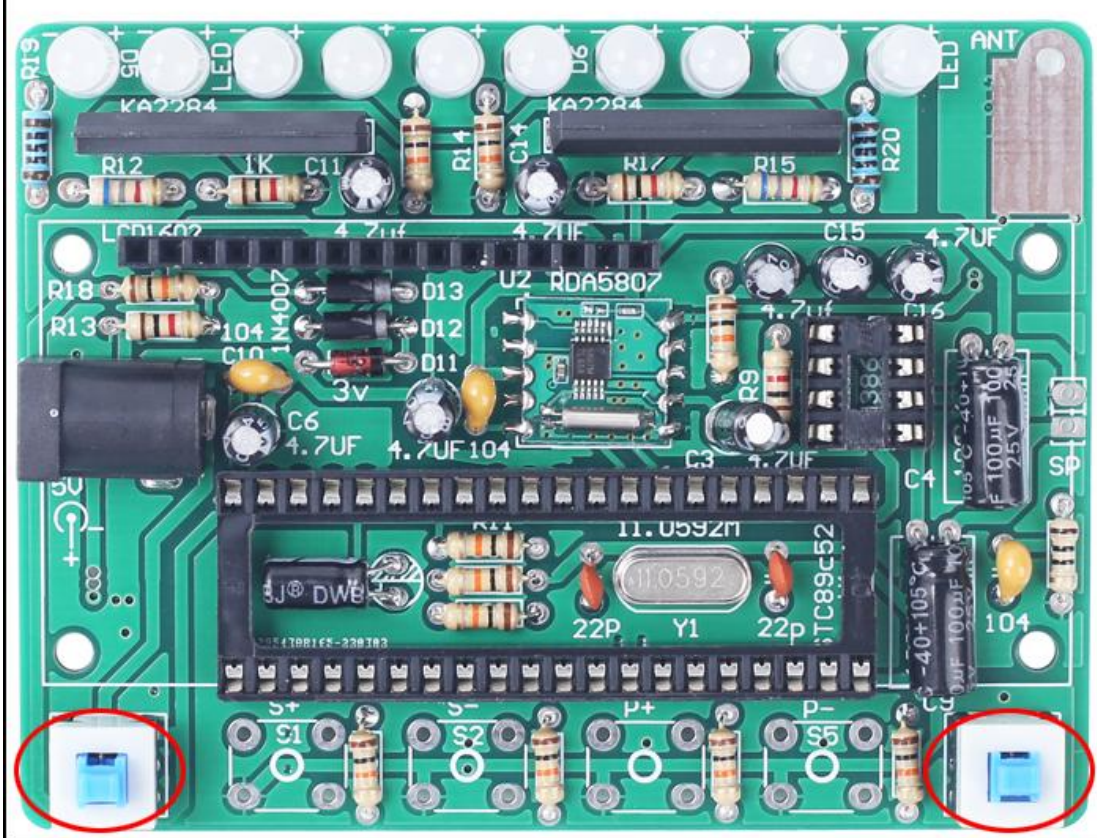

Step 28: Install 4pcs 6*6*20mm Black Button at S1,S2,S3,S5.

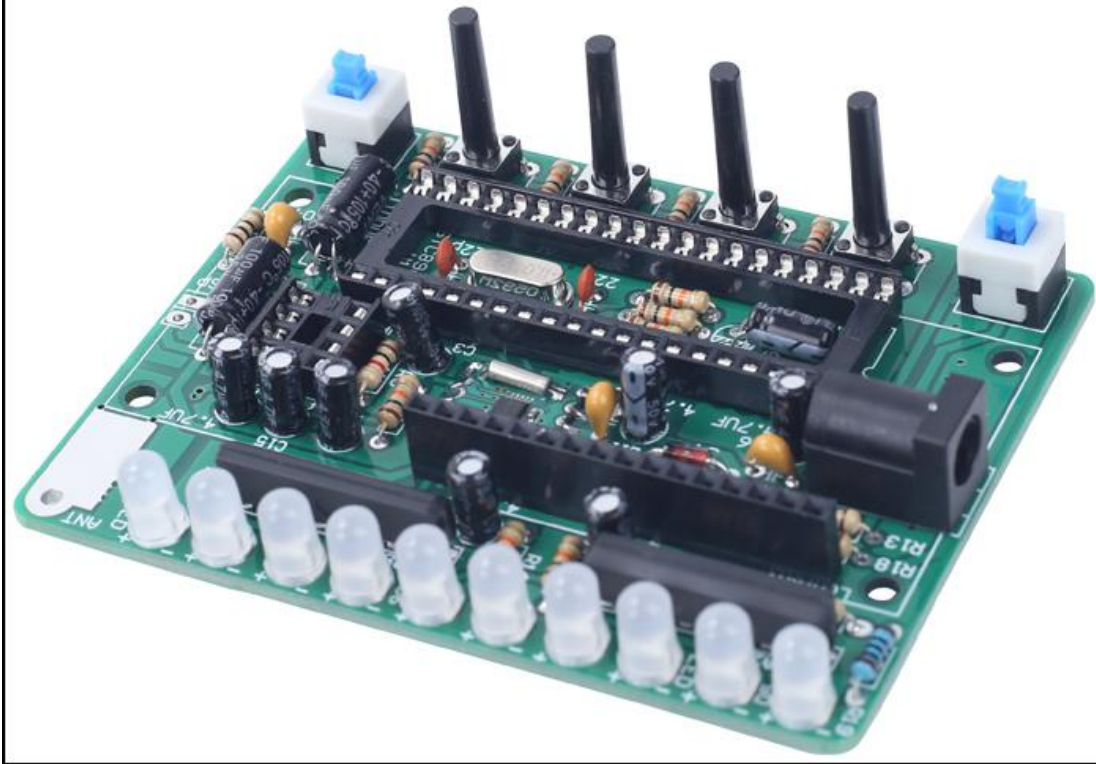

Step 29: Install 1pcs DIP-8 IC LM386N at U3. There is a gap mark on one end of the IC and there is a gap mark on DIP-8 IC Socket where the IC can place on. These two marks are corresponding to each other and are used to specify the installation direction of the IC.

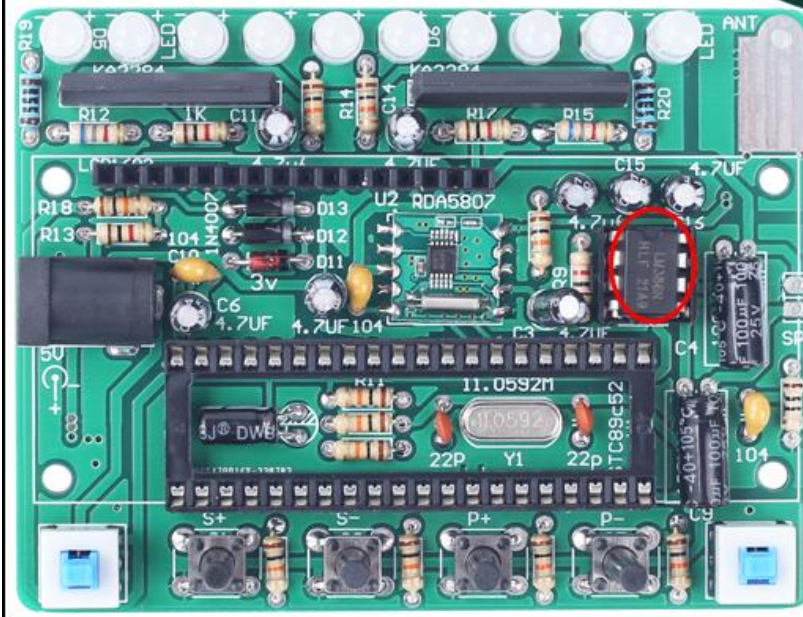
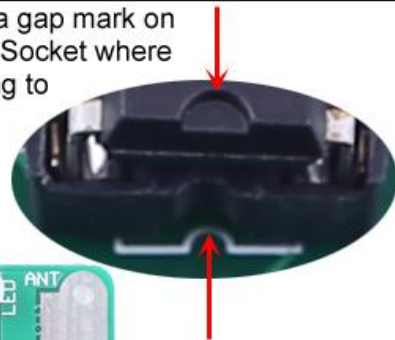

Step 30: Install 1pcs DIP-40 IC STC89C52RC. There is a gap mark on one end of the IC and there is a gap mark on DIP-40 IC Socket where the IC can place on. These two marks are corresponding to each other and are used to specify the installation direction of the IC.

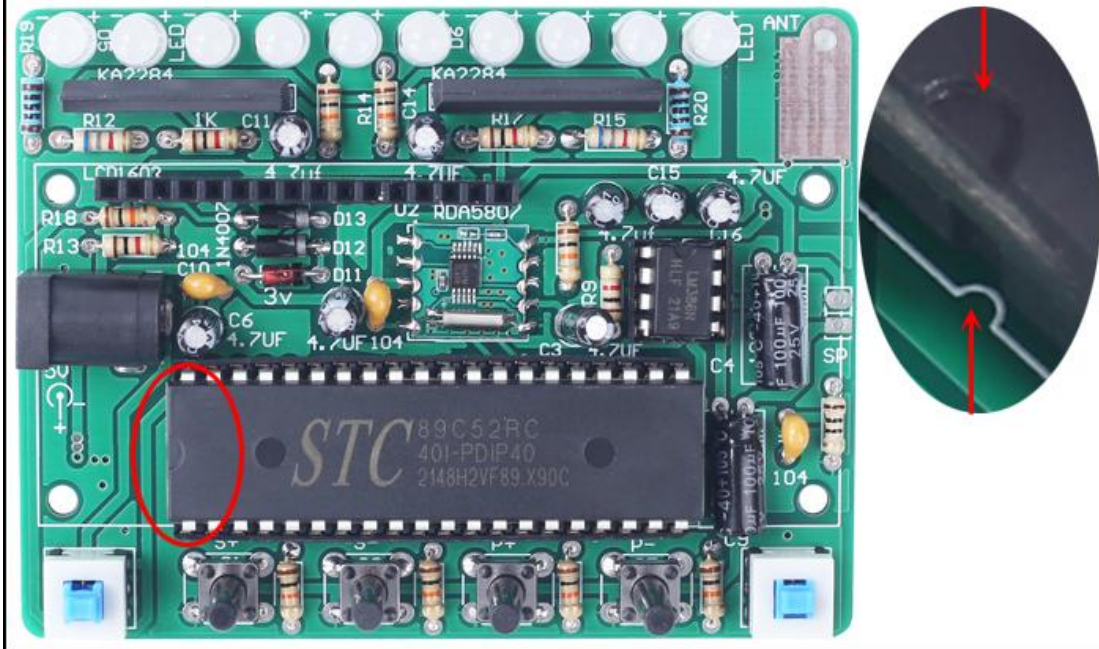

Step 31: Fix 4pcs M3*10mm Copper Pillar and 4pcs M3*8mm Screw on PCB.

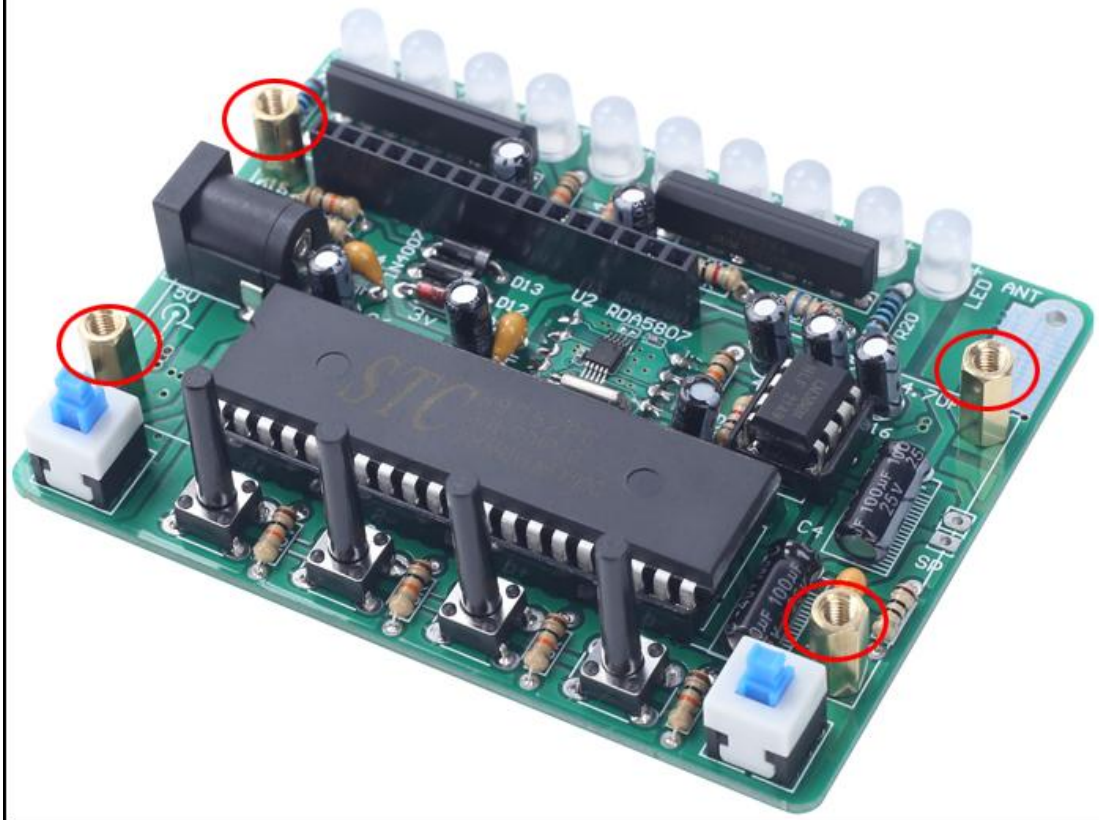

Step 32: Install 1pcs 16Pin Male Socket on the back of LCD1602 display screen.
 Note the black plastic block on the back of the LCD. Please cut off the extra pins with scissors and reserve the 16pin, if you get 20pin or 22pin or other.

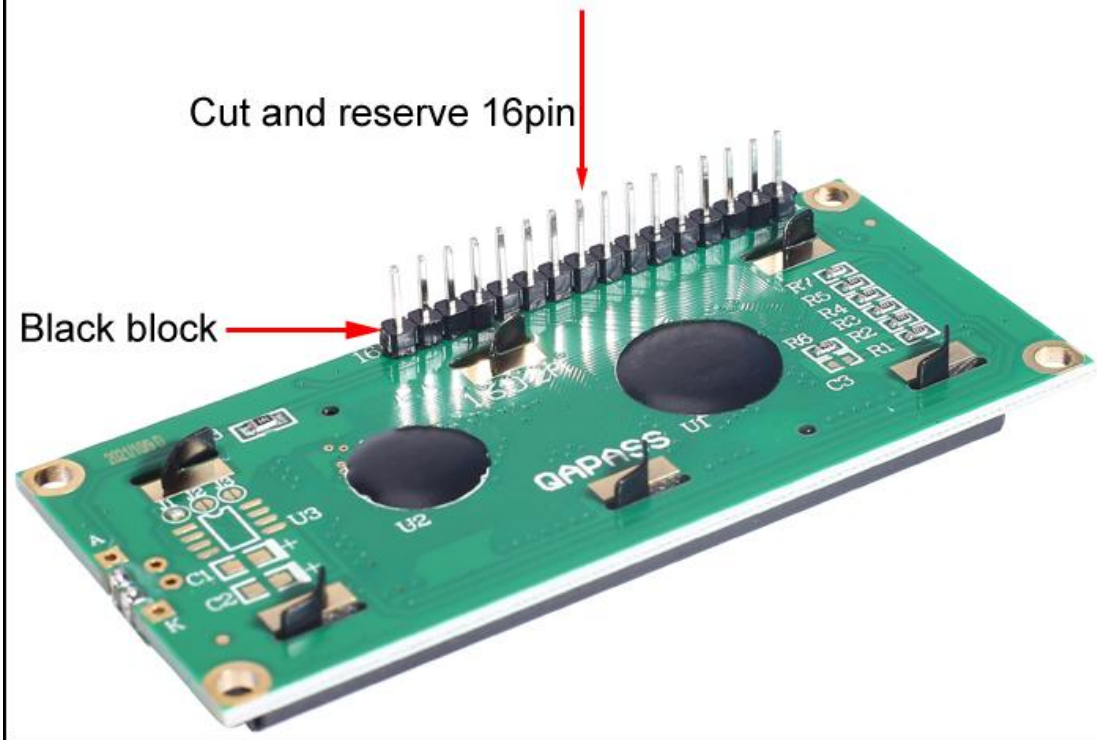

Step 33: Plug LCD1602 display screen on 16Pin DuPont Female Socket.
 Note: Don't use screws to fix it for now.

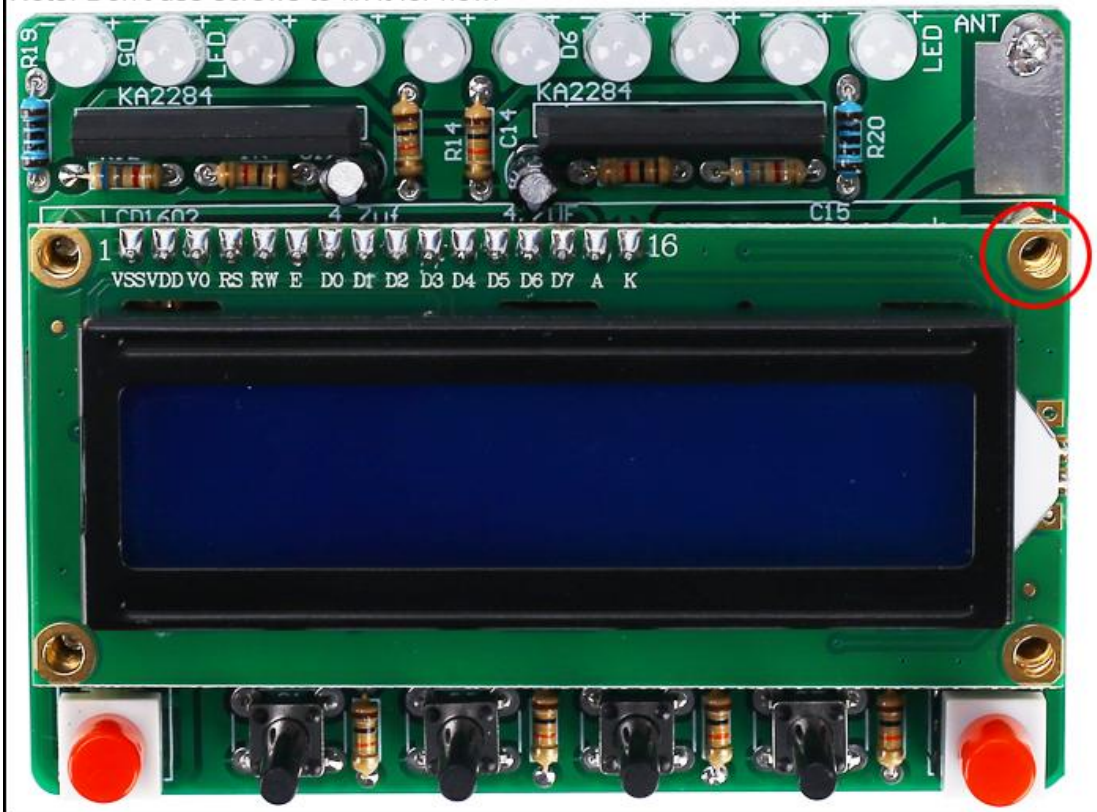

Step 34: Install 1pcs 75ohm Antenna at ANT. Keep a distance more than 5mm from PCB and fix by tin(not screw). Note that the antenna should be installed on the back of the PCB.

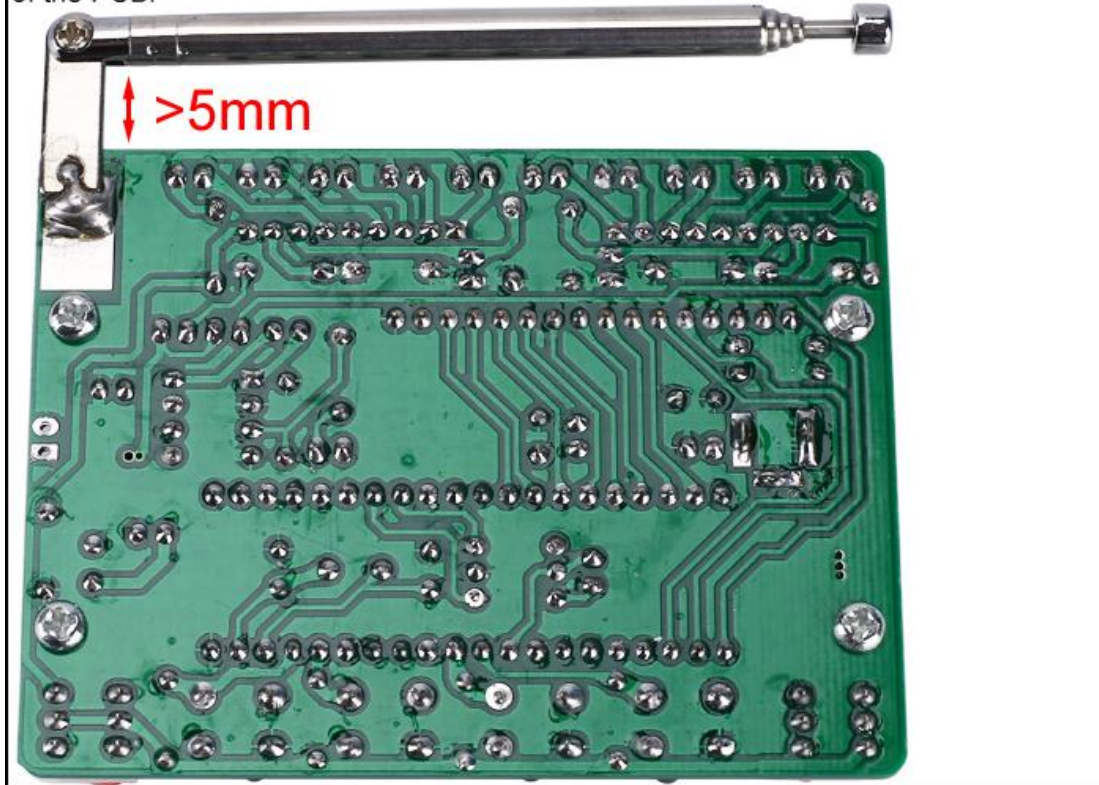

Step 35: Place 2pcs red button cap on Self-locking Button.



Step 36: Connect speaker to PCB at SP by 20cm red/black Cable. The speaker does not distinguish between positive and negative.

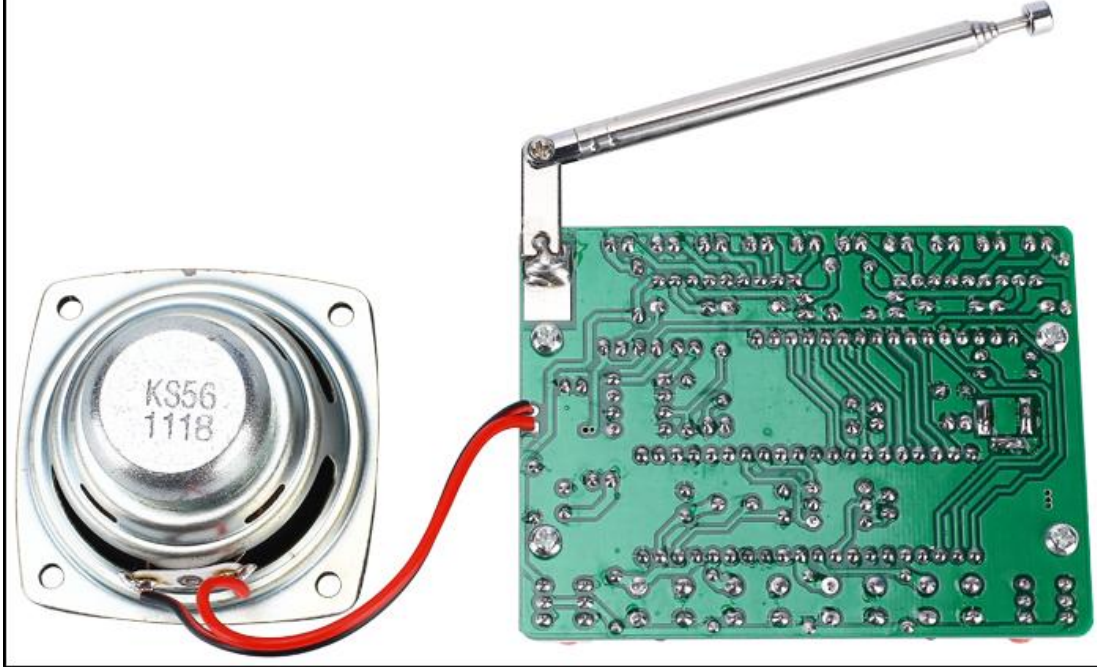

Step 37: Tear off the protective film on the surface of the acrylic shell.



Step 38: Fix Top Acrylic Board and LCD1602 Acrylic Board on Copper Pillar by 4pcs M3*6mm Screw.

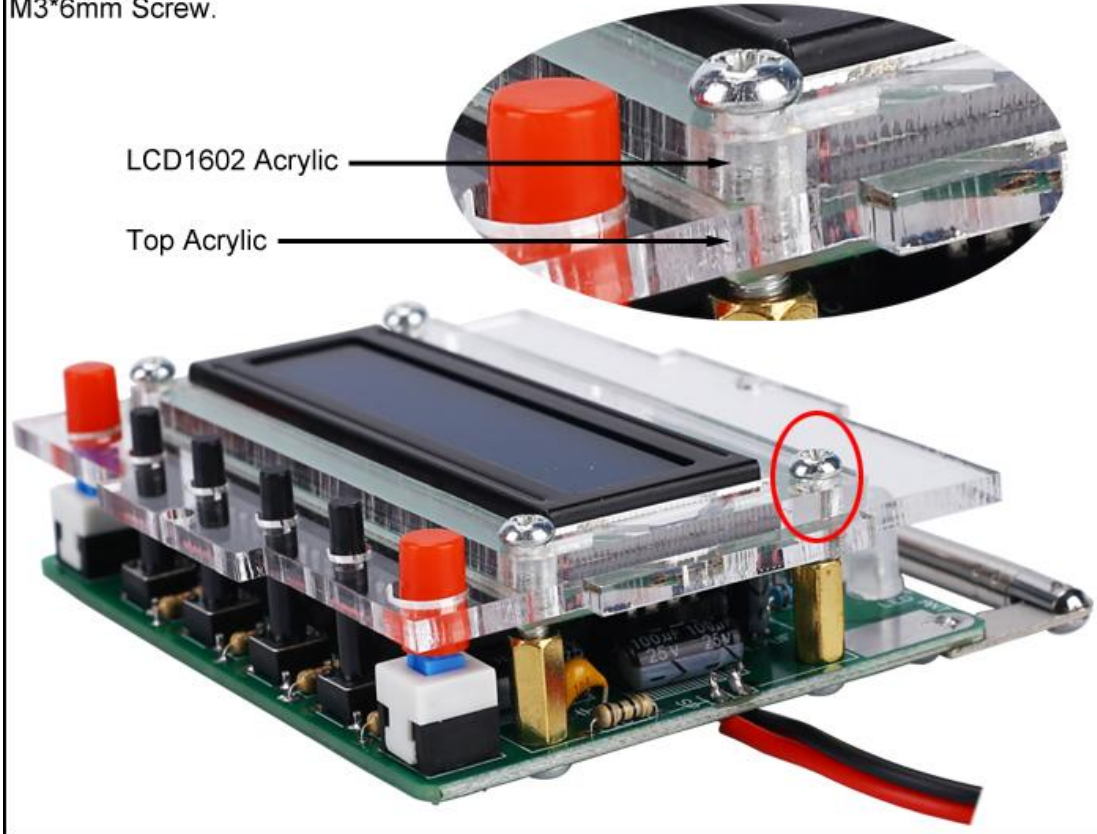

Step 39: Fix 4pcs Side Acrylic Board by 6pcs M3*6mm Screw and 6pcs M3 Nuts.

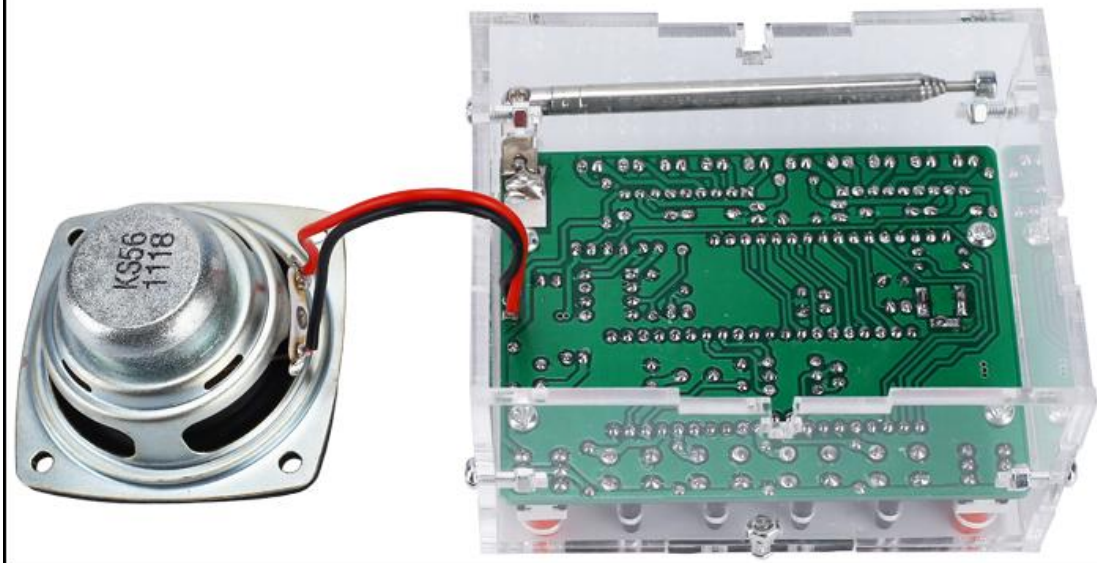

Step 40: Fix speaker on Acrylic Bottom Board by 4pcs M3*10mm Screws and 4pcs M3 Nuts.



Step 41: Install Speaker Acrylic Board by 4pcs M3*6mm Screw and 4pcs M3 Nuts.



Step 42: Connect to power supply and enjoy the effect.

