

(BBAC)
breadboard arduino
compatible

Breadboard Arduino Compatible Assembly Guide

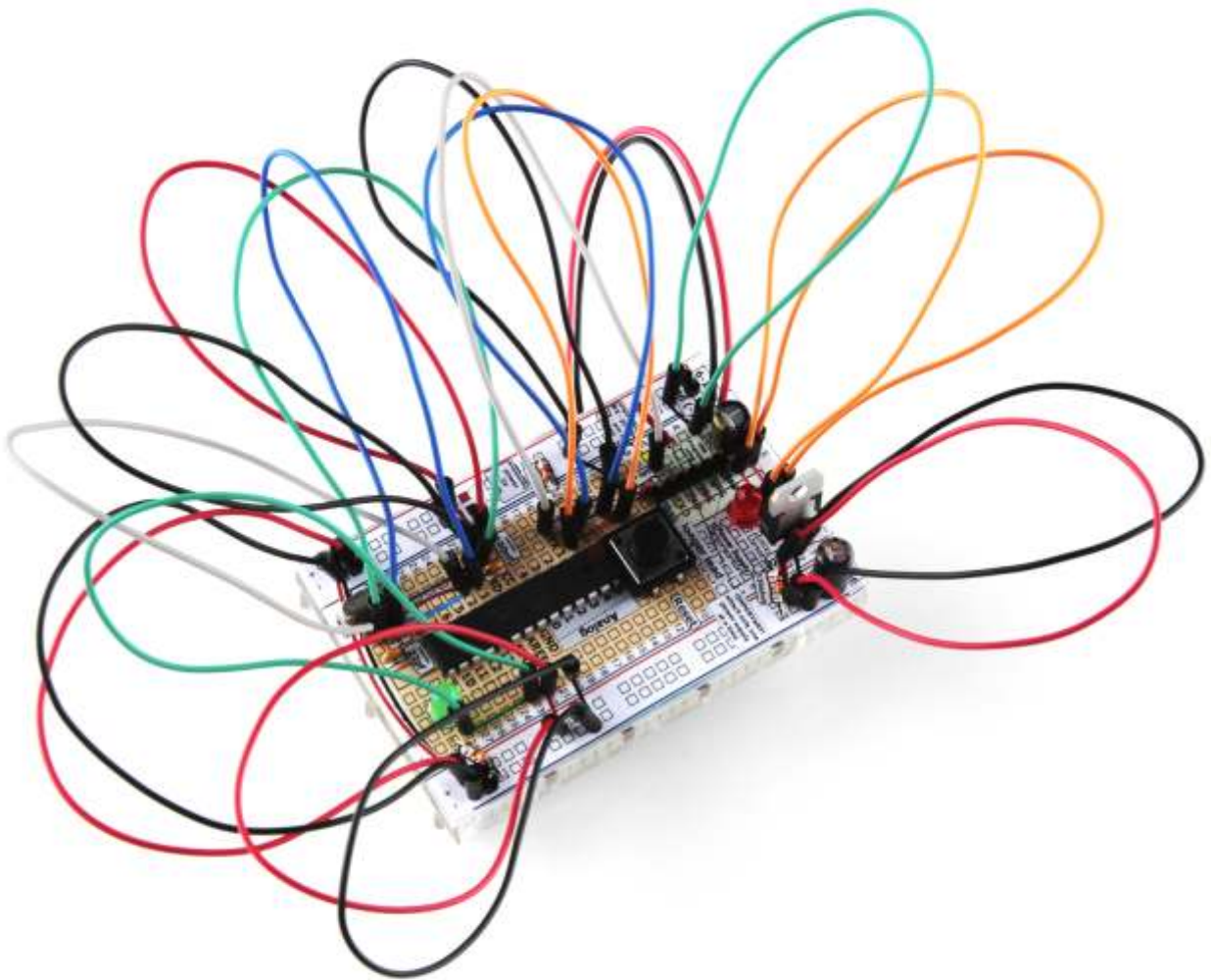

(BBAC)

sparkfun.com

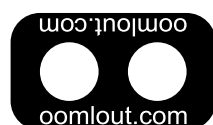

A Few Words

ABOUT THIS KIT

The overall goal of this kit is fun. Beyond this, the aim is to get you comfortable using a wide range of electronic components through small, easy circuits. The focus is to get each circuit working then give you the tools to figure out why. If you encounter any problems, want to ask a question, or would like to know more about any part, extra help is only an e-mail away help@oomlout.com.



ABOUT OPEN SOURCE HARDWARE

All of the projects at SparkFun and .:oomlout:. are open source. What does this mean? It means everything involved in making this kit, be it this guide, 3D models, or code, is available for free download. But it goes further, you're also free to reproduce and modify any of this material, then distribute it for yourself. The catch? Quite simple; it is released under a Creative Commons (By - Share Alike) license. This means you must credit .:oomlout:. in your design and share your developments in a similar manner. Why? We grew up learning and playing with open source software and the experience was good fun, we think it would be lovely if a similar experience was possible with physical things.

More details on the Creative Commons CC (By - Share Alike) License can be found at <http://ardx.org/CCLI>

ABOUT .: OOMLOUT :.

We're a plucky little design company focusing on producing
"delightfully fun open source products"

To check out what we are up to

<http://www.oomlout.com>

ABOUT SPARKFUN

SparkFun is an energetic young company seeking to make electronics fun, accessible, and approachable to everyone - from kids in elementary school to PhD-toting engineers.

<http://www.sparkfun.com/>

ABOUT PROBLEMS

We strive to deliver the highest level of quality in each and every thing we produce. If you ever find an ambiguous instruction, a missing piece, or would just like to ask a question, we'll try our best to help out.

help@oomlout.com

(we like hearing about problems it helps us improve future versions)

**Thanks For Choosing .:oomlout:.
and SparkFun**

.: Where to Find Everything :.

{PART}	Required Parts	02
{COMP}	Comparing a BBAC to a Duemilanove	03
{SCHEM}	BBAC Schematic	04
{ASEM}	Assembly Instructions	05
{PROG}	Programming Instructions	08
{NOTE}	Room to Take Notes	09

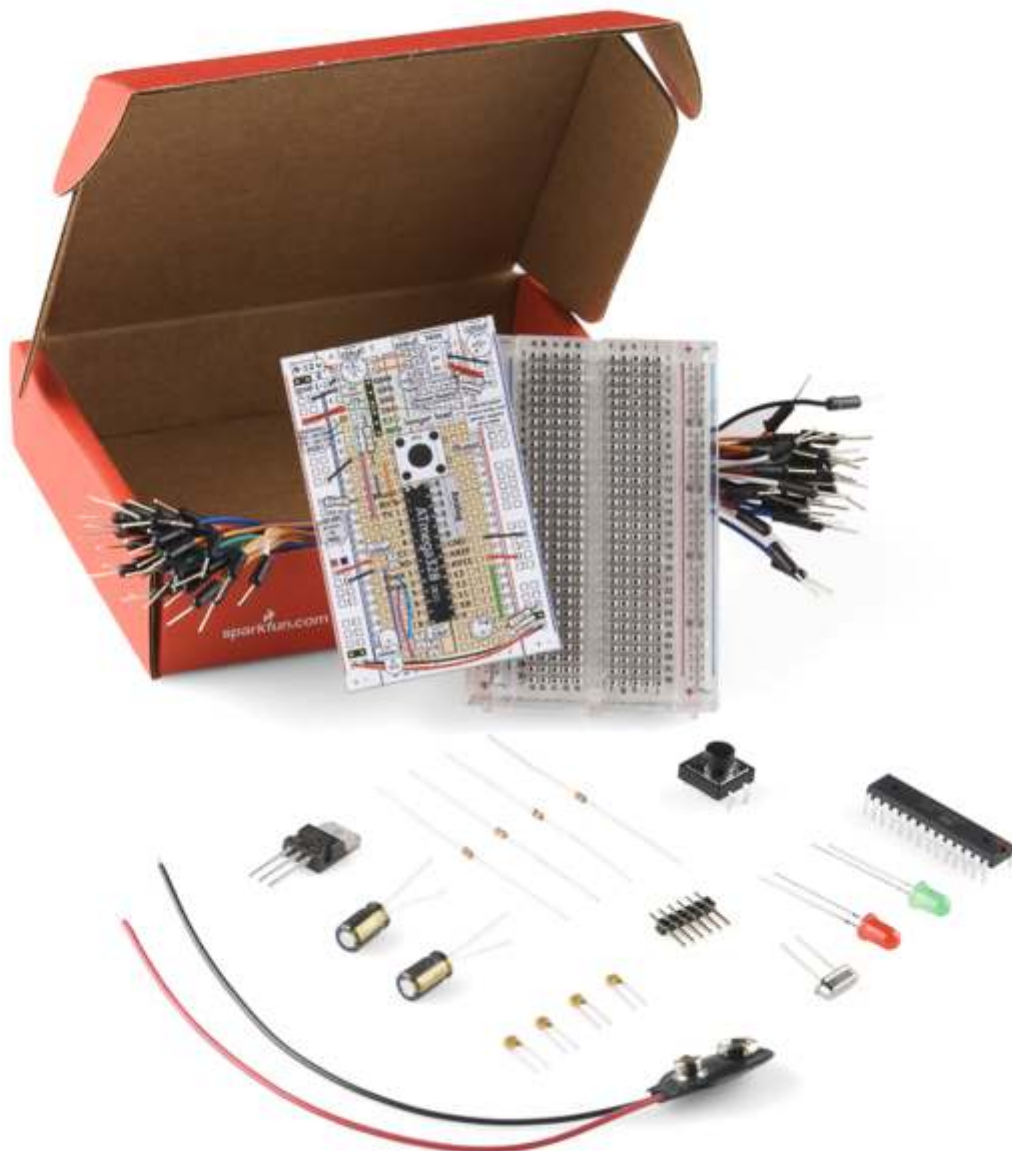



01 PART

the parts

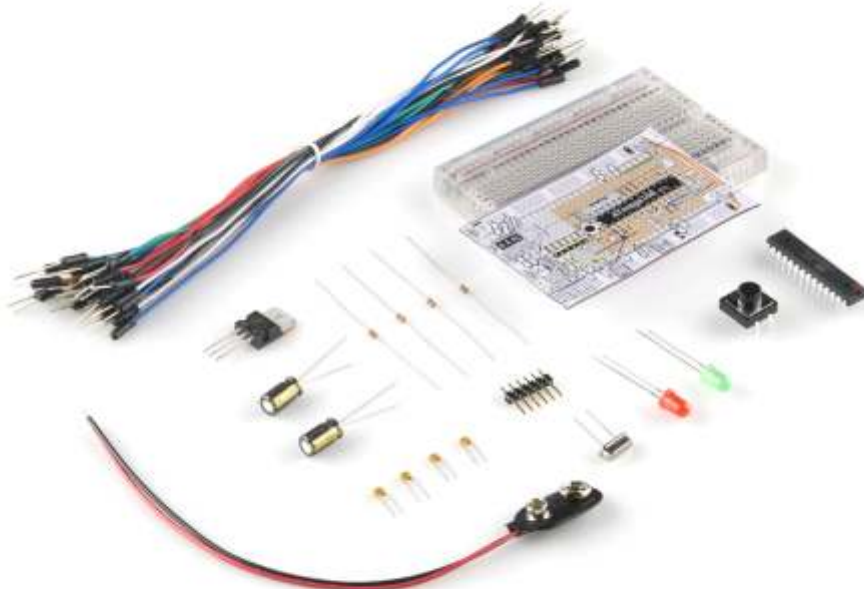

:: The Parts Needed for a :: :: Breadboard Arduino Compatible::





Capacitors

-  **100 uf** - filters the power supply
-  **100 nf** - bypass capacitor (104)
-  **22 pf** - filters the crystal (220)

Resistors

-  **330 ohm** (orange-orange-brown)
LED current limiting
-  **10k ohm** (brown-black-orange)
Pull-ups

Headers

-  **6 Pin** - used for programming with an FTDI cable
-  **2 Pin** - used to pin down the breadboard layout sheet.

Battery Clip - (9v)

-  For powering the board with a 9v battery

Breadboard

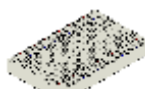
-  Allows for easy assembly of circuits without soldering

Crystal - (16 MHz)

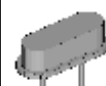
-  Provides a clock signal for the ATmega chip

Breadboard Layout Sheet

-  Place on top of a breadboard to show where components go

Microcontroller - (ATMega328)

-  A single chip computer that runs your code

Pushbutton - (Reset)

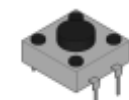
-  Resets the micro-controller when pressed

Voltage Regulator - (7805)

-  Takes in 7-12 volts and outputs 5 volts

LEDs- (Light Emitting Diodes)

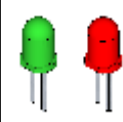
-  Used as indicators
Red - power
Green - connected to pin 13

∴ An Arduino Uno∴

&

∴ Breadboard Arduino Compared∴

02 COMP
comparison

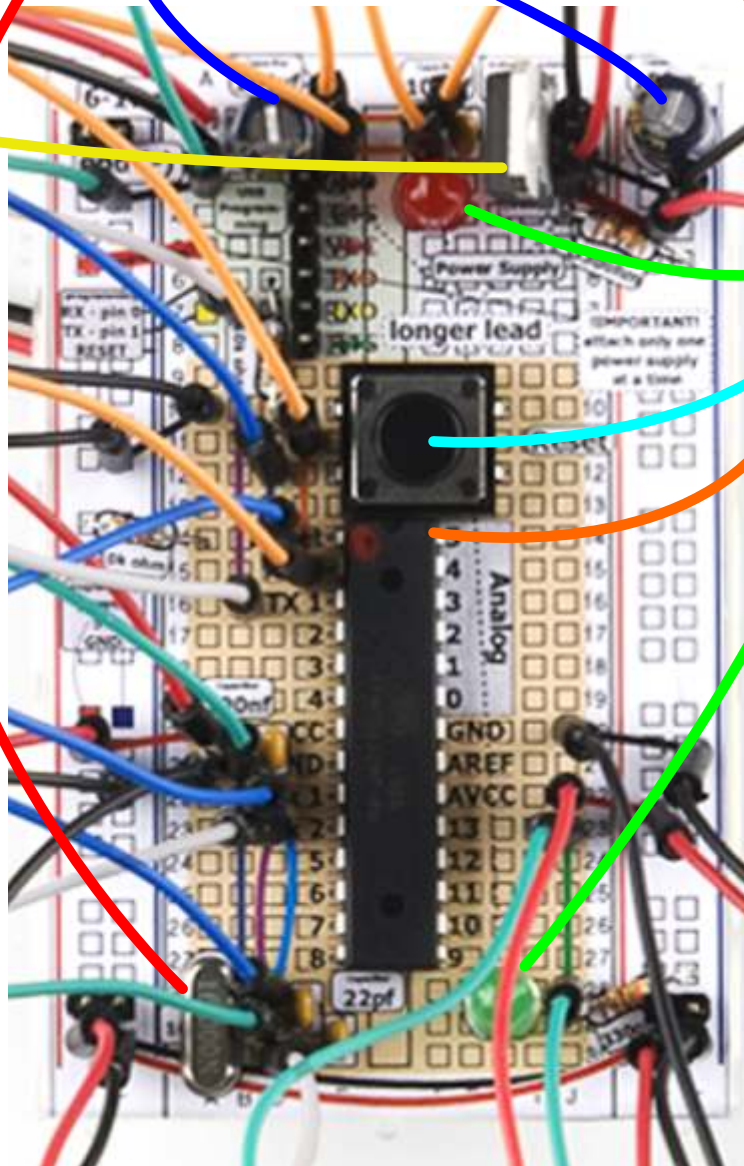
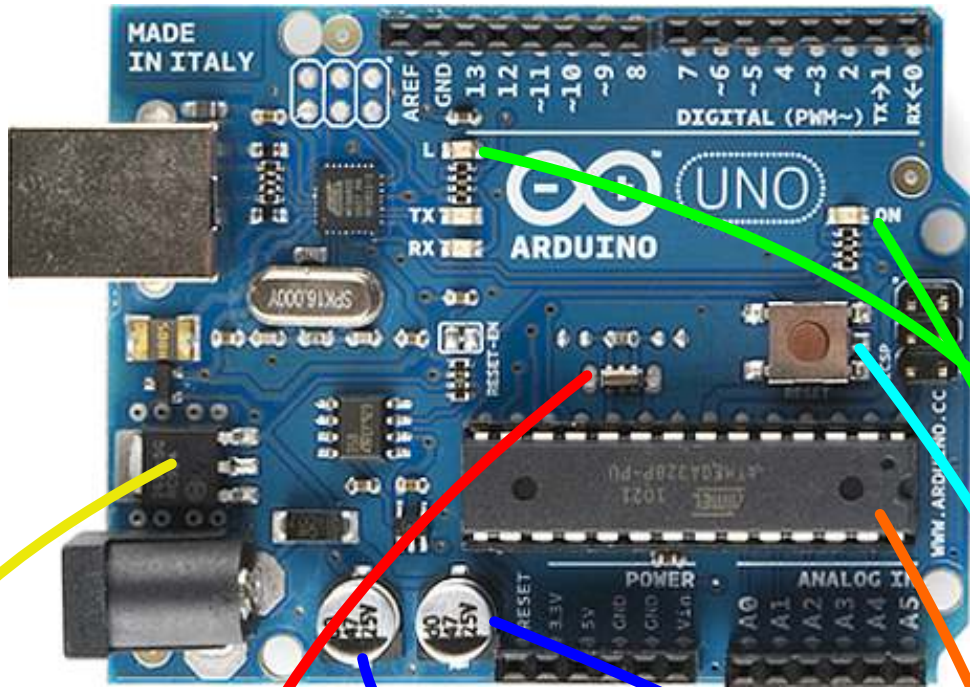

:: Breadboard Arduino Compatible: ::Schematic::

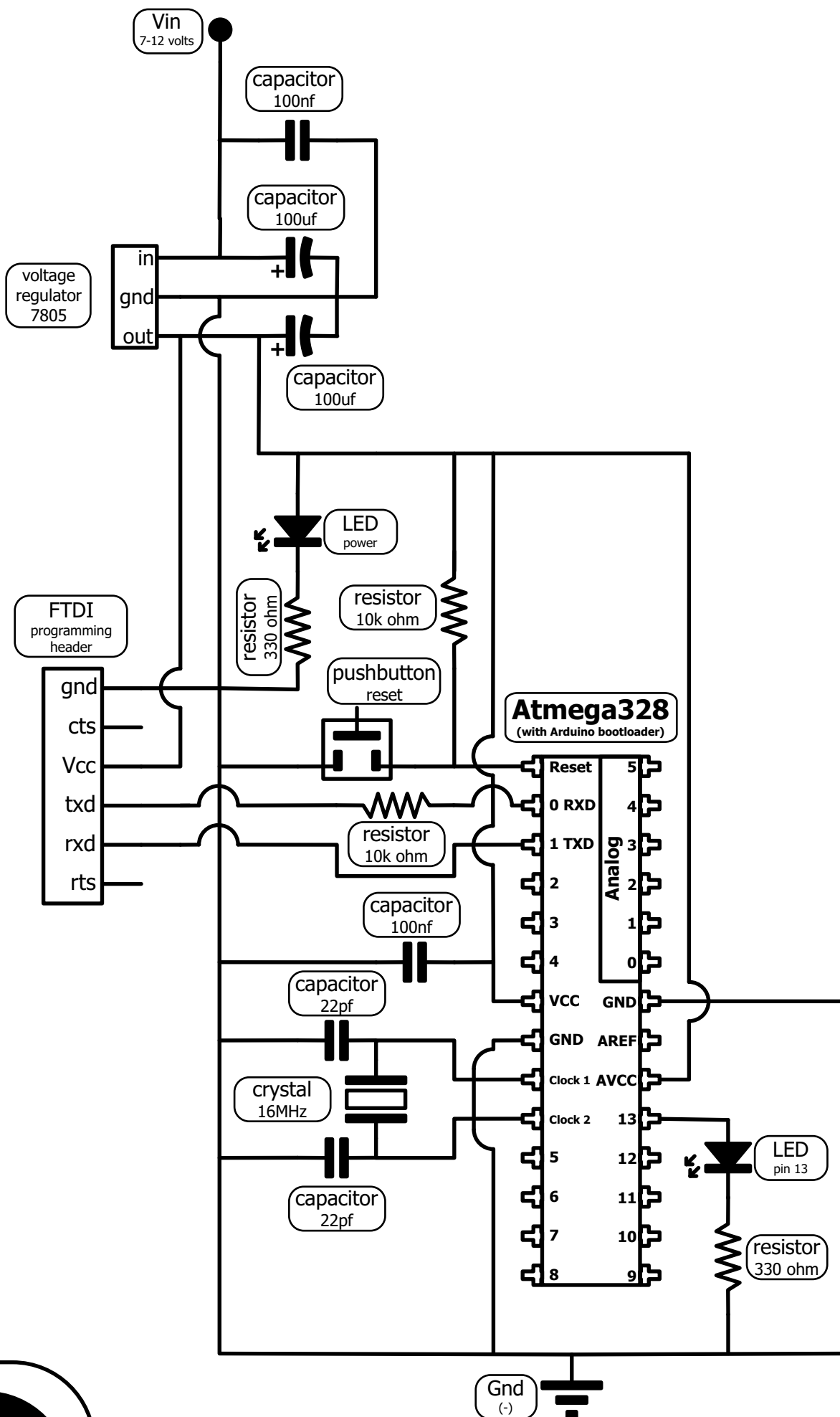

.: Breadboard Arduino Compatible:.

04 ASEM

assembly

.:Assembly Steps:.

Parts:



Breadboard
x1



Breadboard
Layout sheet
x1



2 Pin Header
x3

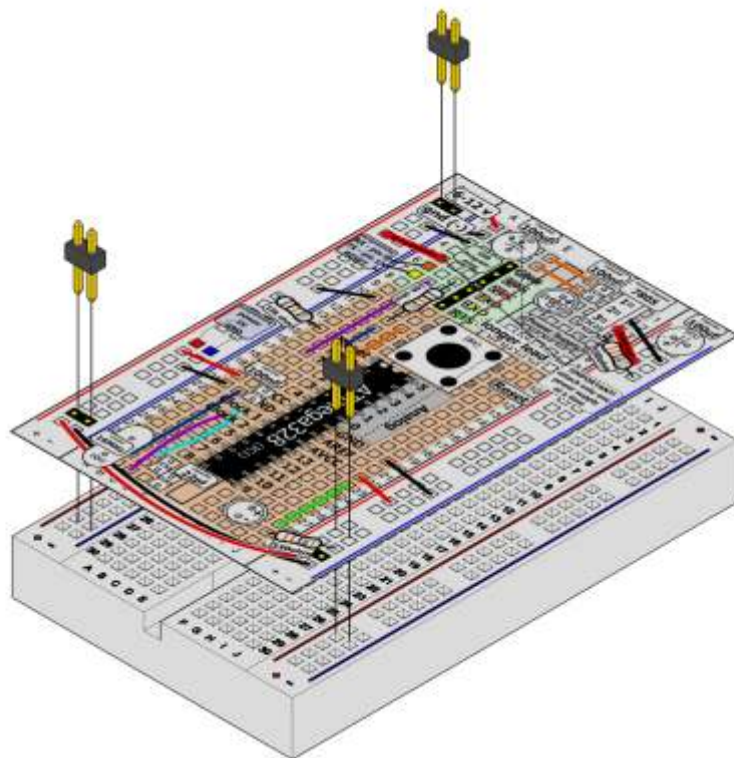

1

Parts:



wire



330 ohm resistor
(orange-orange-brown)
x2



10k ohm resistor
(brown-black-orange)
x2

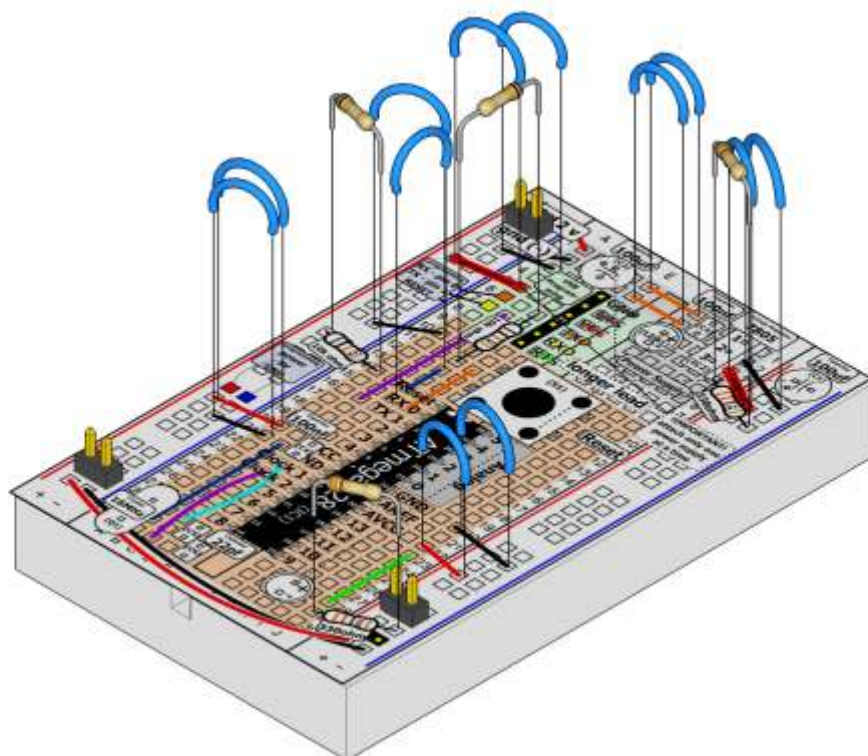

2

05

04 ASEM assembly

Parts:



Capacitor
100 uf
x2



Capacitor
100 nf (104)
x2



Capacitor
22 pf (220)
x2

the smoothing capacitors will
have 220 written on them

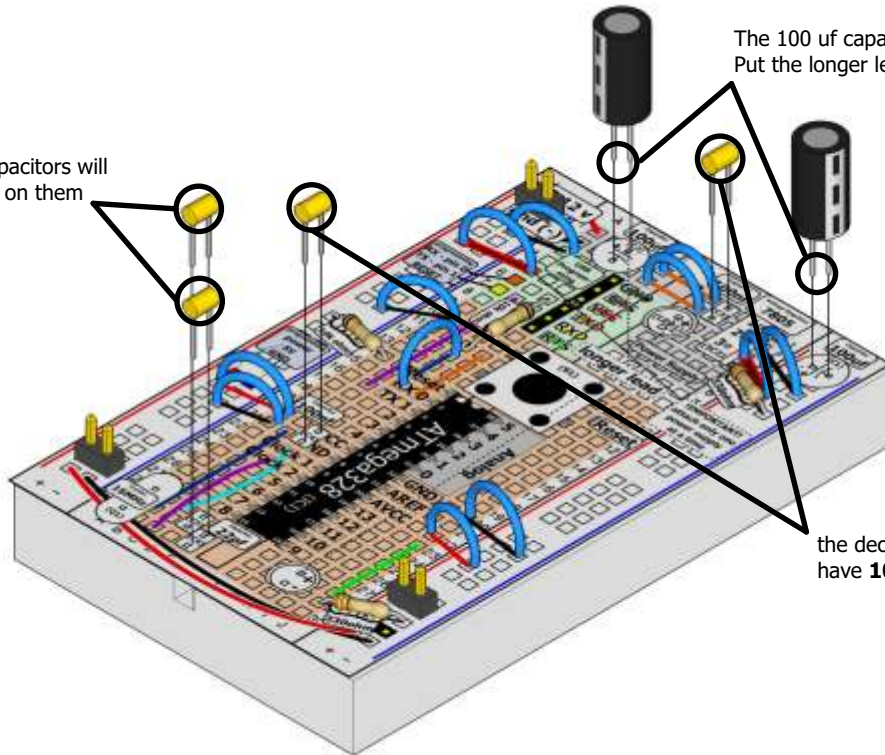

The 100 uf capacitors are polarized.
Put the longer lead in the indicated hole

the decoupling capacitors will
have 104 written on them

3

Parts:



Pushbutton
x1



Header (6 pin)
x1



Red LED
x1



Green LED
x1

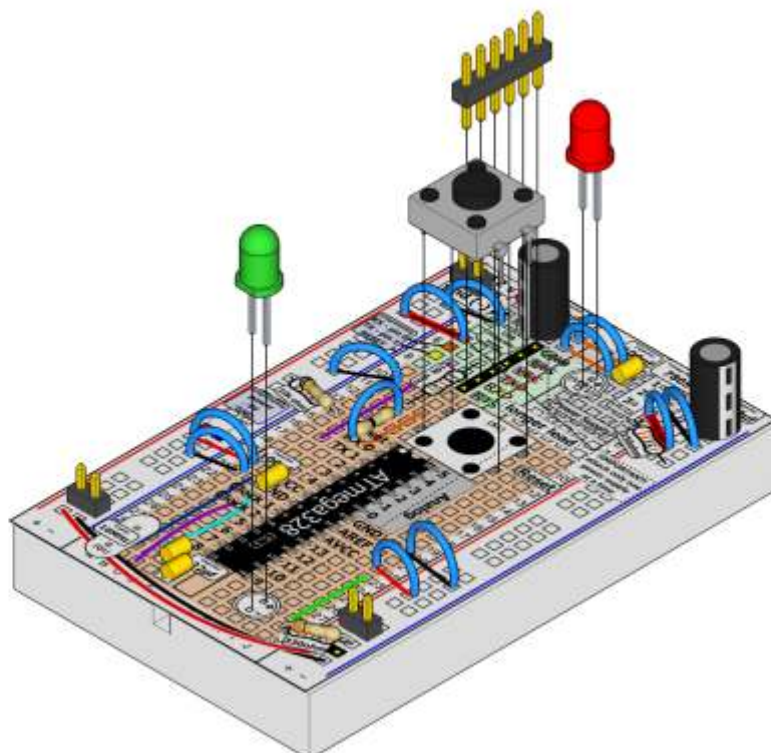

4

Parts:



Microcontroller
ATmega328
x1



Crystal
(16 MHz)
x1



Voltage Regulator
(7805)
x1

There is a half moon cutout, this goes at the top

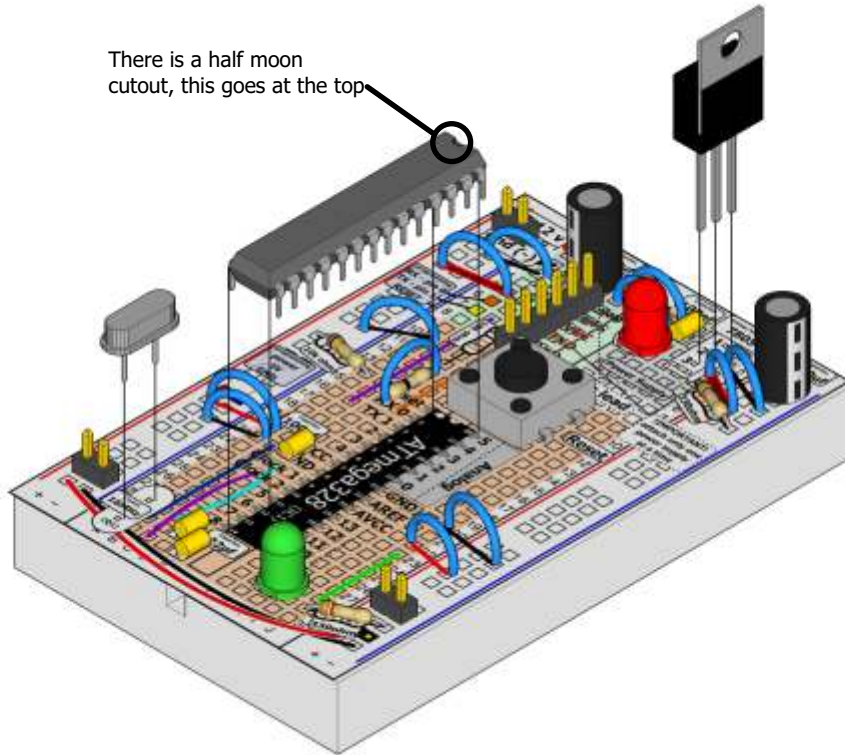

5

Parts:



Wire



Battery Clip
x1

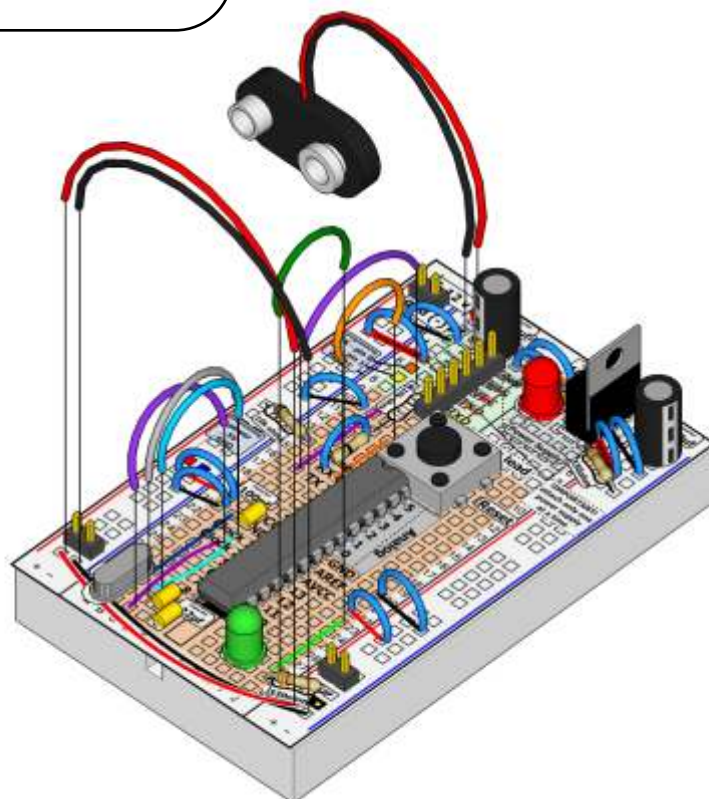

6

07

:: Programming Your Arduino Compatible:
(you can either use an Arduino Duemilanove board or an FTDI USB-Serial cable to program your BBAC)

Using an Arduino USB Board

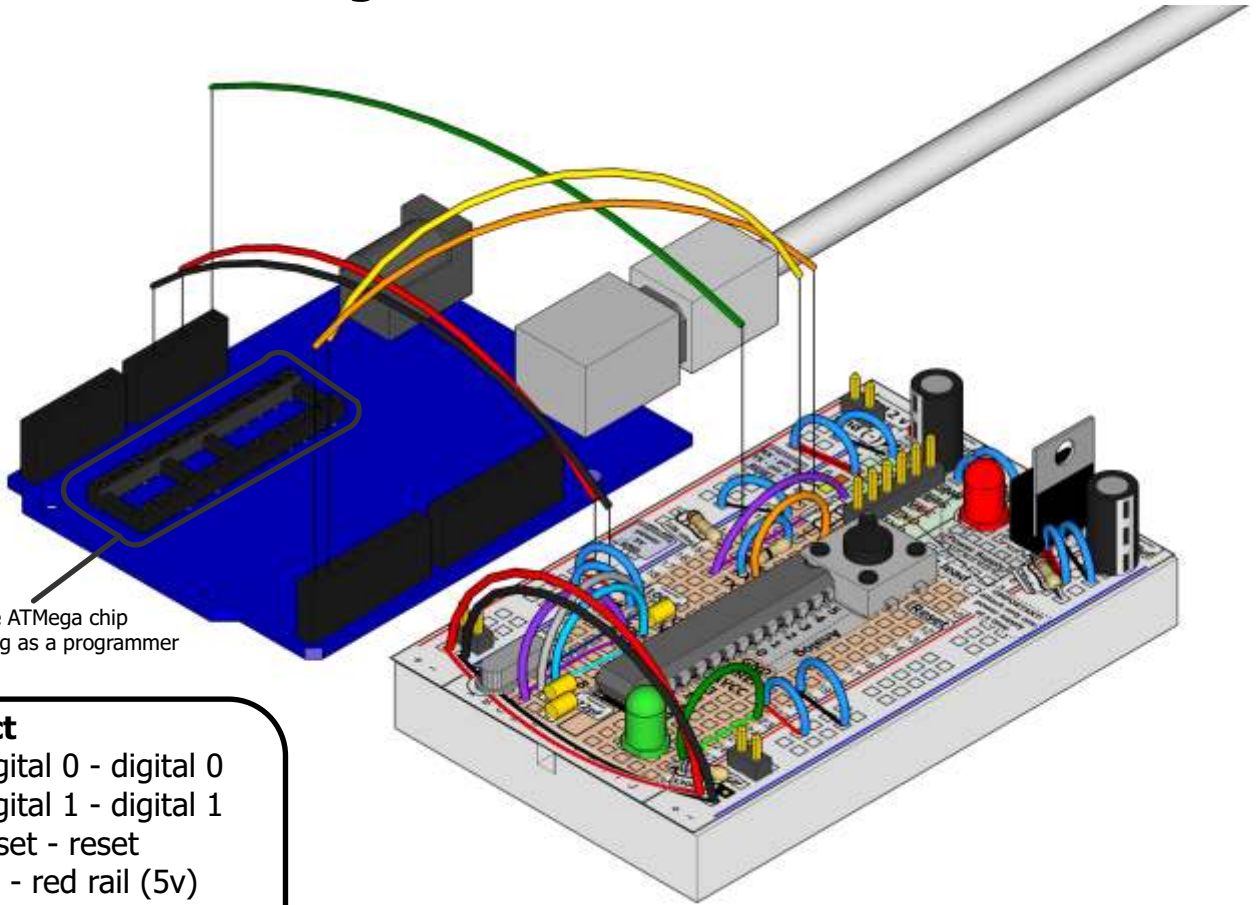

remove the ATmega chip
before using as a programmer

connect

1. digital 0 - digital 0
2. digital 1 - digital 1
3. reset - reset
4. 5v - red rail (5v)
5. gnd - blue rail (gnd)

Using an FTDI USB - Serial Cable

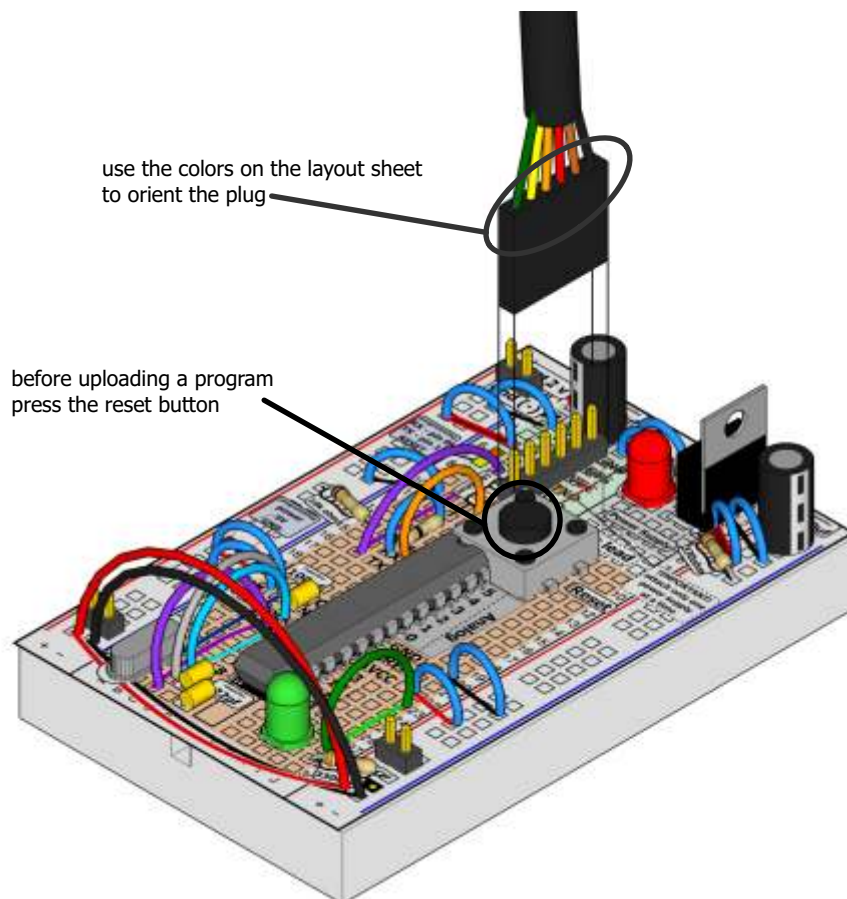

use the colors on the layout sheet
to orient the plug

before uploading a program
press the reset button

∴ Notes∴

∴Room for a Few Notes∴

06 NOTE
notes

A large rectangular area with rounded corners, filled with horizontal lines for writing notes. The lines are evenly spaced and extend across the width of the page, leaving a small margin at the top and bottom.

(BBAC)
breadboard arduino
compatible

sparkfun.com

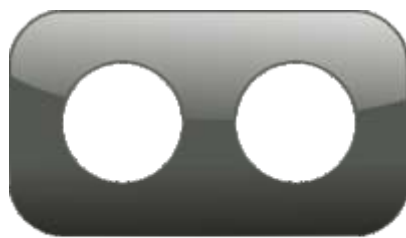

www.oomlout.com

This work is licenced under the Creative Commons Attribution-Share Alike 3.0 Unported License. To view a copy of this licence, visit <http://creativecommons.org/licenses/by-sa/3.0/> or send a letter to Creative Commons, 171 Second Street, Suite 300, San Francisco, California 94105, USA.