

TENSIONER PULLEY (1), 1/8" THICK WOOD

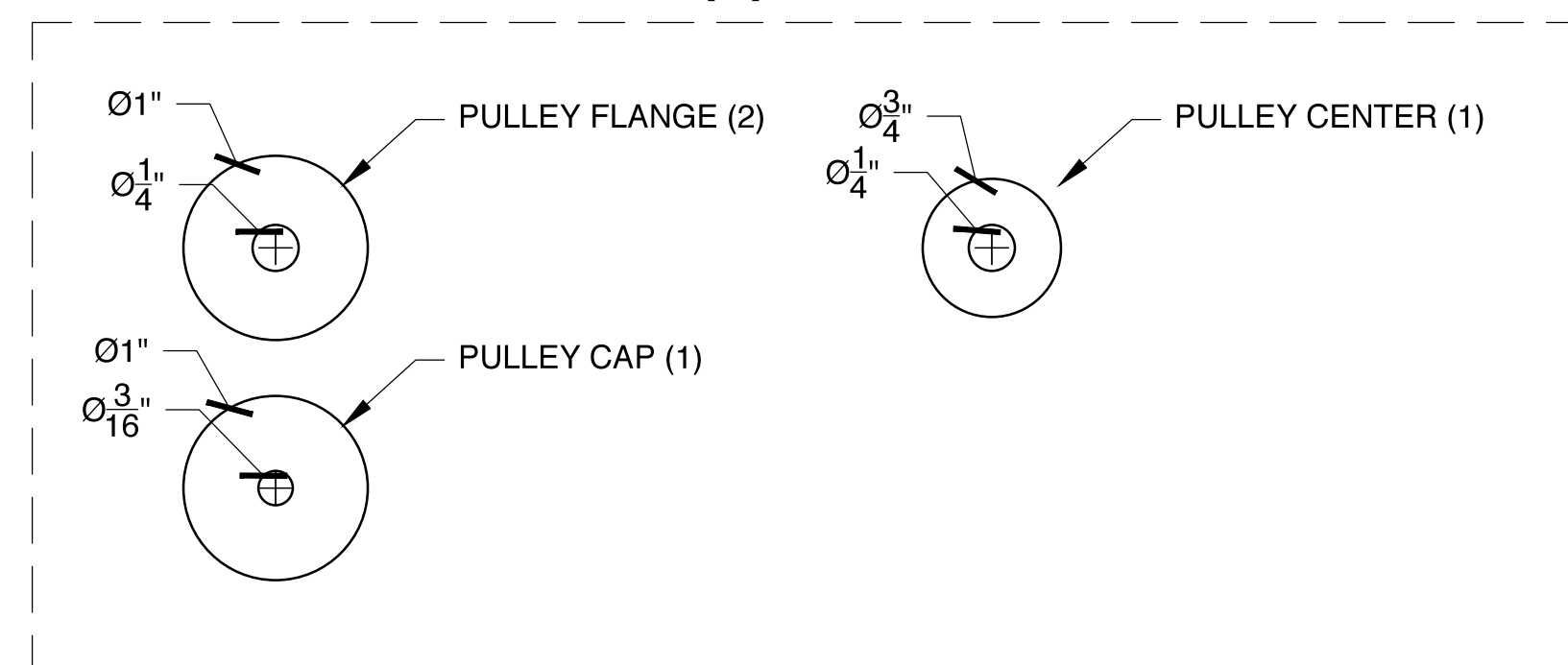

CRANKS (2), 1/2" THICK WOOD

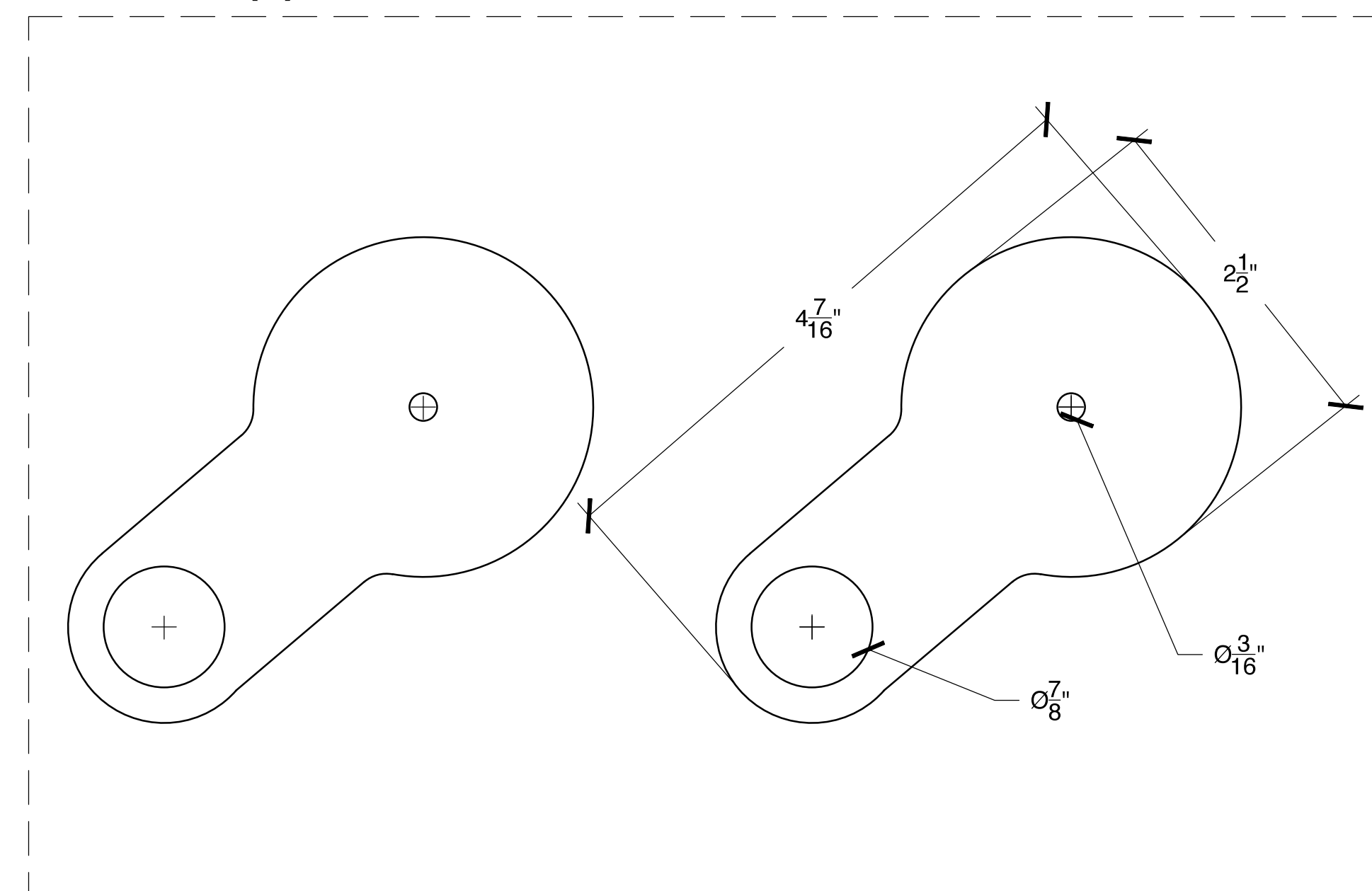

DOWELS

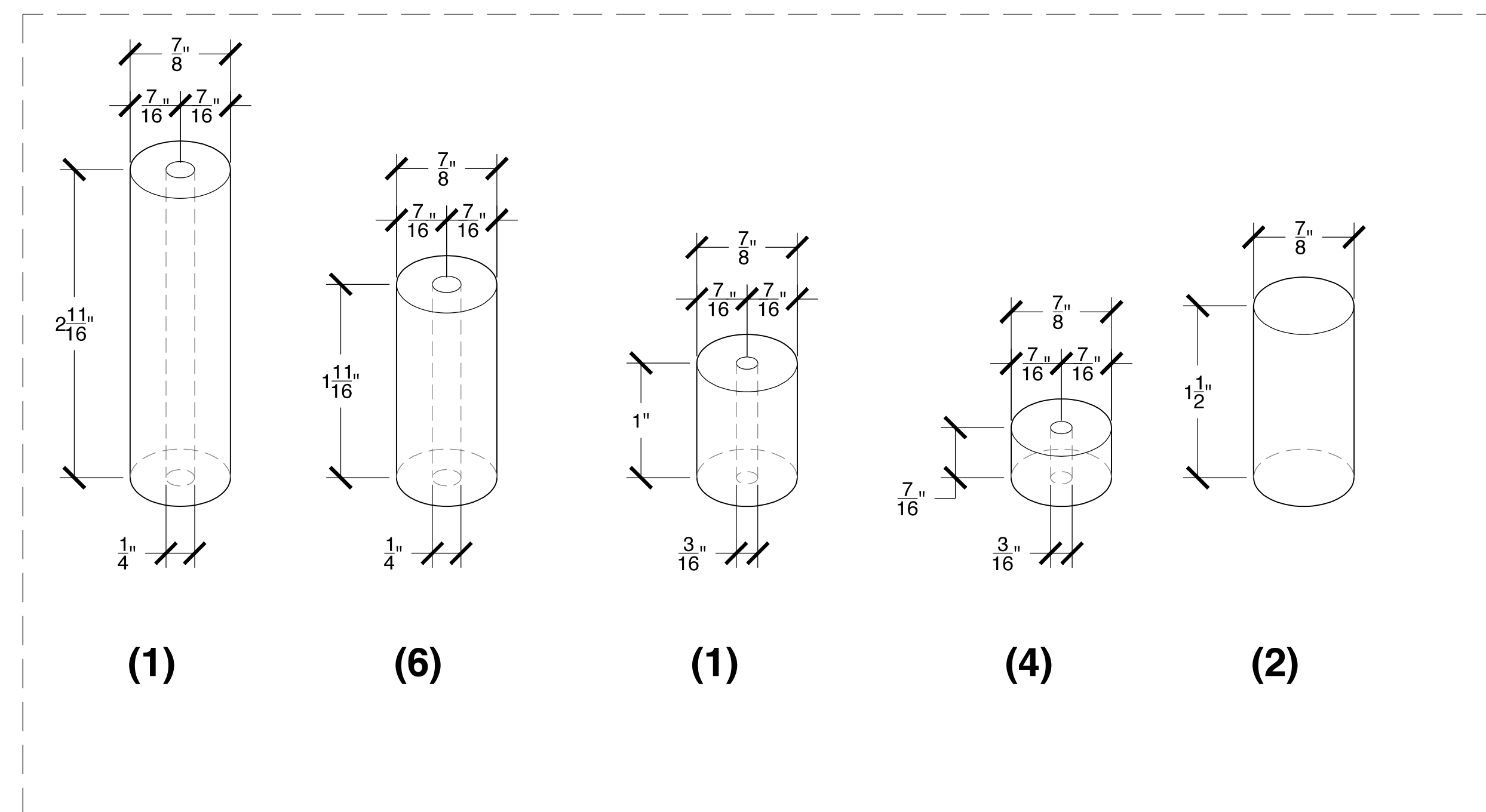

DRIVER PULLEYS (2), 1/4" THICK RUBBER

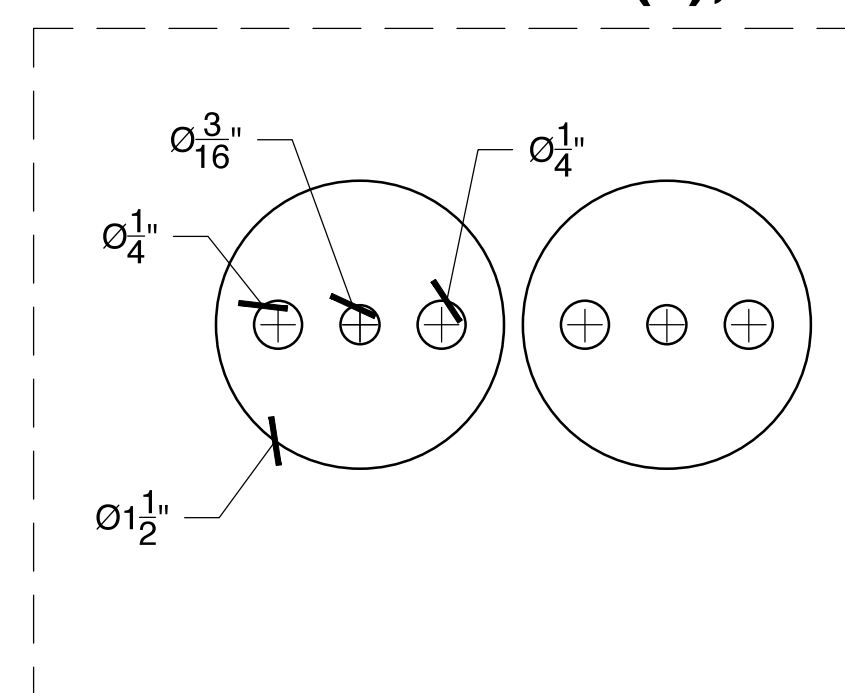

DRIVER PULLEYS (2), 1/8" THICK WOOD

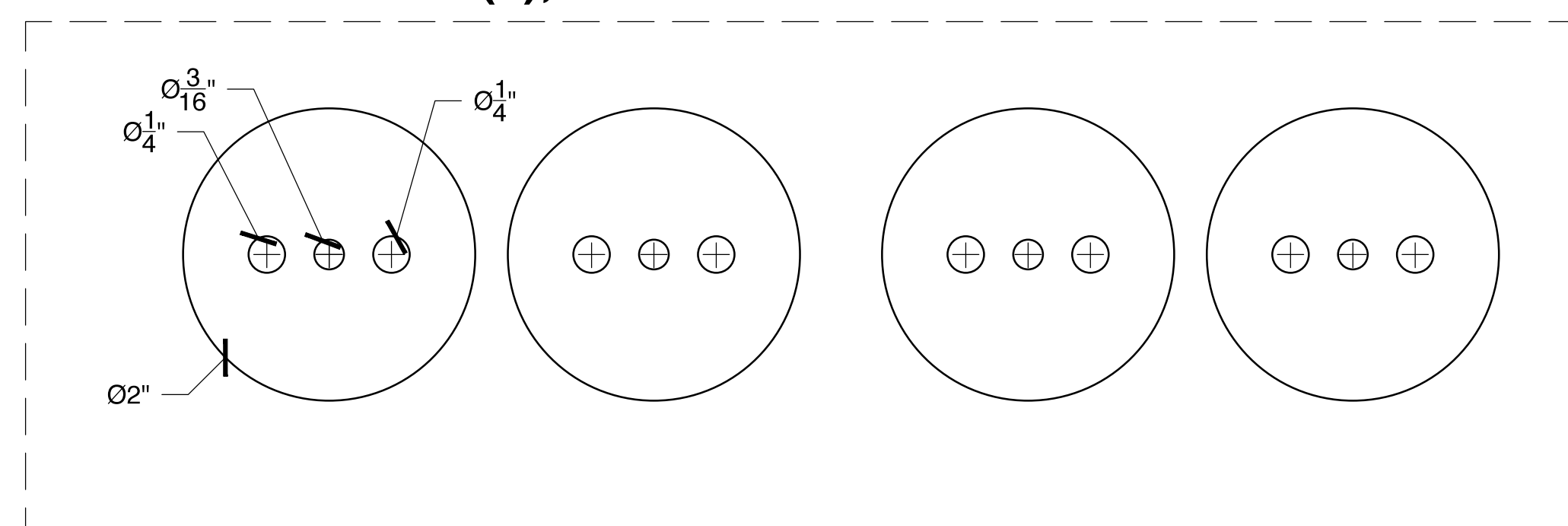

STANDARD PULLEYS (8), 1/8" THICK WOOD

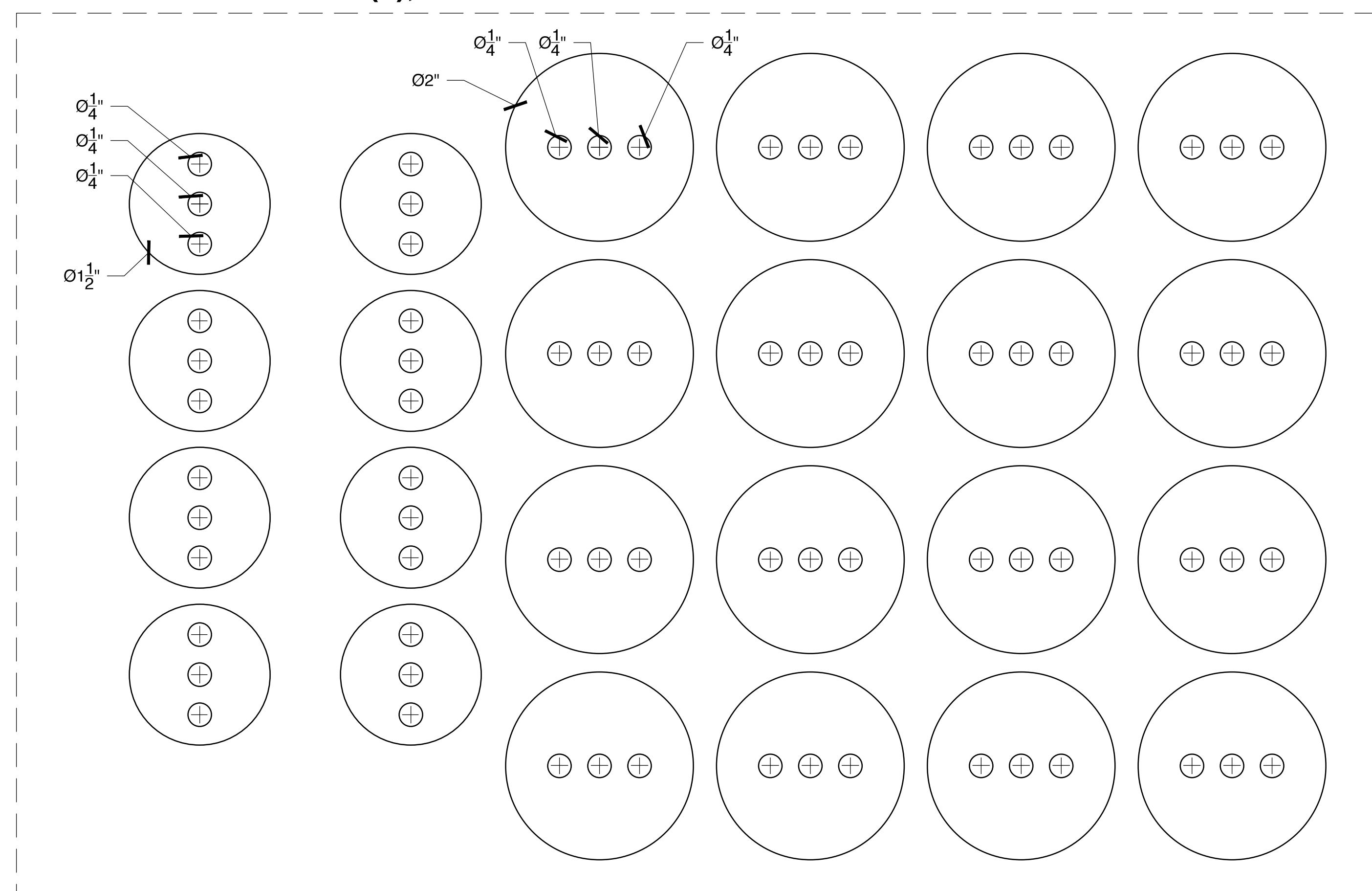

AXLE CAPS (2 EA), 1/8" THICK WOOD

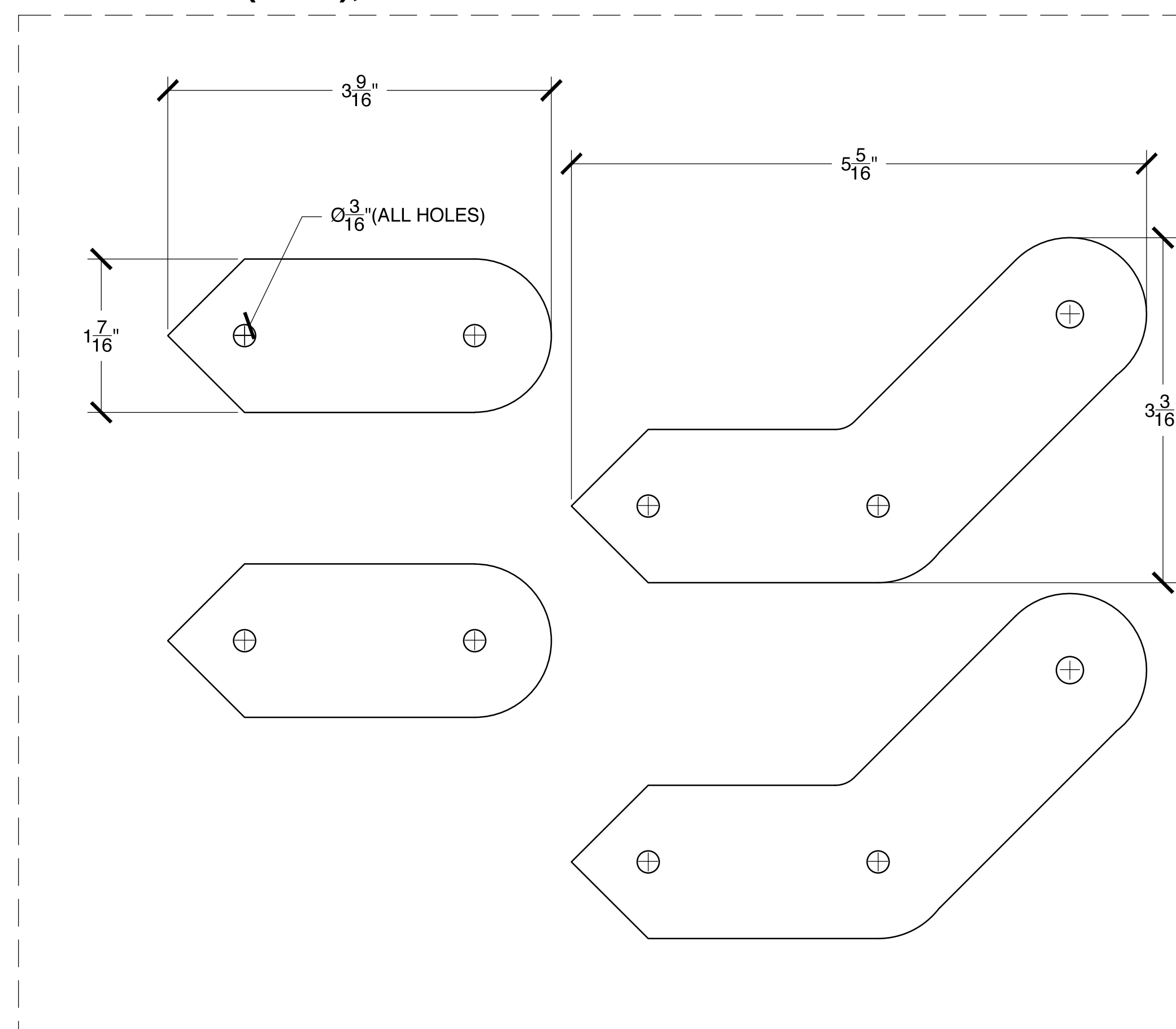

TO USE AS TEMPLATE, PRINT AT FULL SCALE (100%) ON 24"X36" (ARCH D) PAPER

TRAY SIDES (2 EA), 1"X3/4"

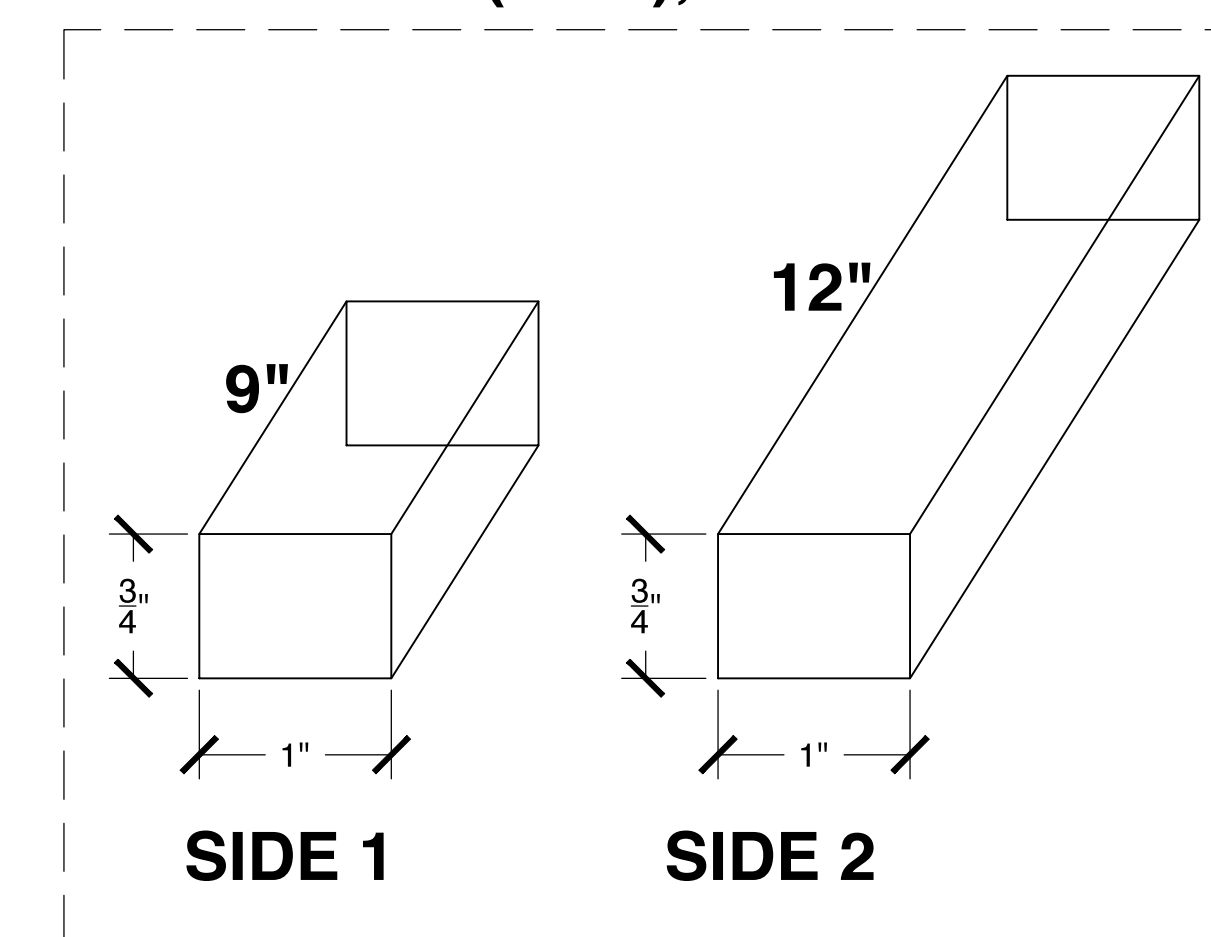

TRAY SIDES (4), 1"X1"X2 1/2"

