

Features

- Ideal for indication light on hand held products
- Long life and robust package
- White SMD package, silicone resin.
- Standard Package: 500pcs/ Reel
- MSL (Moisture Sensitivity Level): 3
- RoHS compliant.



ATTENTION
OBSERVE PRECAUTIONS
FOR HANDLING
ELECTROSTATIC
DISCHARGE
SENSITIVE
DEVICES



Package Schematics

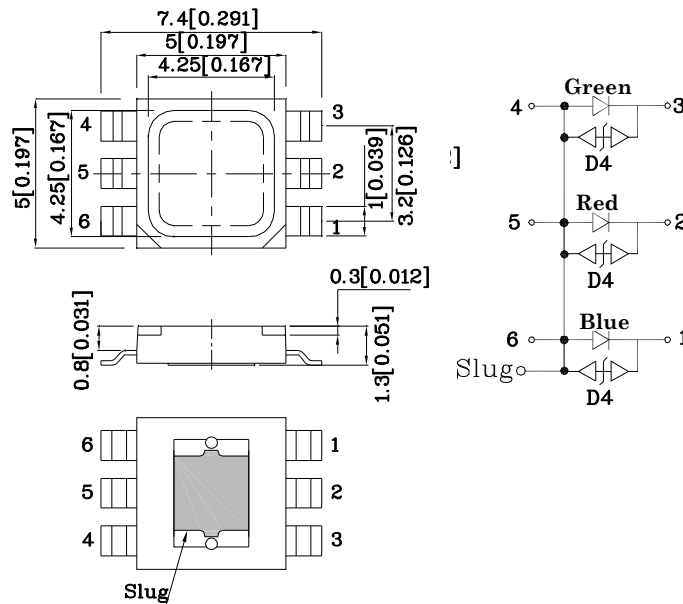

Notes:

1. All dimensions are in millimeters (inches).
2. Tolerance is $\pm 0.15 [\pm 0.006]$ unless otherwise noted.
3. Specifications are subject to change without notice.

Handling Precautions

Compare to epoxy encapsulant that is hard and brittle, silicone is softer and flexible. Although its characteristic significantly reduces thermal stress, it is more susceptible to damage by external mechanical force.

As a result, special handling precautions need to be observed during assembly using silicone encapsulated LED products. Failure to comply might lead to damage and premature failure of the LED.

1. Handle the component along the side surfaces by using forceps or appropriate tools.

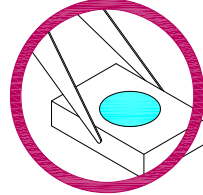

2. Do not directly touch or handle the silicone lens surface. It may damage the internal circuitry.

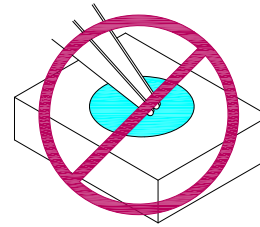
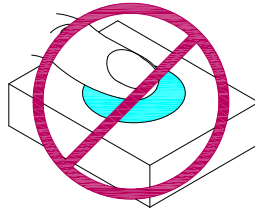

3. Do not stack together assembled PCBs containing exposed LEDs. Impact may scratch the silicone lens or damage the internal circuitry.

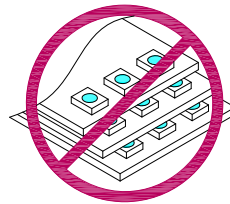

- 4.1. The inner diameter of the SMD pickup nozzle should not exceed the size of the LED to prevent air leaks.
- 4.2. A pliable material is suggested for the nozzle tip to avoid scratching or damaging the LED surface during pickup.
- 4.3. The dimensions of the component must be accurately programmed in the pick-and-place machine to insure precise pickup and avoid damage during production.

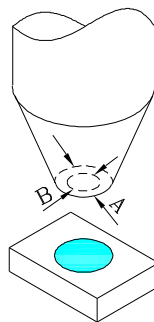

5. As silicone encapsulation is permeable to gases, some corrosive substances such as H₂S might corrode silver plating of leadframe. Special care should be taken if an LED with silicone encapsulation is to be used near such substances.

Selection Guide

Part Number	Emitting Color	Emitting Material	Lens-color	Luminous Intensity CIE127-2007* [2] (IF=150mA) cd		Luminous Flux CIE127-2007* [2] (IF=150mA) lm			Viewing Angle 2 θ 1/2 [1]
				min.	typ.	min.	typ.	max.	
XZCB25MO24DG25X111S	Blue	InGaN	Water Clear	1*	1.59*	2.9*	4*	6	120°
	Red	AlGaInP		2.7*	4.29*	8.6*	10.7*	17	
	Green	InGaN		4.2*	5.99*	12*	16.7*	29	

Notes:

1. θ1/2 is the angle from optical centerline where the luminous intensity is 1/2 of the optical peak value.
2. Luminous intensity/ luminous Flux: +/-15%. *LEDs are binned according to their luminous flux.
- * Luminous Intensity/Luminous Flux value is in accordance with CIE127-2007 standards.

Absolute Maximum Ratings at Ta=25°C

Parameter	Symbol	Emitting Color	Value	Unit
Power dissipation	PD	Blue	0.6	W
		Red	0.45	
		Green	0.6	
Junction temperature	Tj	Blue	110	°C
		Red	110	
		Green	110	
Operating Temperature	Top	Blue	-40 To +85	°C
		Red		
		Green		
Storage Temperature	Tstg	Blue	-40 To +85	°C
		Red		
		Green		
DC Forward Current [1]	IF	Blue	150	mA
		Red	150	
		Green	150	
Peak Forward Current [2]	IFM	Blue	300	mA
		Red	300	
		Green	300	
Thermal resistance	Rth j-a	Blue	220	°C/W
		Red	270	
		Green	200	
Thermal resistance	Rth j-s	Blue	25	°C/W
		Red	40	
		Green	33	

Notes:

1. Results from mounting on Aluminum Board.
2. 1/10 Duty Cycle, 0.1ms Pulse Width.
3. A Relative Humidity between 40% and 60% is recommended in ESD-protected work areas to reduce static build up during assembly process (Reference JEDEC/ JESD625-A and JEDEC/J-STD-033)

Electrical / Optical Characteristics at Ta=25°C

Parameter	Symbol	Emitting Color	Value			Unit
			Min.	Typ.	Max.	
Wavelength at peak emission CIE127-2007* IF=150mA	λ_{peak}	Blue		452*		nm
Wavelength at peak emission CIE127-2007* IF=150mA		Red		635*		
Wavelength at peak emission CIE127-2007* IF=150mA		Green		515*		
Dominant Wavelength CIE127-2007* IF=150mA	λ_{dom} [1]	Blue		460*	473*	nm
Dominant Wavelength CIE127-2007* IF=150mA		Red		624*	-	
Dominant Wavelength CIE127-2007* IF=150mA		Green		525*	535*	
Spectral Line Half-width IF=150mA	$\Delta\lambda_{1/2}$	Blue		20		nm
Spectral Line Half-width IF=150mA		Red		20		
Spectral Line Half-width IF=150mA		Green		30		
Forward Voltage IF=150mA	V_F [2]	Blue	3.0	3.5	4.0	V
Forward Voltage IF=150mA		Red	2.0	2.5	3.0	
Forward Voltage IF=150mA		Green	3.0	3.5	4.0	
Reverse Voltage	V_R	Blue			5	V
		Red			5	
		Green			5	
Temperature coefficient of λ_{peak} IF=150mA, $-10^{\circ}C \leq T \leq 100^{\circ}C$	$TC_{\lambda_{peak}}$	Blue		0.12		nm/°C
Temperature coefficient of λ_{peak} IF=150mA, $-10^{\circ}C \leq T \leq 100^{\circ}C$		Red		0.09		
Temperature coefficient of λ_{peak} IF=150mA, $-10^{\circ}C \leq T \leq 100^{\circ}C$		Green		0.13		
Temperature coefficient of λ_{dom} IF=150mA, $-10^{\circ}C \leq T \leq 100^{\circ}C$	$TC_{\lambda_{dom}}$	Blue		0.1		nm/°C
Temperature coefficient of λ_{dom} IF=150mA, $-10^{\circ}C \leq T \leq 100^{\circ}C$		Red		0.03		
Temperature coefficient of λ_{dom} IF=150mA, $-10^{\circ}C \leq T \leq 100^{\circ}C$		Green		0.11		
Temperature coefficient of V_F IF=150mA, $-10^{\circ}C \leq T \leq 100^{\circ}C$	TC_V	Blue		-2.3		mV/°C
Temperature coefficient of V_F IF=150mA, $-10^{\circ}C \leq T \leq 100^{\circ}C$		Red		-2.7		
Temperature coefficient of V_F IF=150mA, $-10^{\circ}C \leq T \leq 100^{\circ}C$		Green		-3.9		

Notes:

1. Wavelength: +/-1nm.

2. Forward Voltage: +/-0.2V.

*wavelength is in accordance with CIE127-2007 standards.

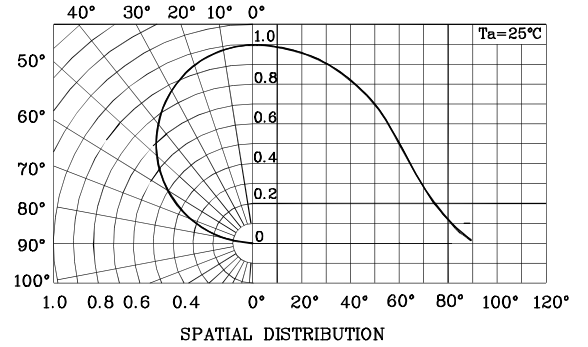
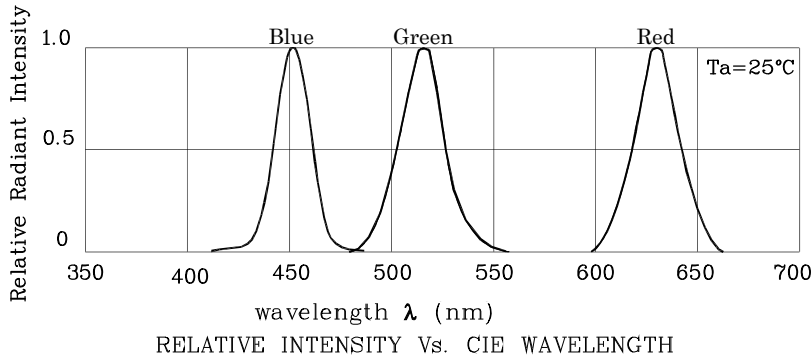

❖ Blue

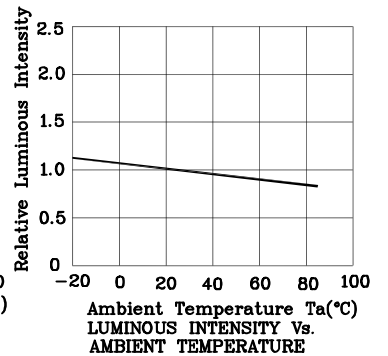
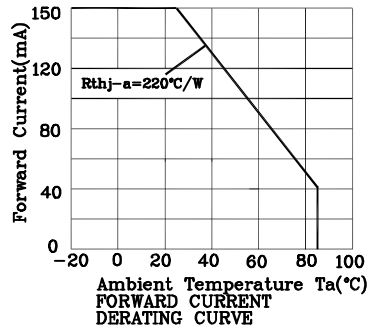
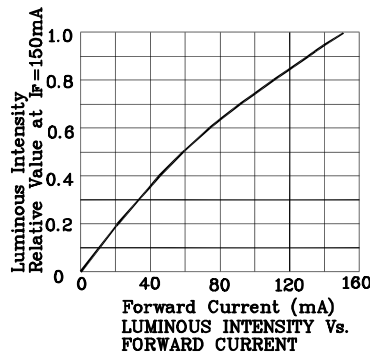
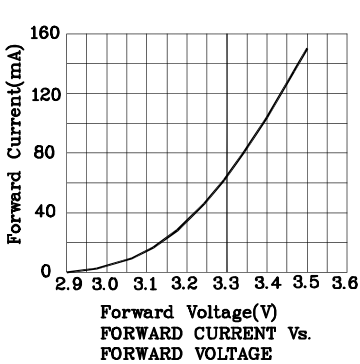

❖ Red

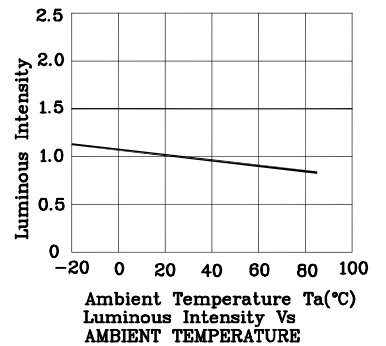
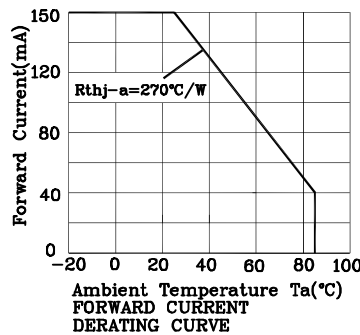
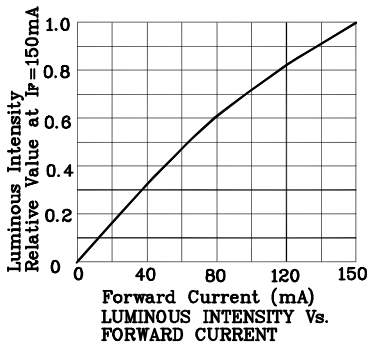
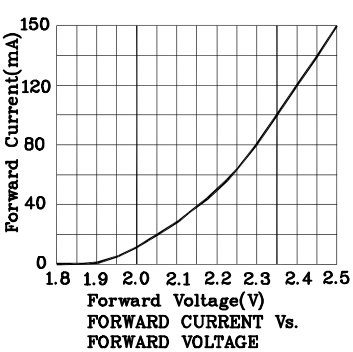

❖ Green

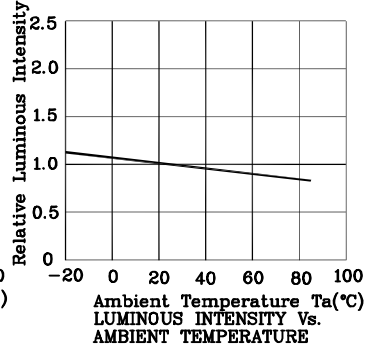
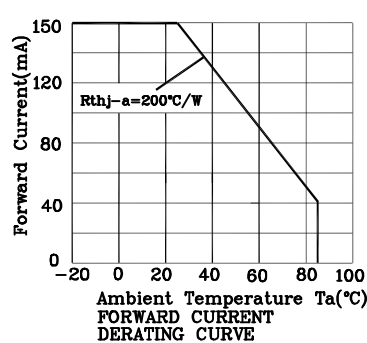
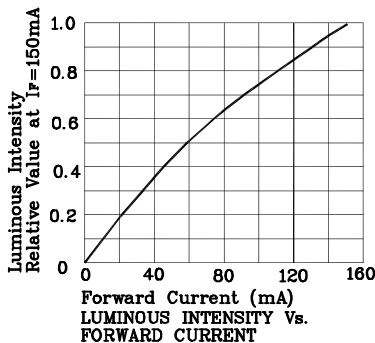
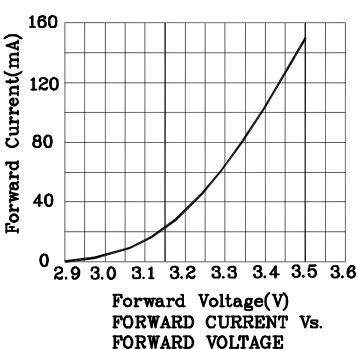

Reflow soldering is recommended and the soldering profile is shown below.
Other soldering methods are not recommended as they might cause damage to the product.

Reflow Soldering Profile For Lead-free SMT Process.

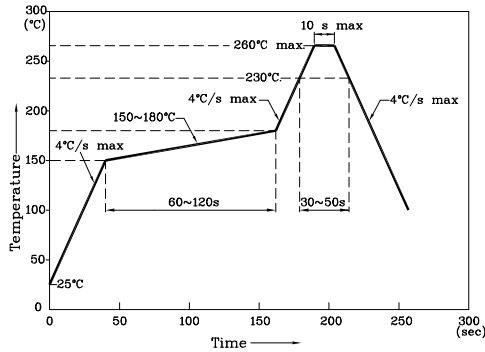

NOTES:

1. Maximum soldering temperature should not exceed 260°C.
2. Recommended reflow temperature: 145°C-260°C.
3. Do not put stress to the epoxy resin during high temperatures conditions.

Reel Dimension

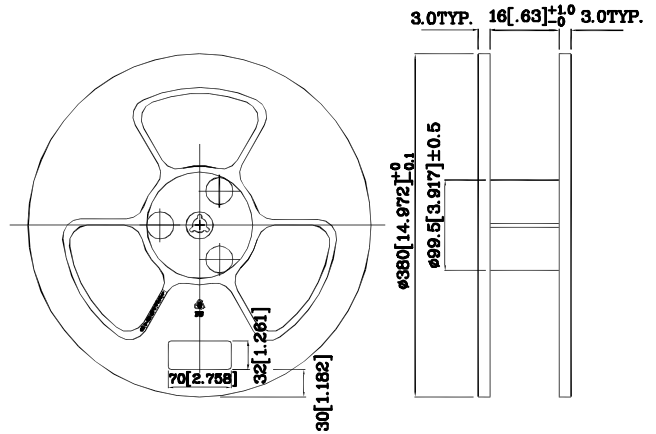

❖ Recommended Soldering Pattern
(Units : mm; Tolerance: ± 0.1)

❖ The device has a single mounting surface. The device must be mounted according to the specifications.

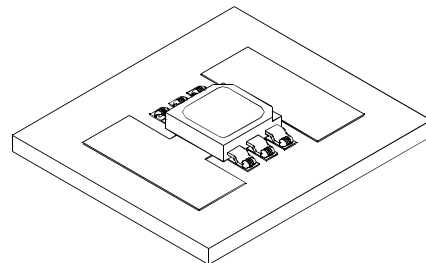
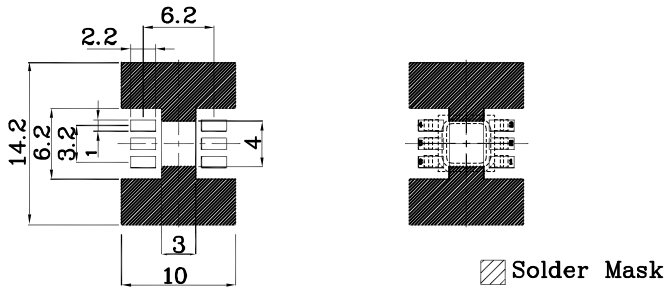

❖ Tape Specification (Units : mm)

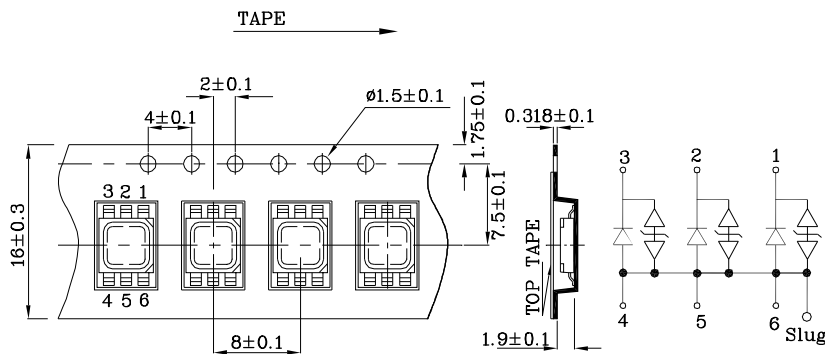

PACKING & LABEL SPECIFICATIONS

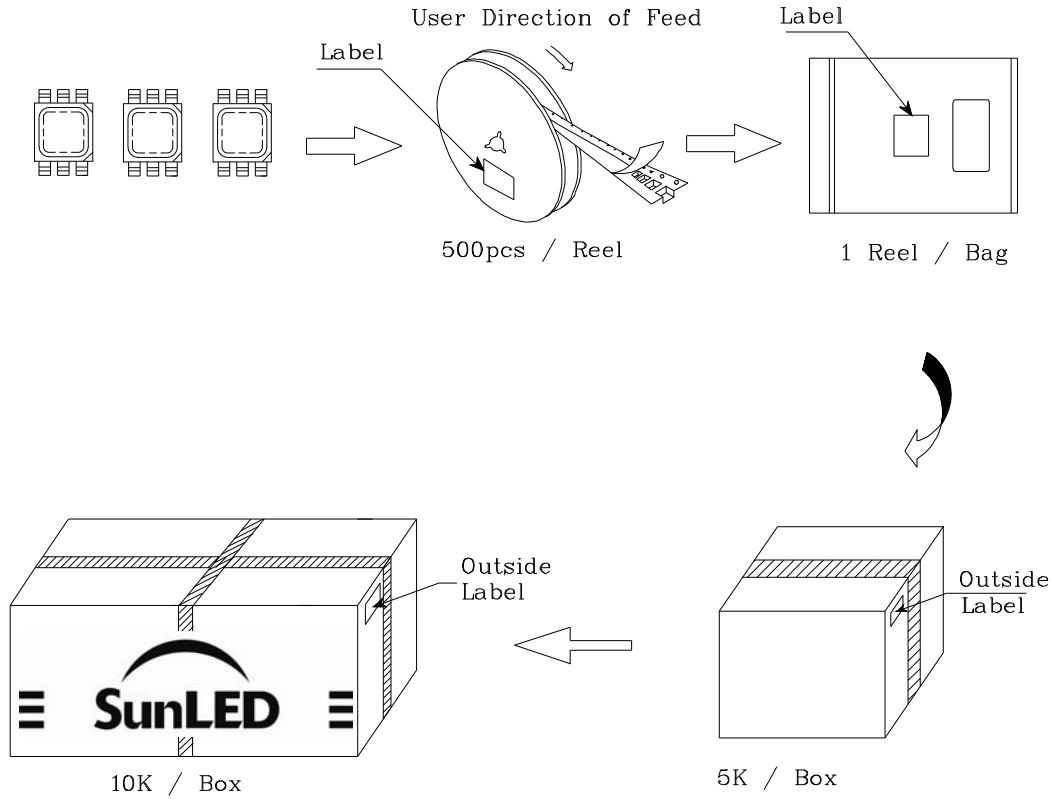



Q. C.

XX Q XX XXXX

PASSED

P/NO : XZxxx111x	
QTY : 500 pcs	CODE: XXX
S/N : XX	
LOT NO :	
 XXXXXXXXXXXXXXXXXXXXXXXXXXXX	
RoHS Compliant	

TERMS OF USE

1. Data presented in this document reflect statistical figures and should be treated as technical reference only.
2. Contents within this document are subject to improvement and enhancement changes without notice.
3. The product(s) in this document are designed to be operated within the electrical and environmental specifications indicated on the datasheet.
User accepts full risk and responsibility when operating the product(s) beyond their intended specifications.
4. The product(s) described in this document are intended for electronic applications in which a person's life is not reliant upon the LED. Please consult with a SunLED representative for special applications where the LED may have a direct impact on a person's life.
5. The contents within this document may not be altered without prior consent by SunLED.
6. Additional technical notes are available at <http://www.SunLEDusa.com/TechnicalNotes.asp>