

ITEM	QTY	PART NUMBER	DESCRIPTION
1	2	Dwarsbalk	68x43 L=908
2	2	Ligger	68x43 L=2161
3	4	Balkje	68x43 L=98
4	16	Plank Poot	100x22 L=738
5	2	Plank Eind	147x22 L=1000
6	1	Plank Midden	147x22 L=1000
7	6	Plank Blad	147x22 L=946
8	4	Plank Blad	69.5x22 L=946
9	8	Plank Blad	105x22 L=946
10	2	Plank Stoot	80x22 L=732
11	4	Stoot 1	80x22 L=639
12	2	Stoot 2	80x22 L=751

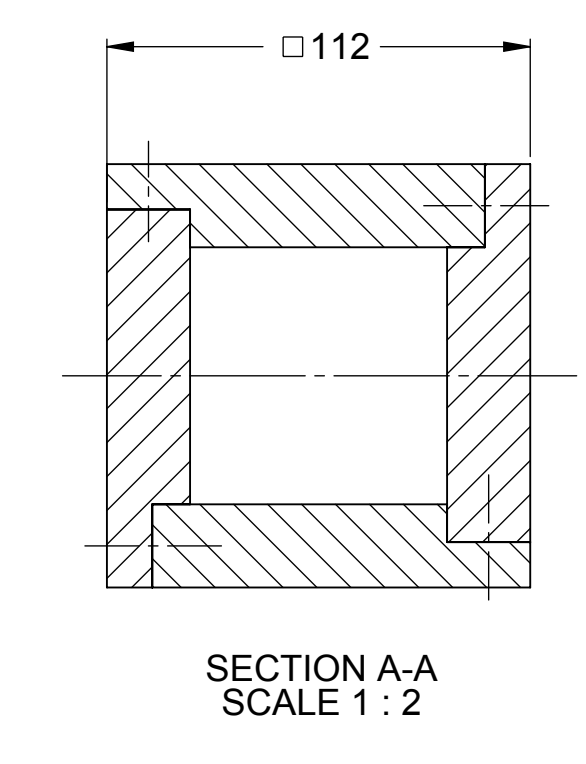
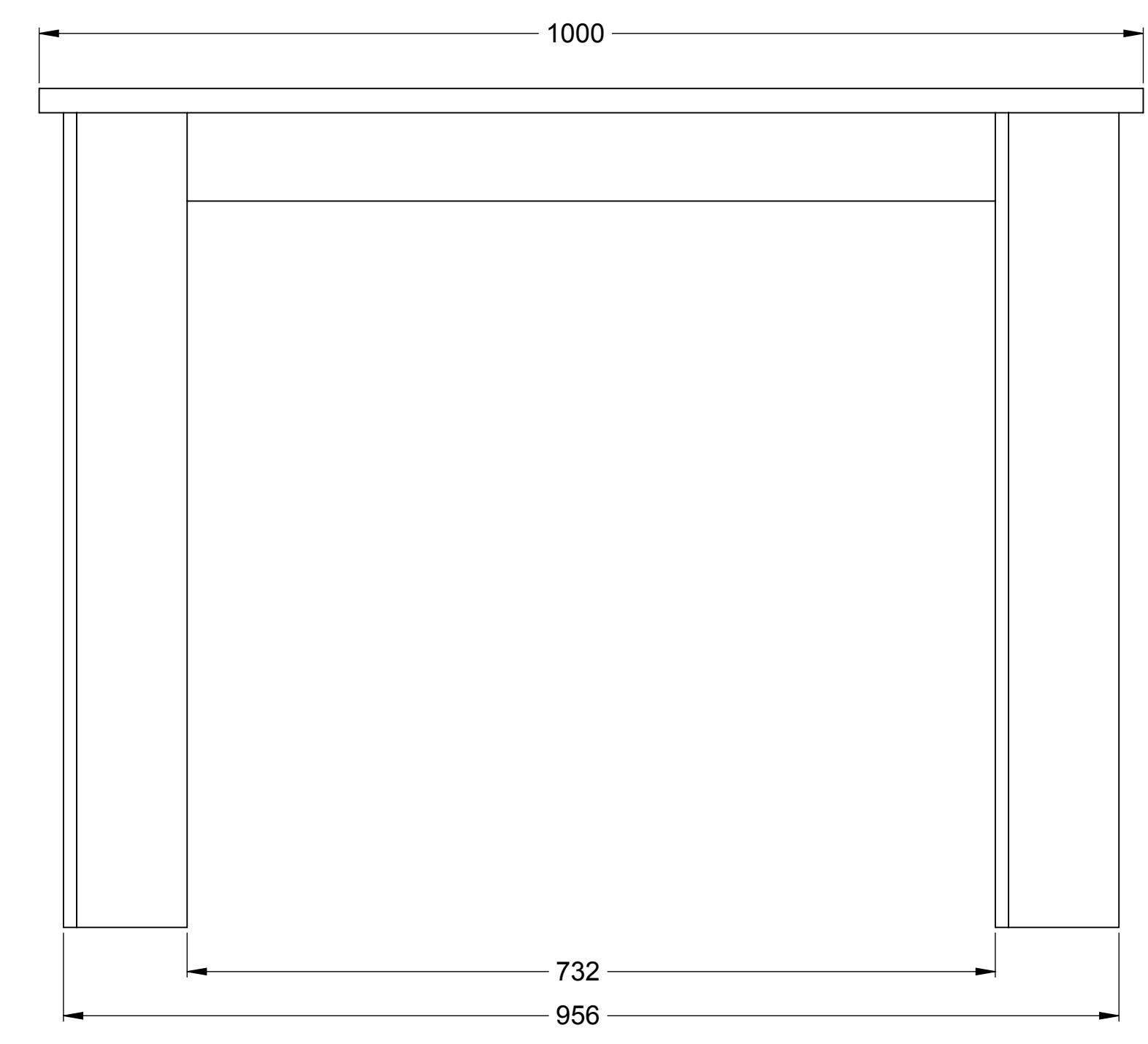
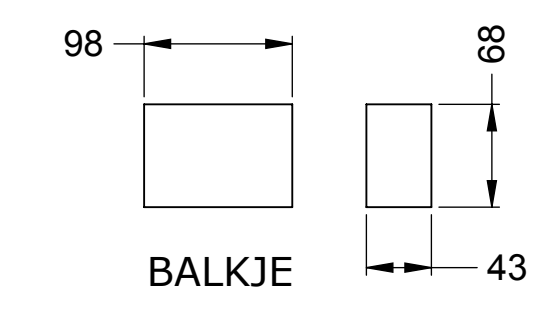
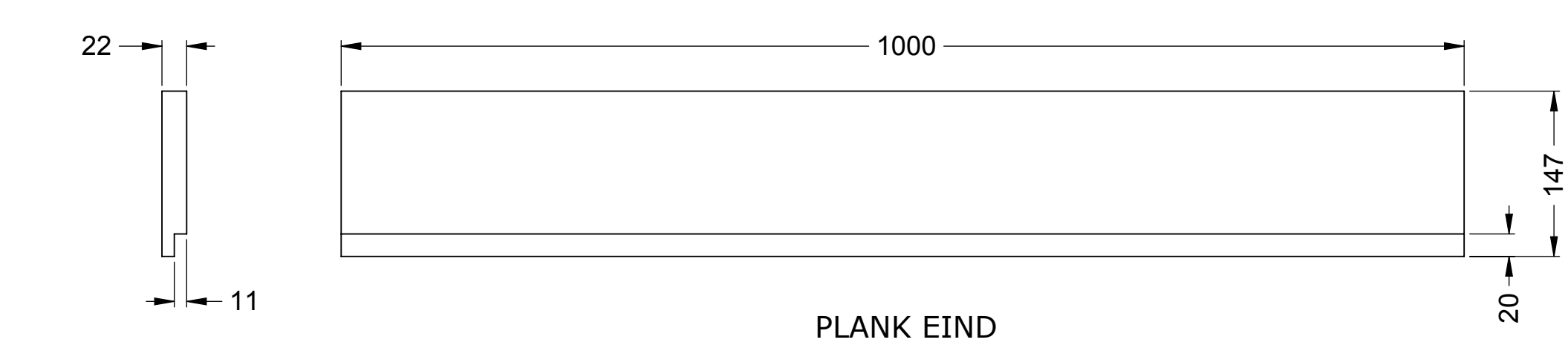
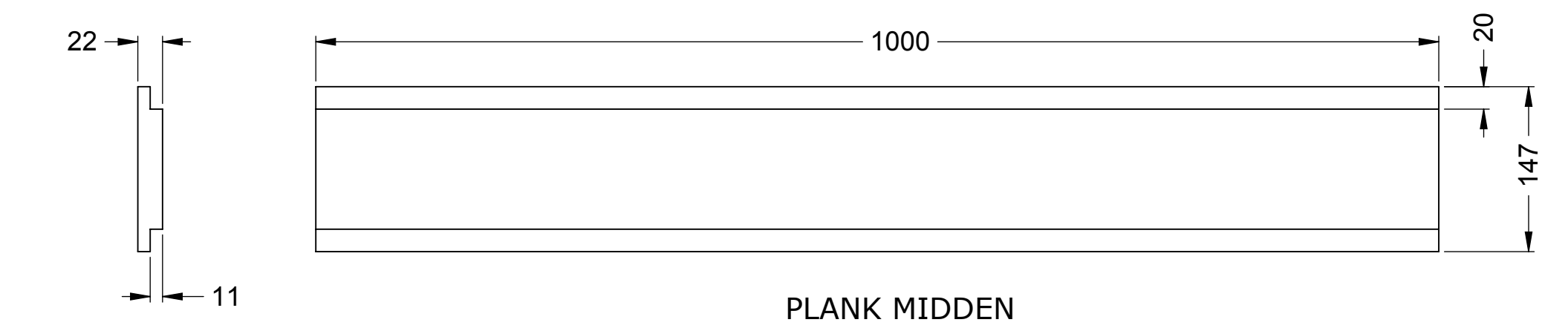
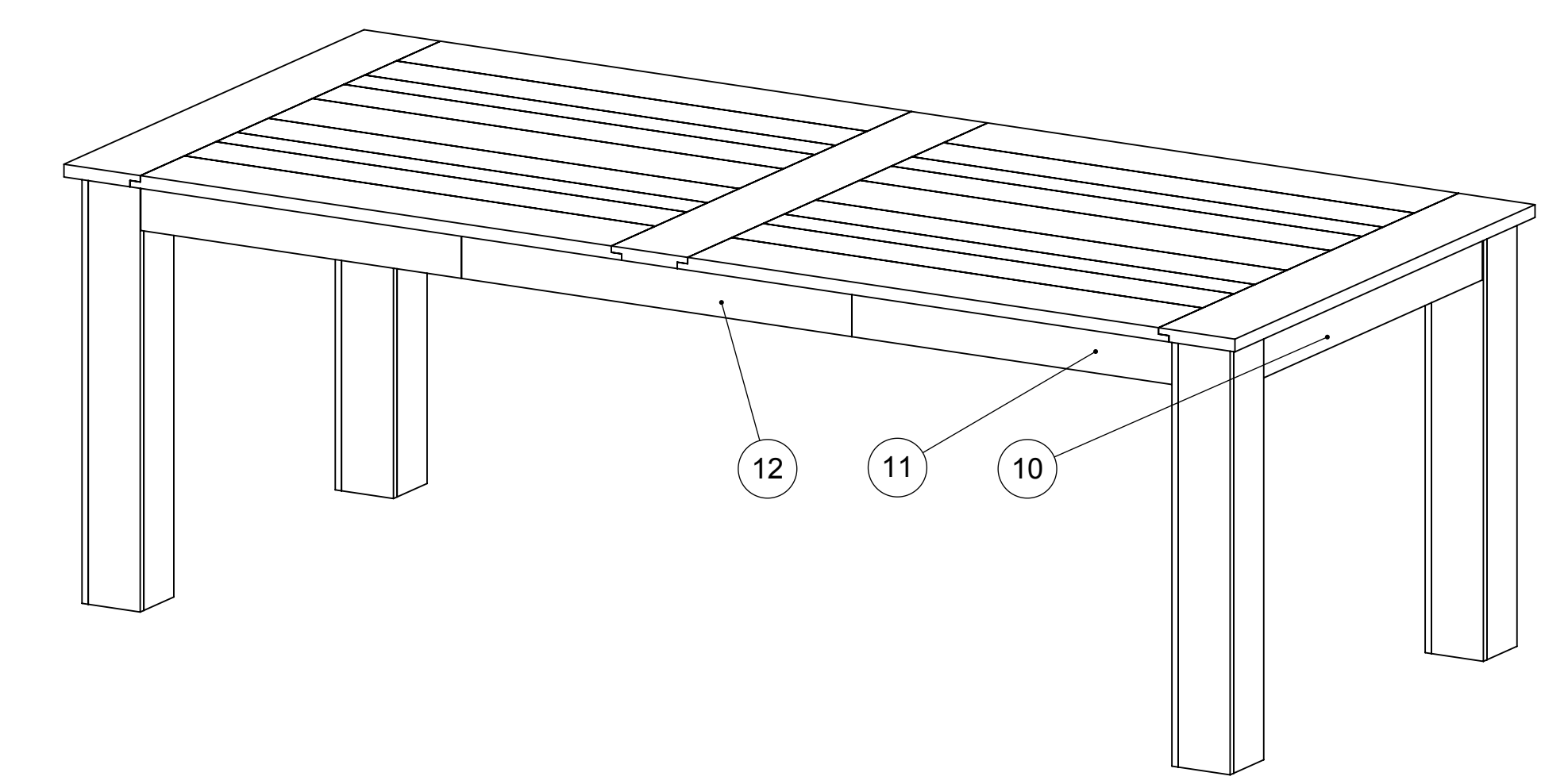
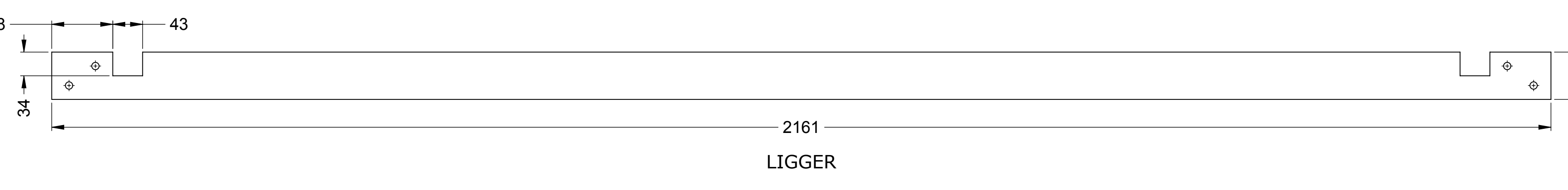
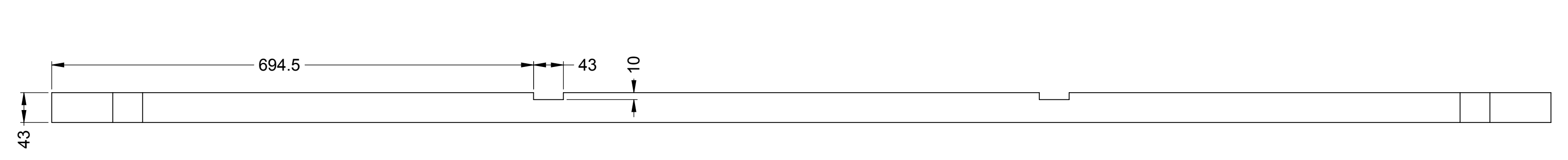
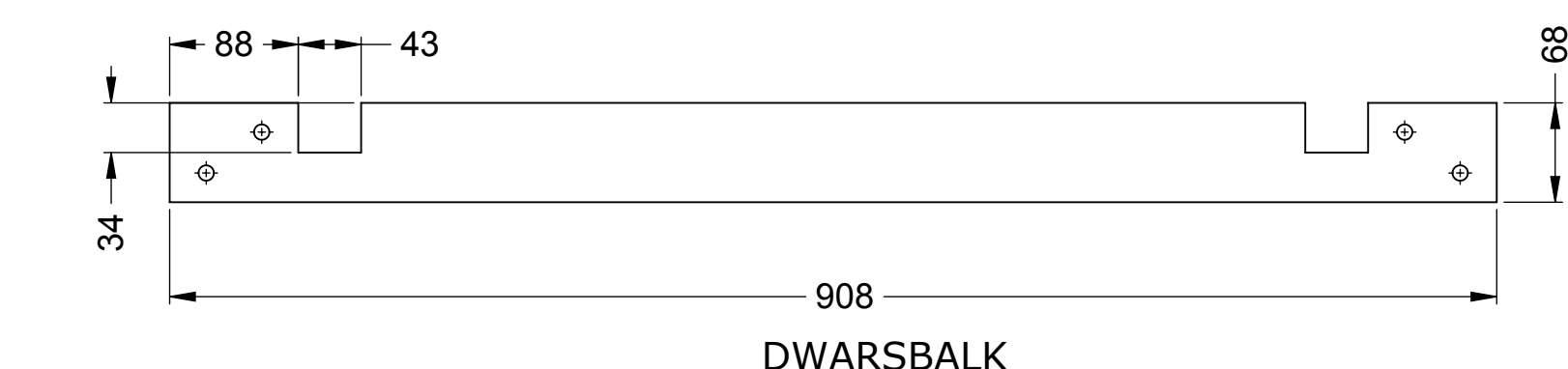
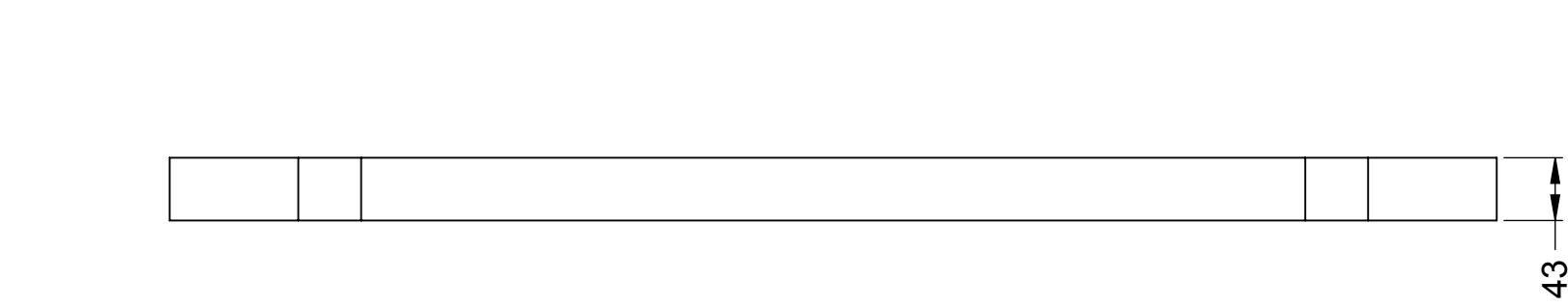
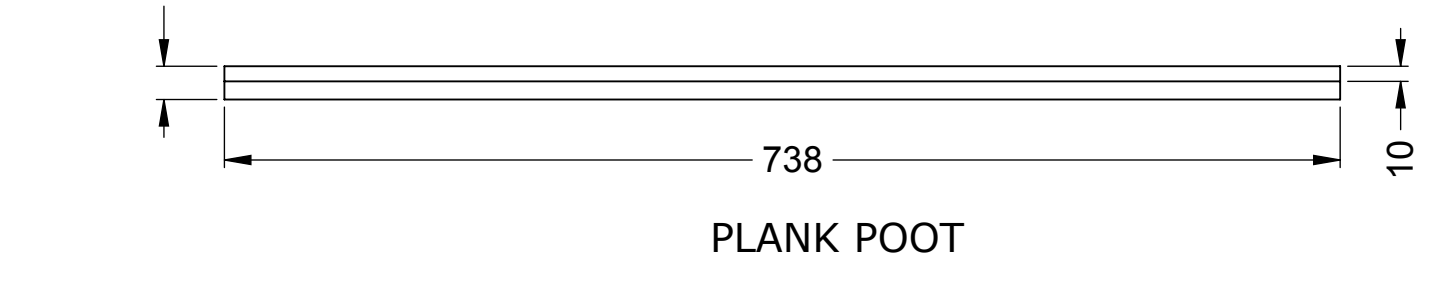
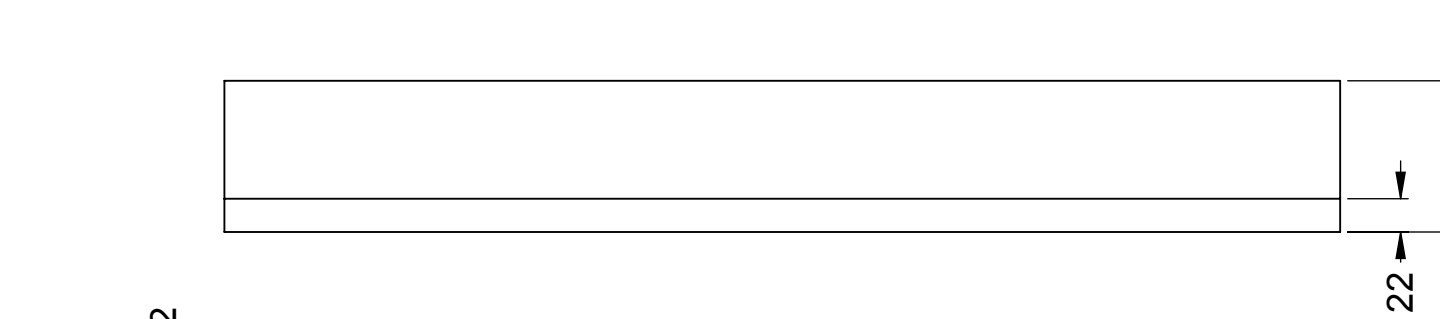
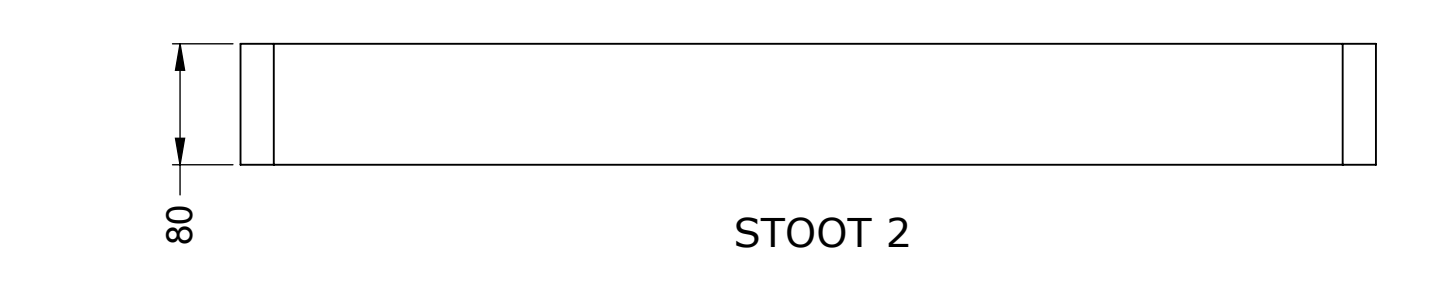
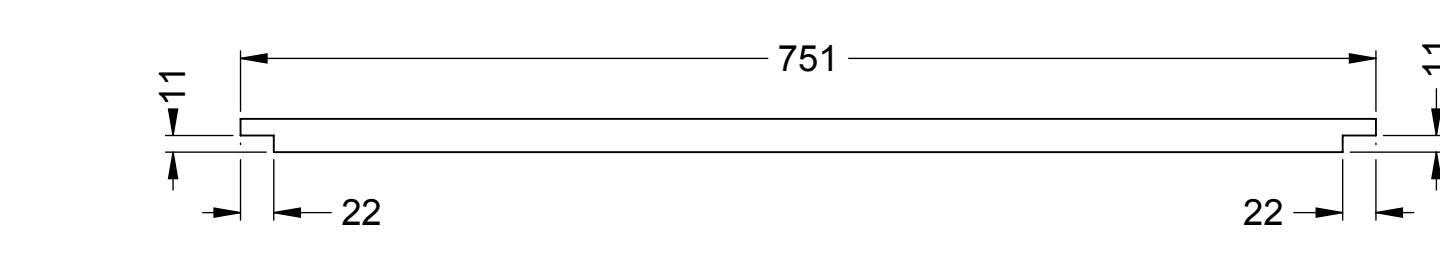
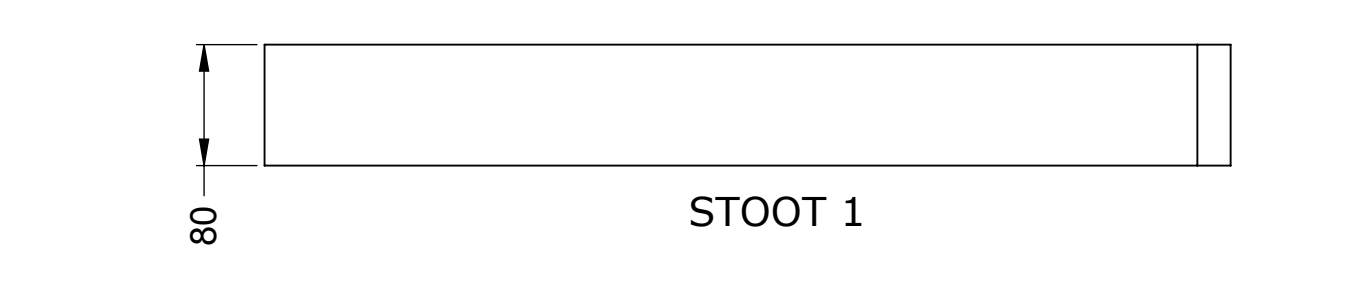
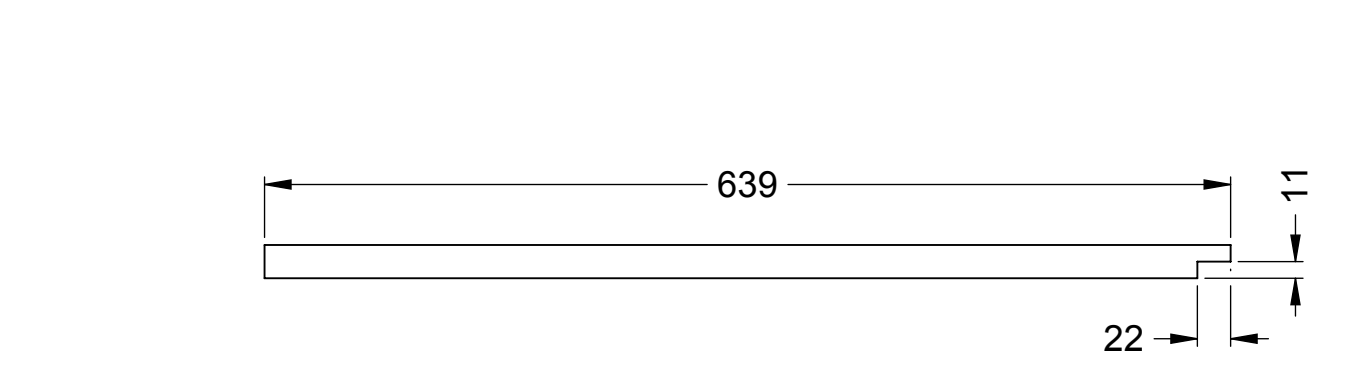
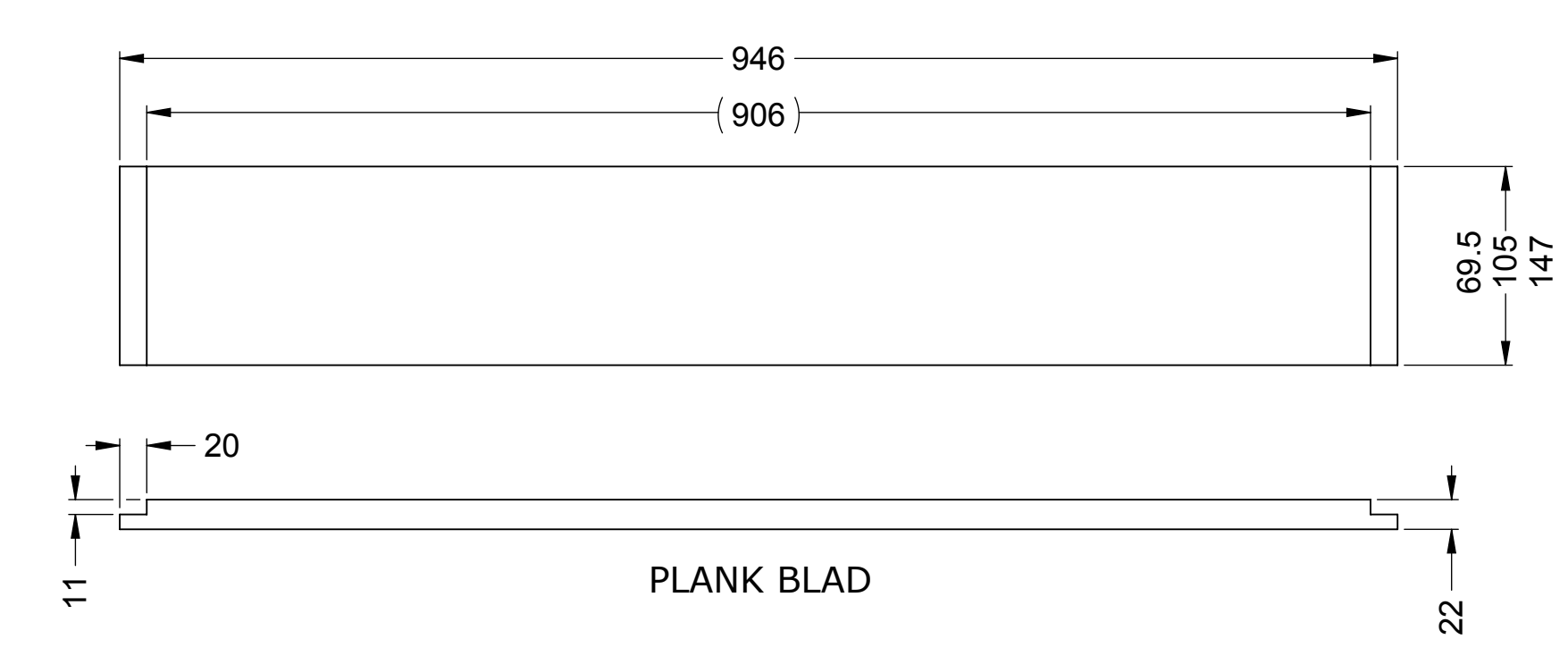
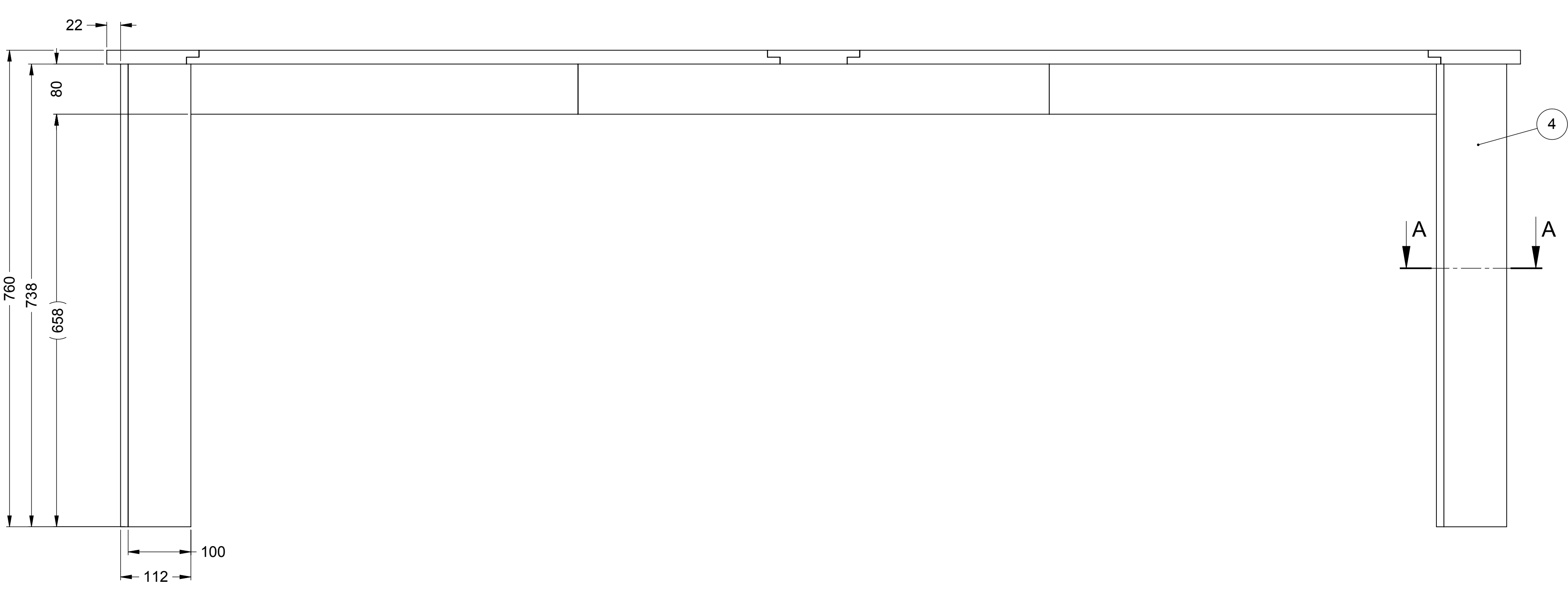
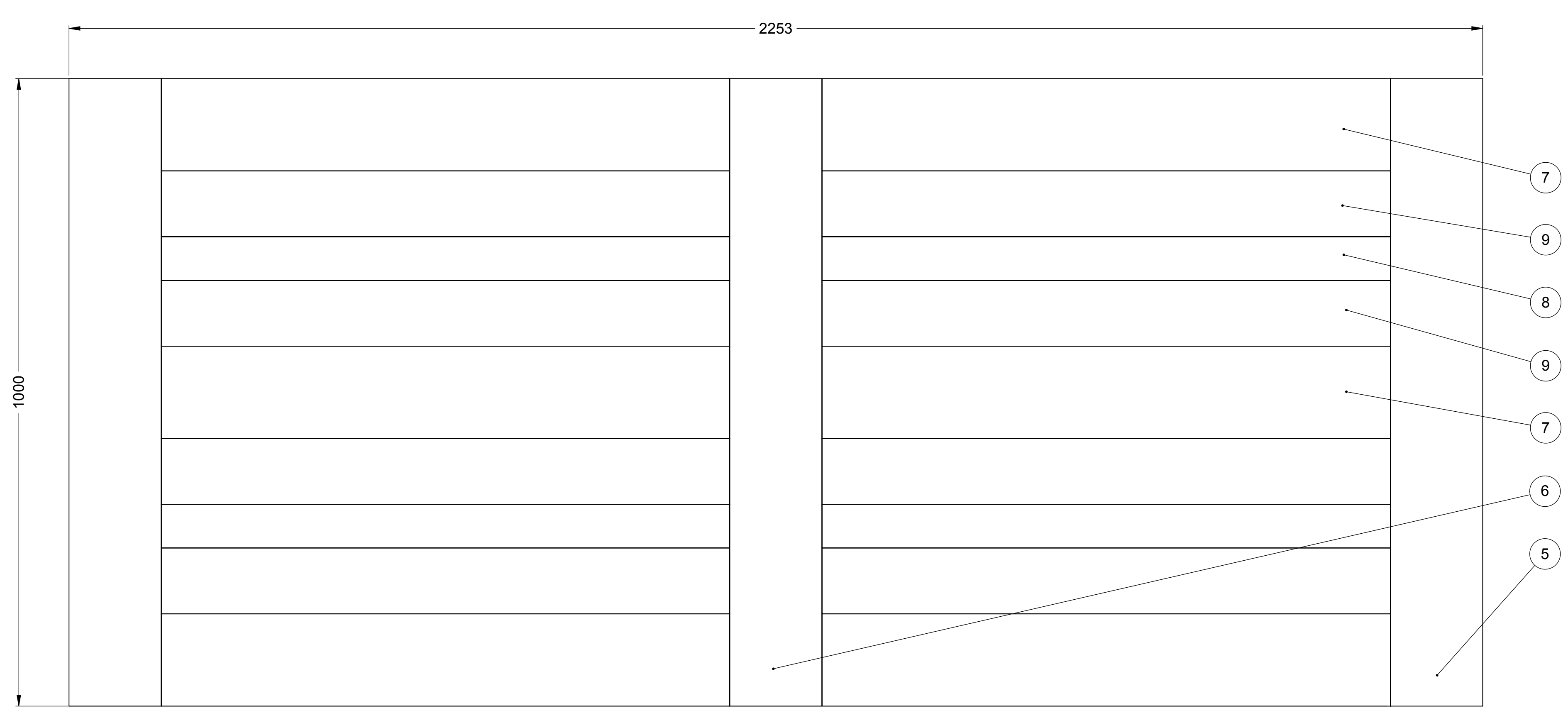
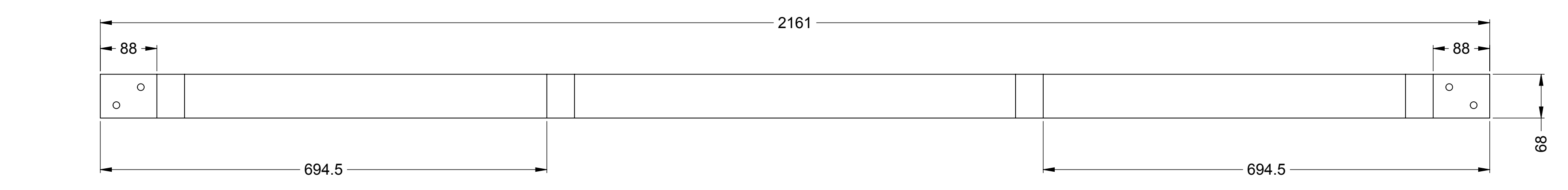
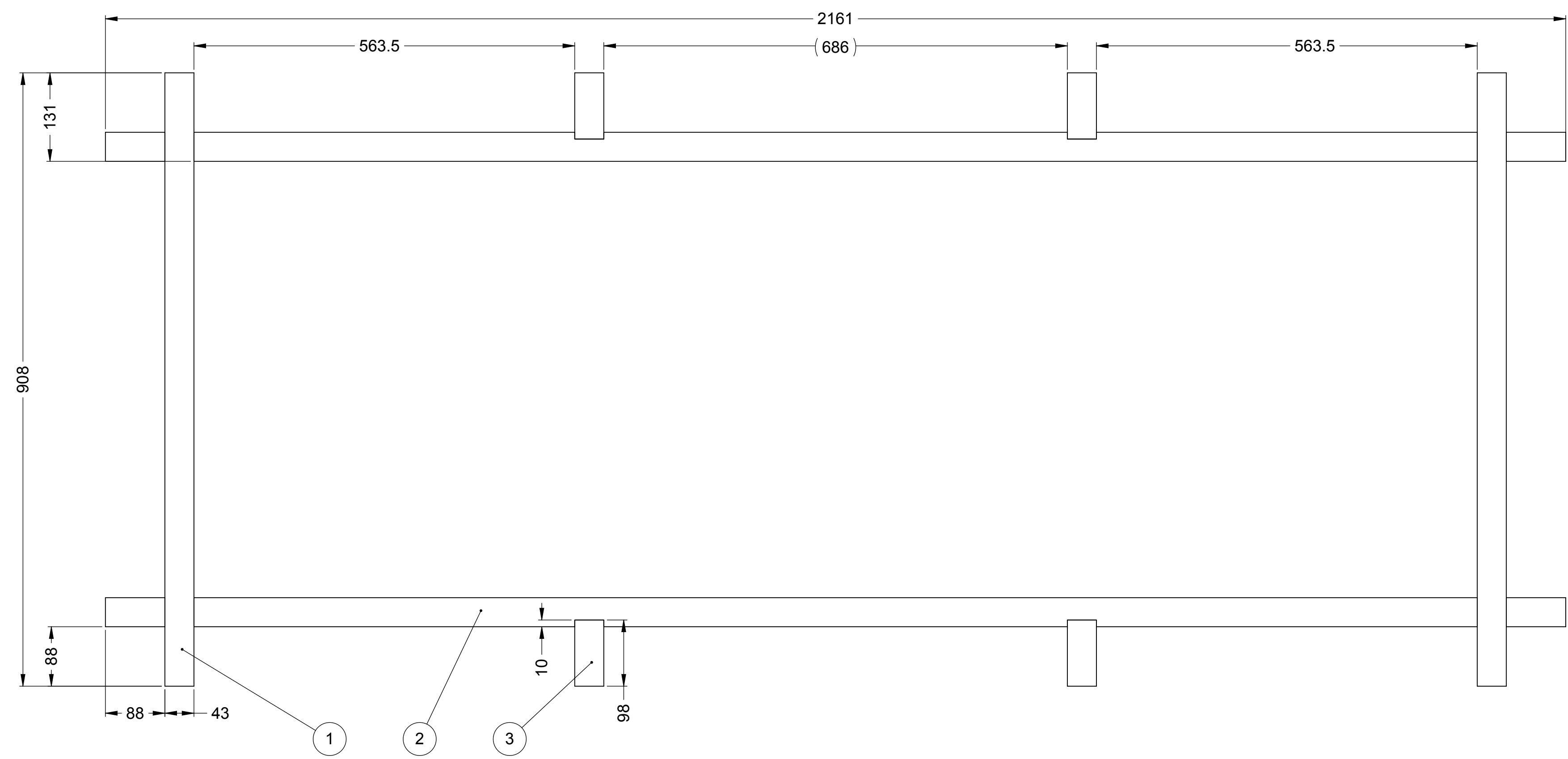

REV	DATE	CODE	DRAWN	APPR	SCALE	TITLE
					1:5	