



Thanks for downloading this model from Instructables.com
It was originally published on robives.com

If you enjoy paper engineering you'll love the membership package on robives.com. From just \$14.95 / £9.95 for a full year you get access to all sorts of exclusive member's content.

robives.com is a one man show relying on the support of members and shoppers. Thank you to all the people who have already become members, I literally couldn't run the site without you!

www.robives.com/membership

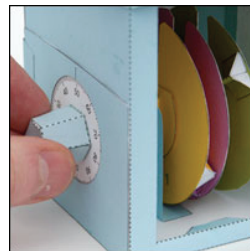

Just a few of the models free for members to download.

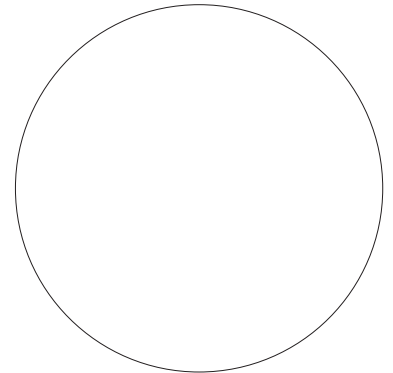
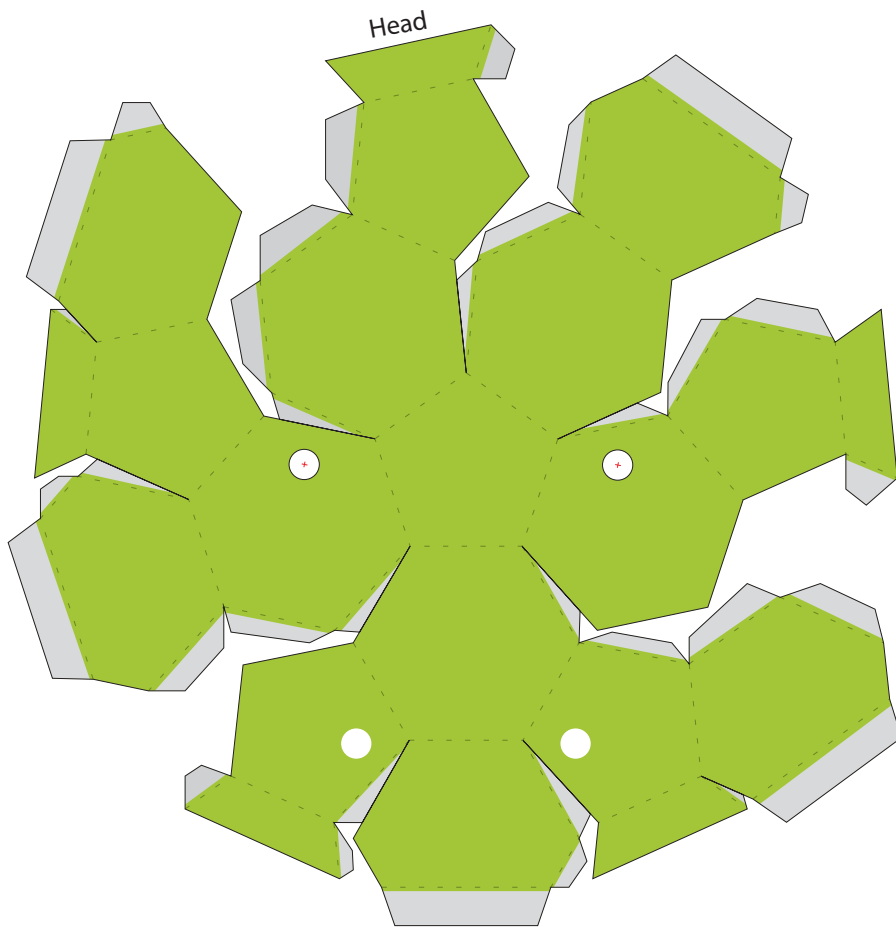

Head Disk

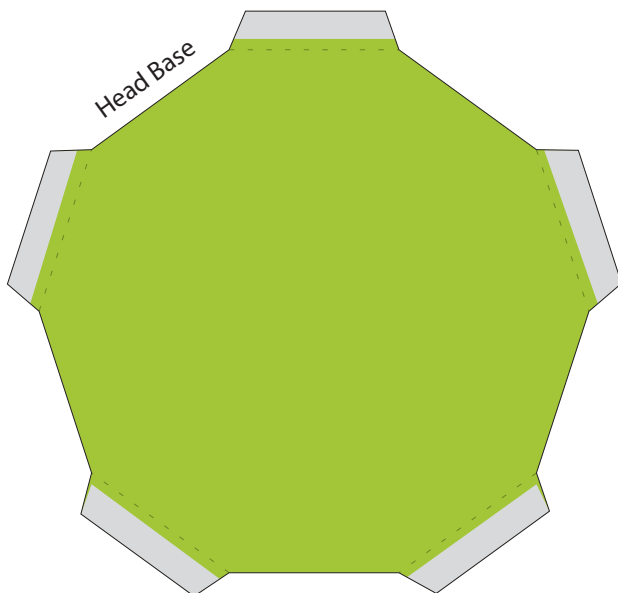

A poseable paper project to download and make.
Follow the instructions for construction at:
www.robives.com/blog/android

This Android robot is modified from work created and shared by Google and used according to terms described in the Creative Commons 3.0 Attribution License.

Rob Ives / robives.com



robives
.com

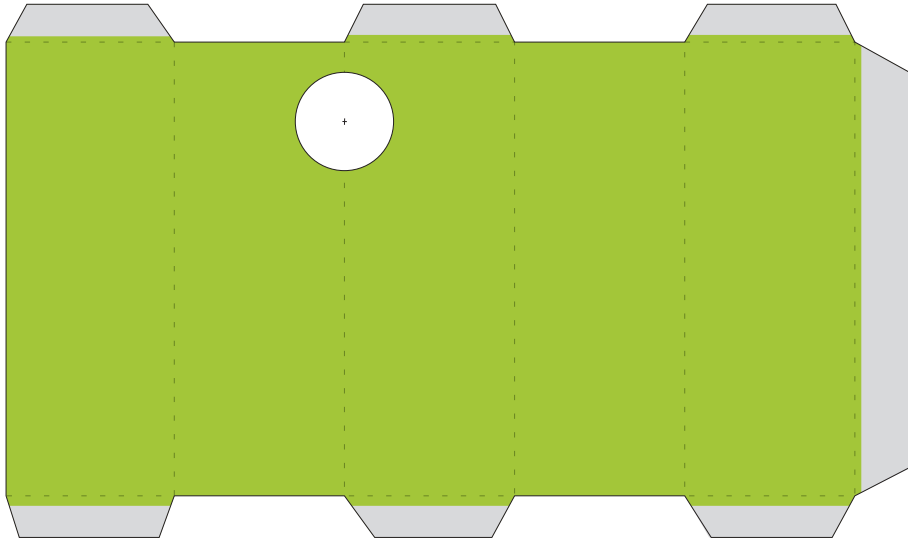

Body sides

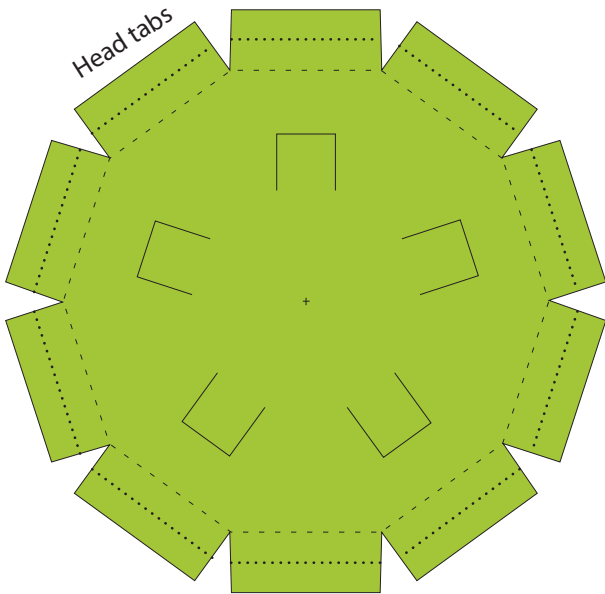
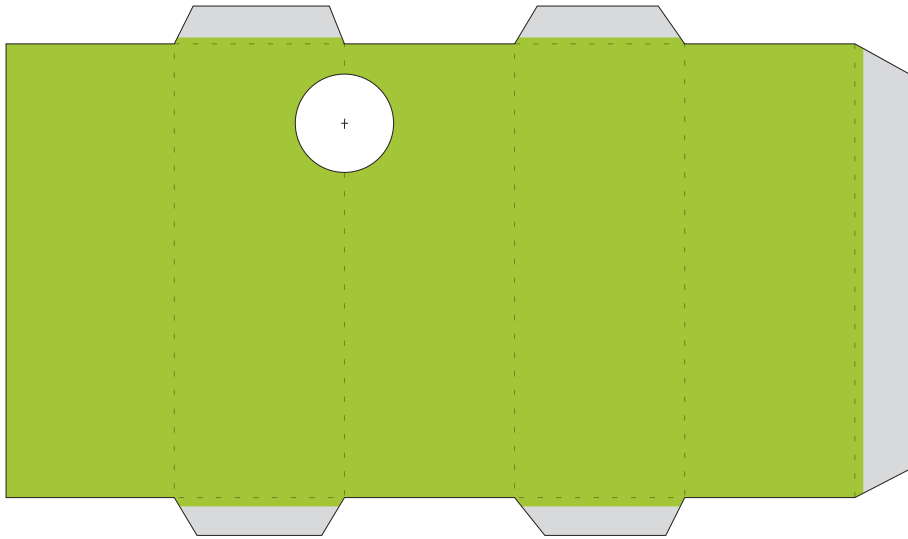

Head tabs

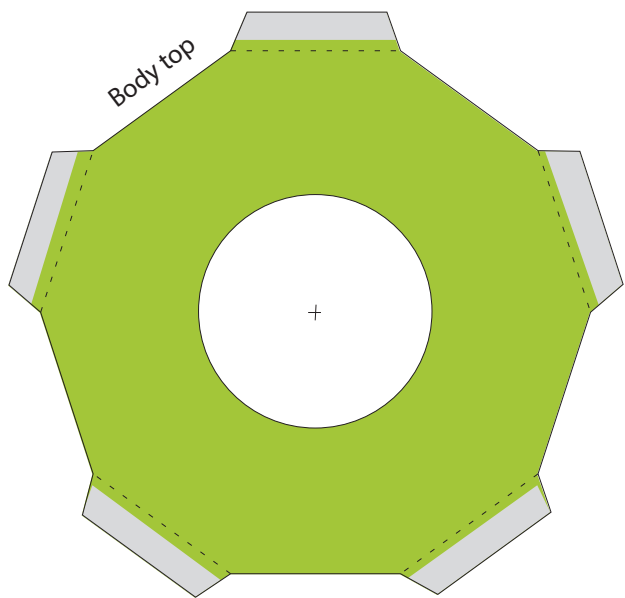

Body top

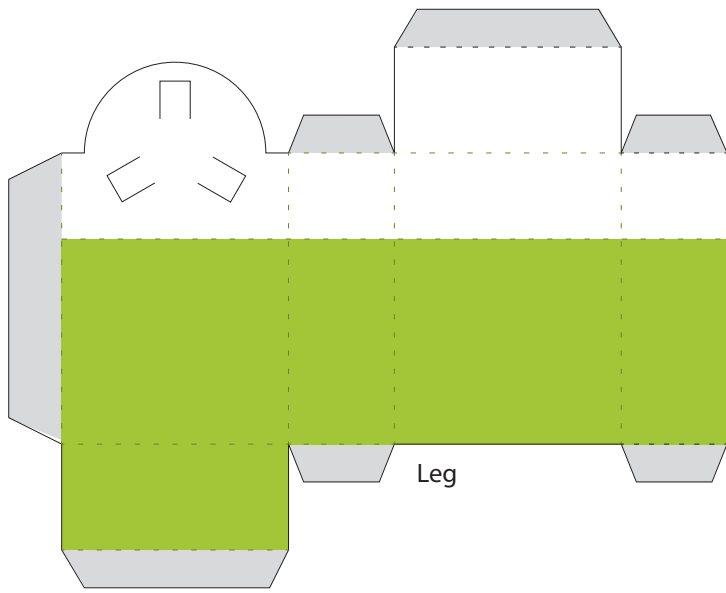

Leg

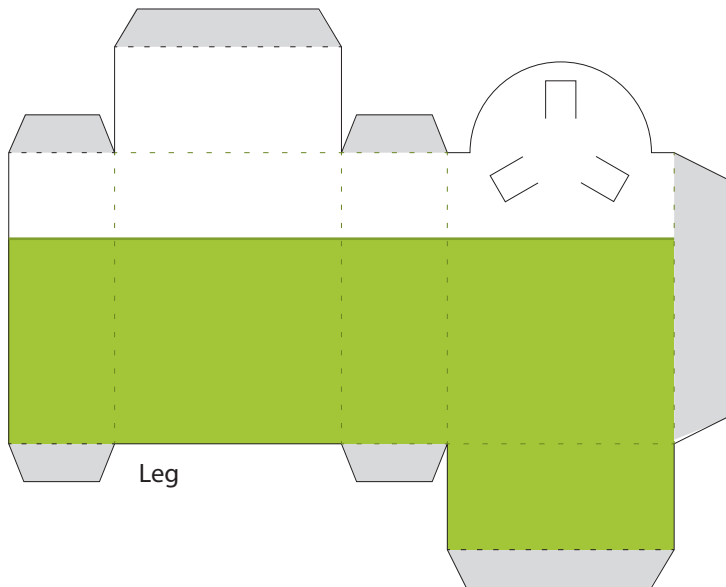

Leg

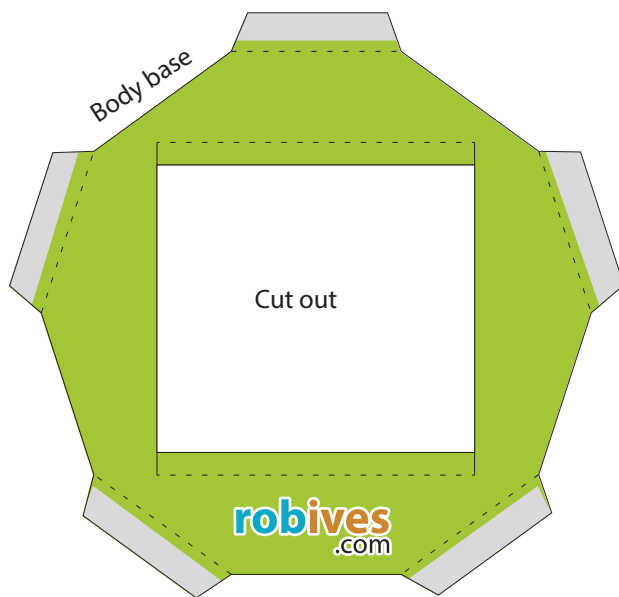

Body base

Cut out

robives.com

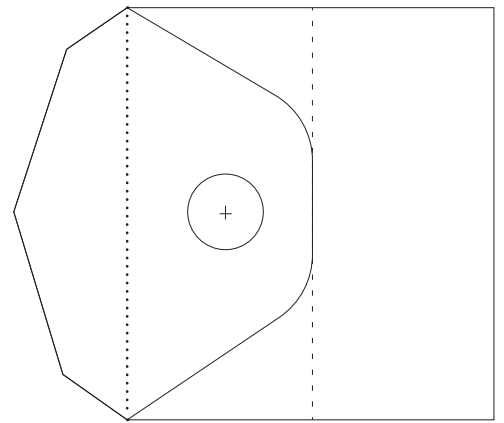

Leg support

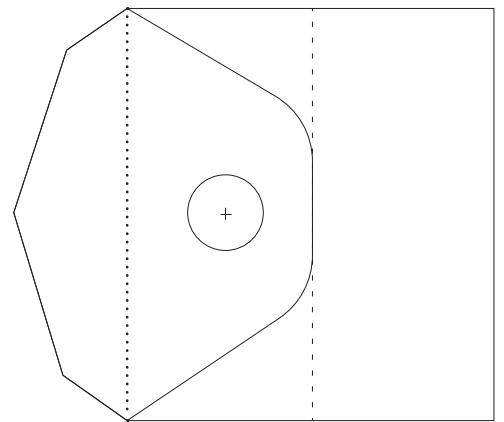

Leg tab covers

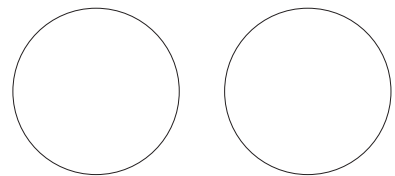

Leg joiner

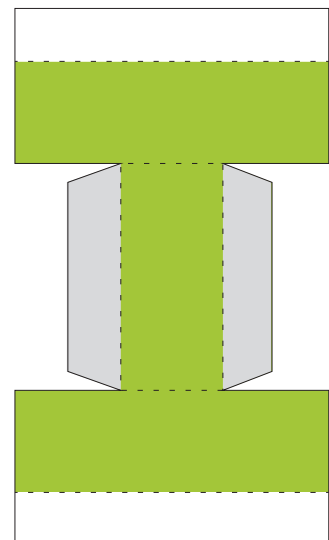

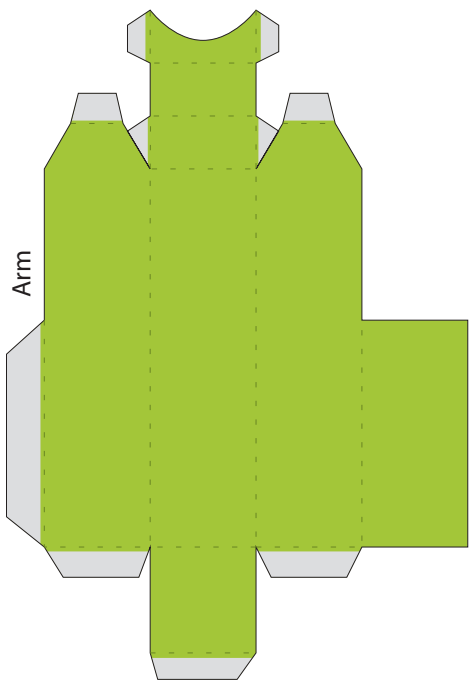
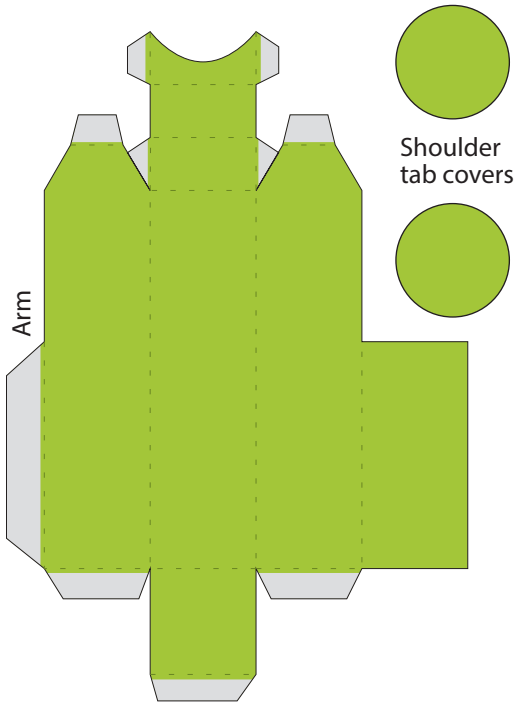

Shoulders

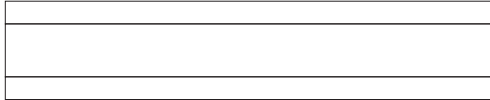
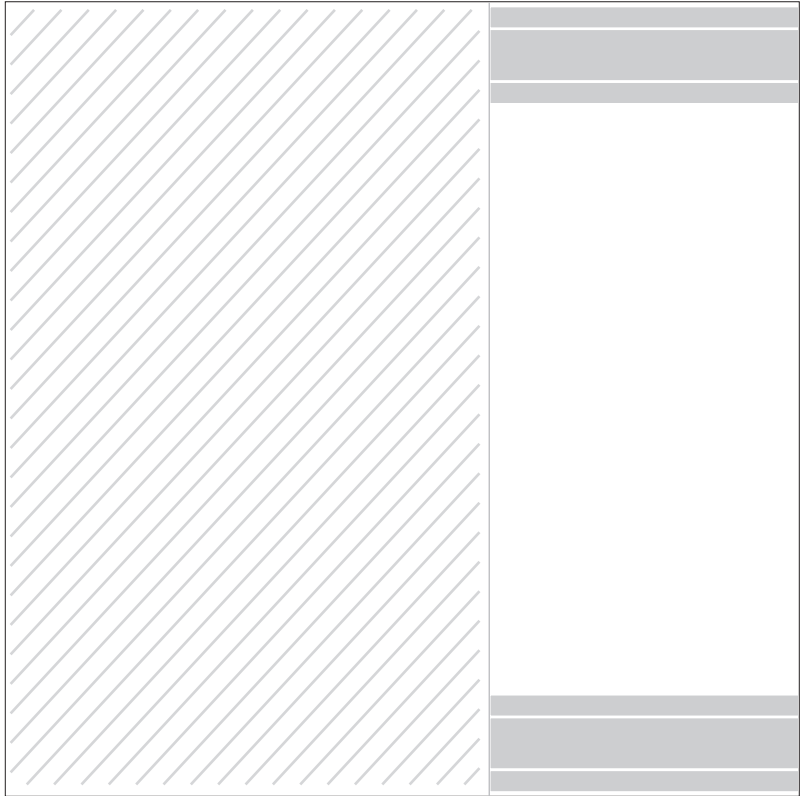

Arm strips

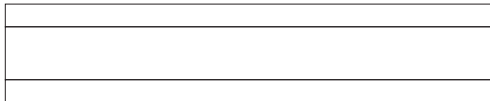

Shoulder tab covers



Arm tabs



Shoulder Ends

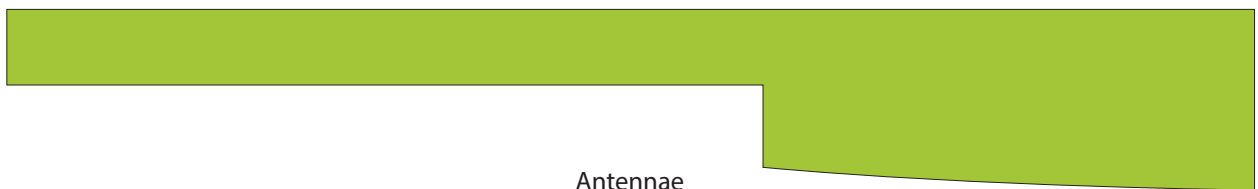

Antennae

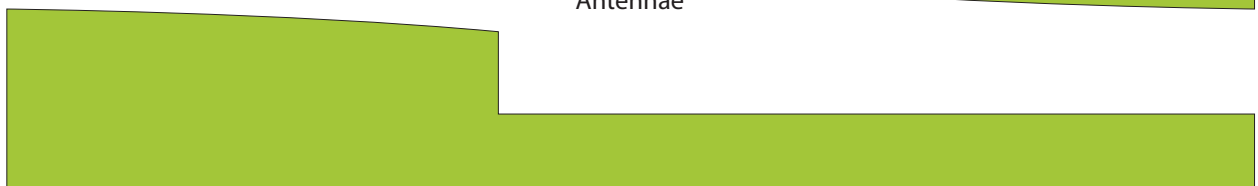

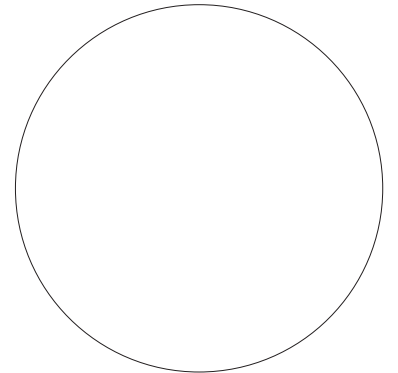
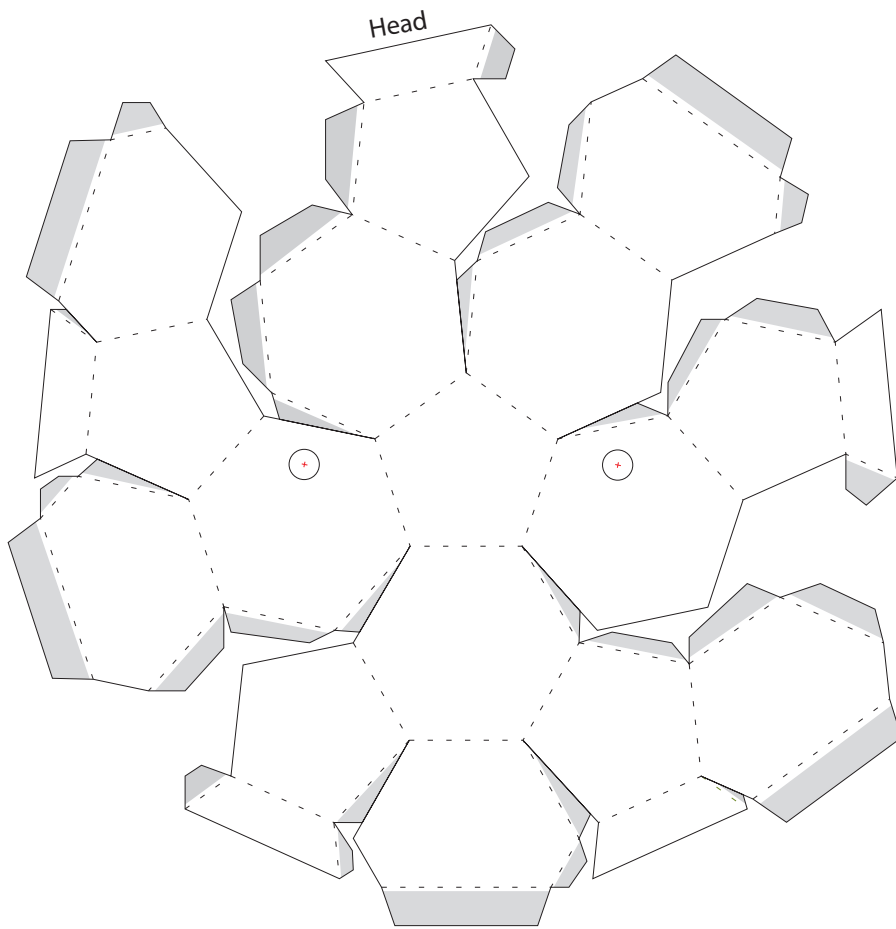

Head Disk

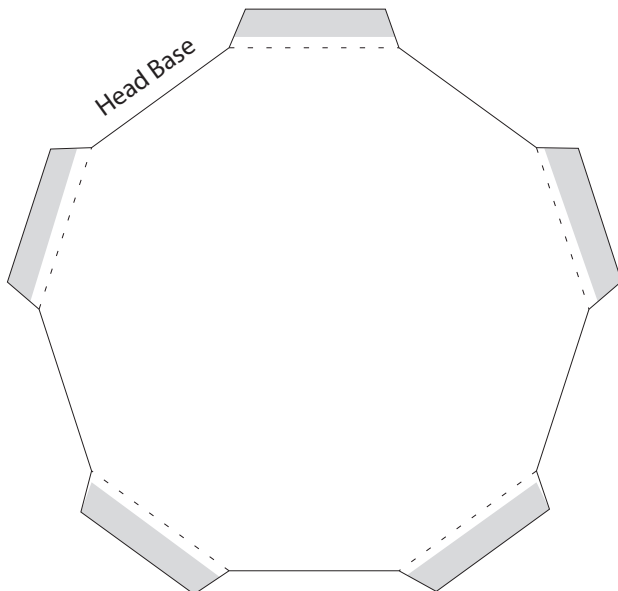

A poseable paper project to download and make.
Follow the instructions for construction at:
www.robives.com/blog/android

This Android robot is modified from work created and shared by Google and used according to terms described in the Creative Commons 3.0 Attribution License.

Rob Ives / robives.com



robives
.com

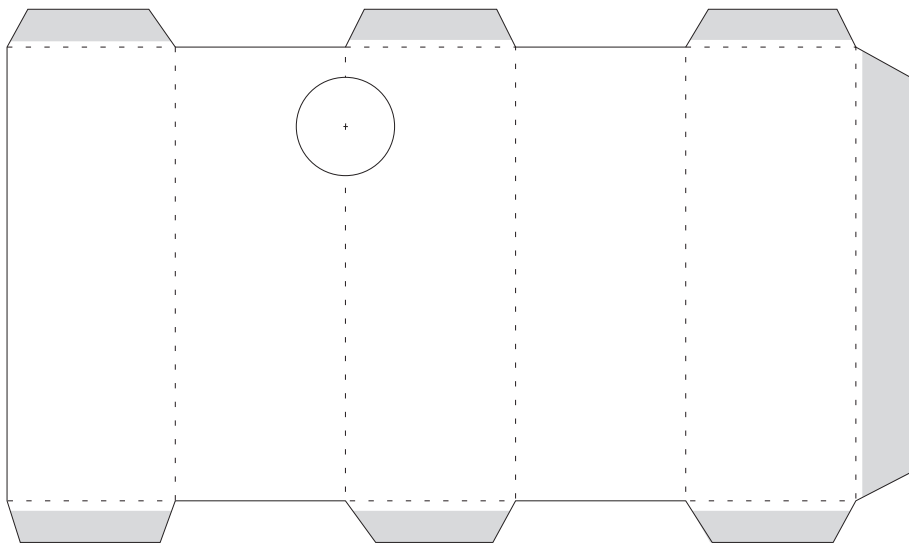

Body sides

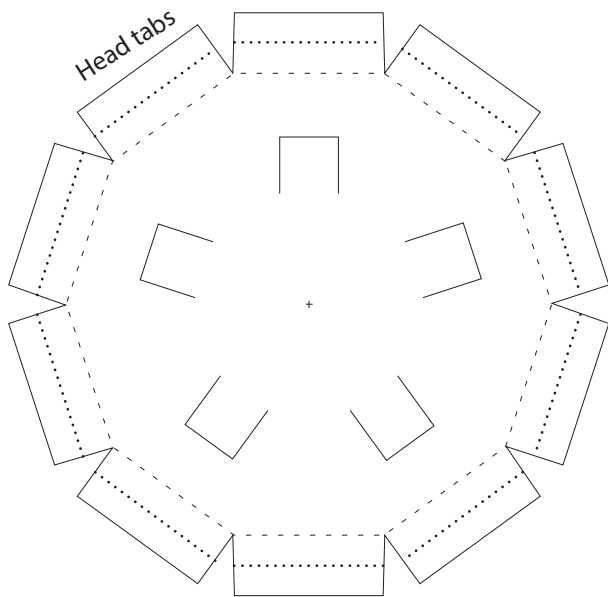
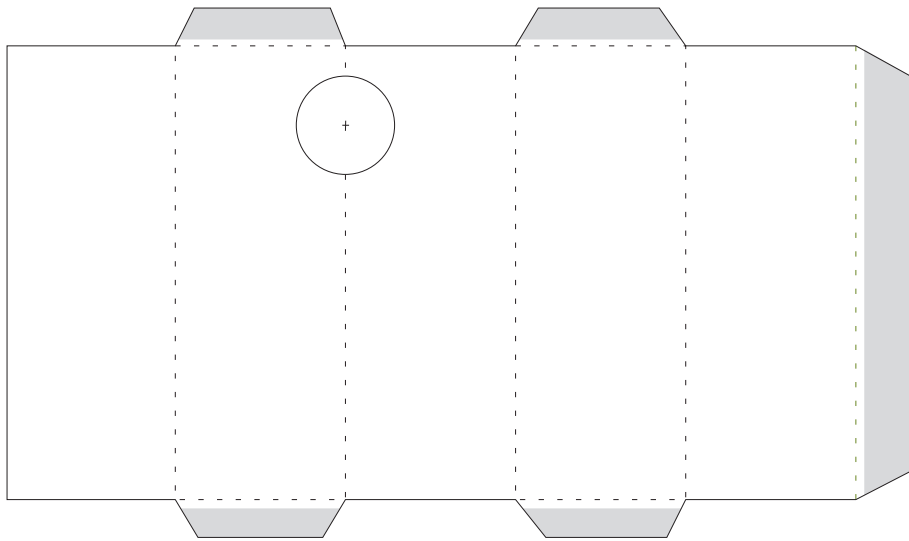

Head tabs

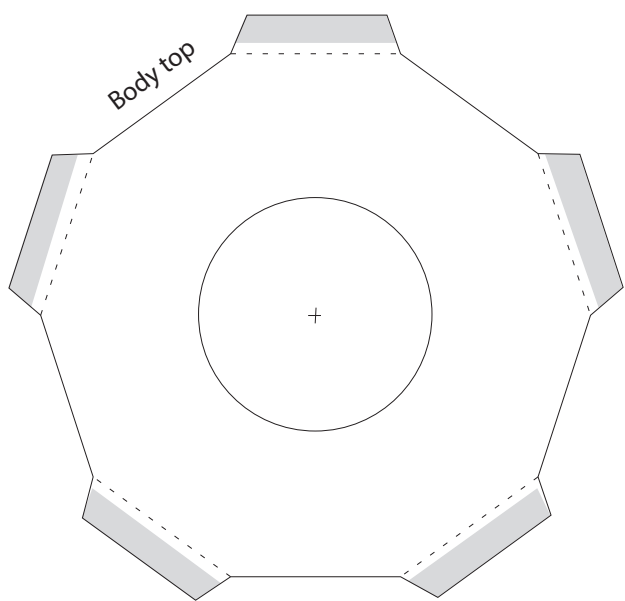

Body top

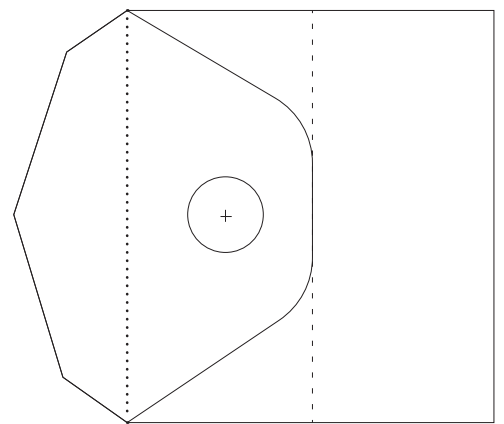
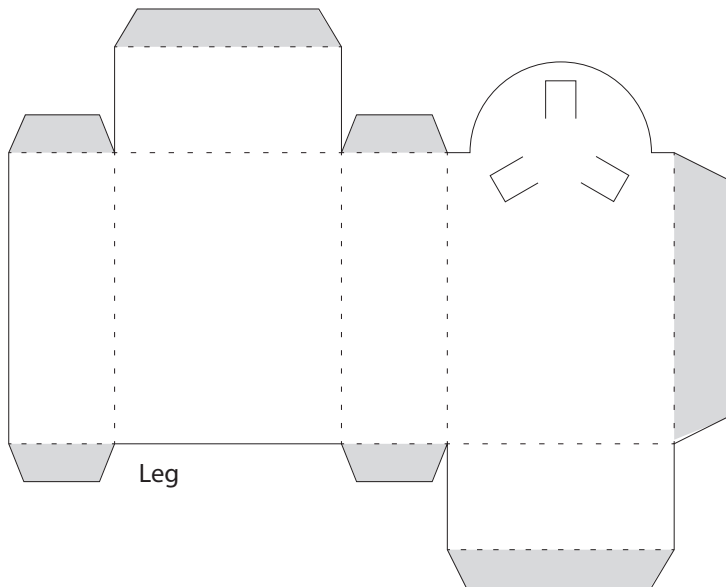
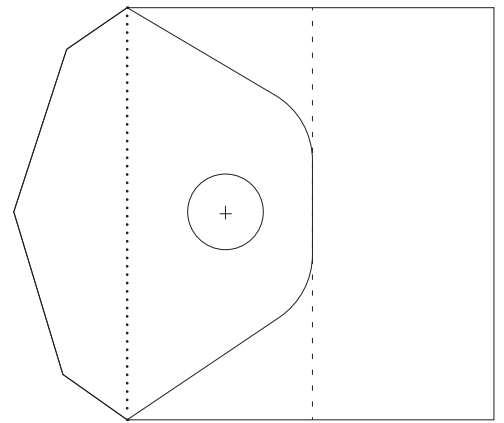
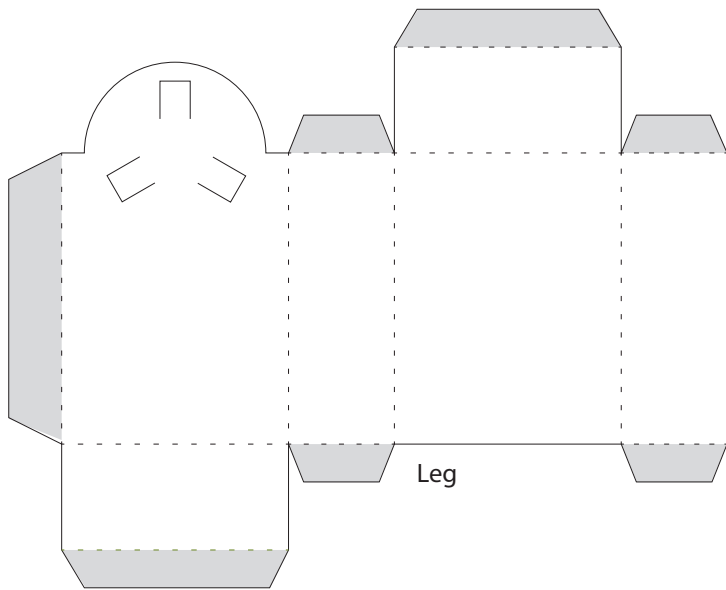

Leg tab covers

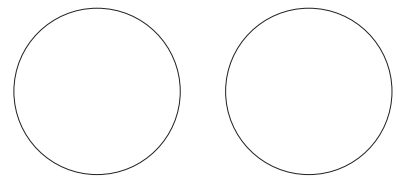

Leg joiner

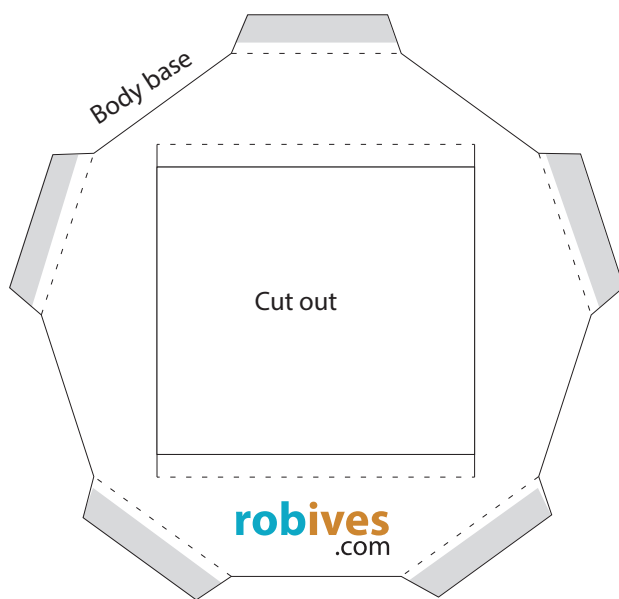
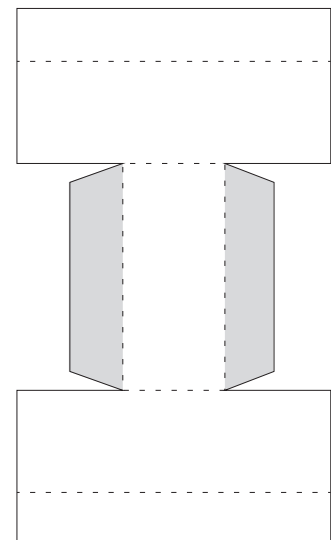

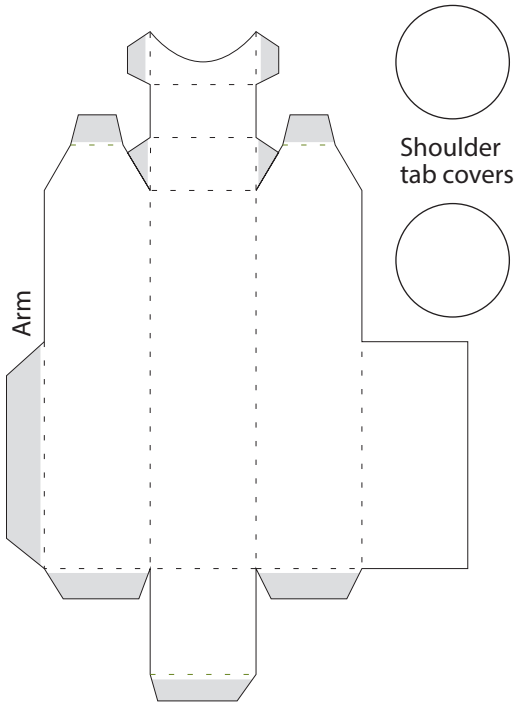

Shoulder
tab covers

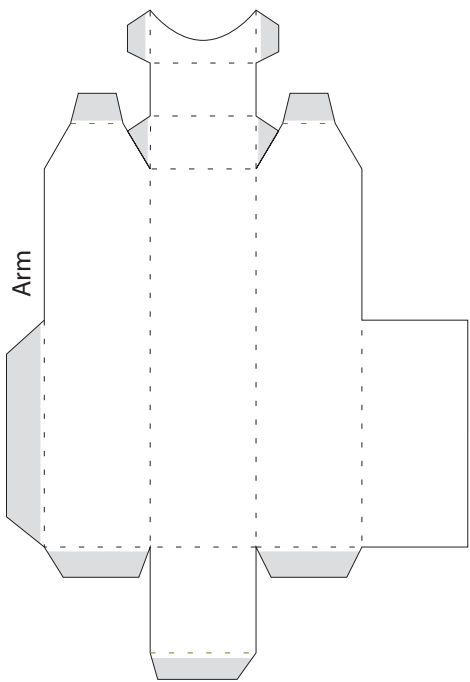

Shoulders

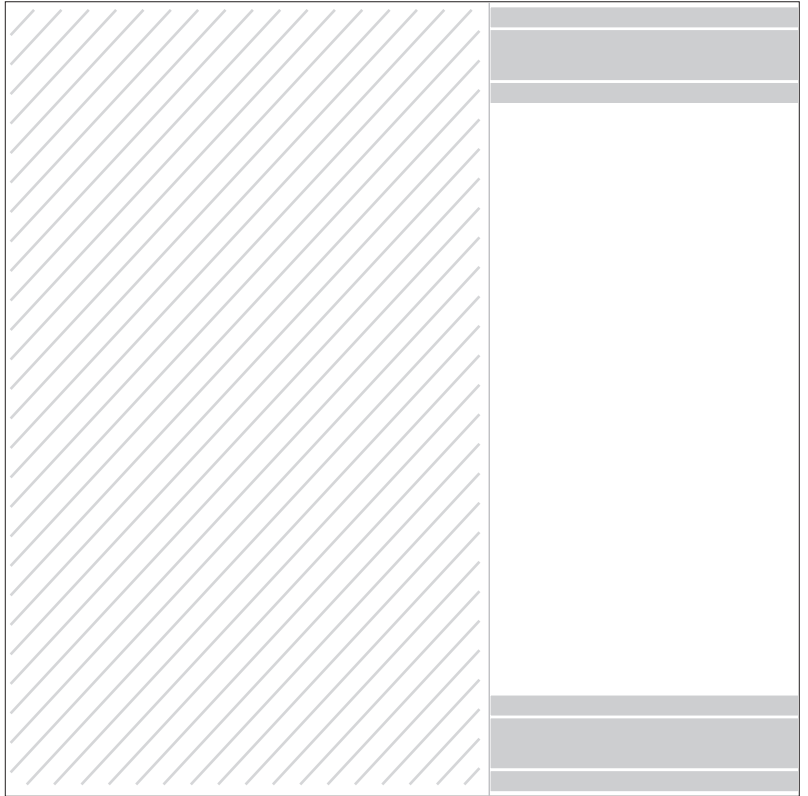

Arm strips



Shoulder
tab covers

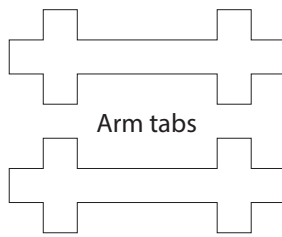

Arm tabs

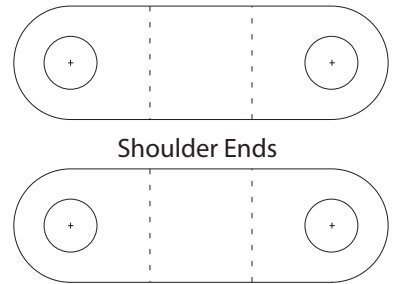

Shoulder Ends

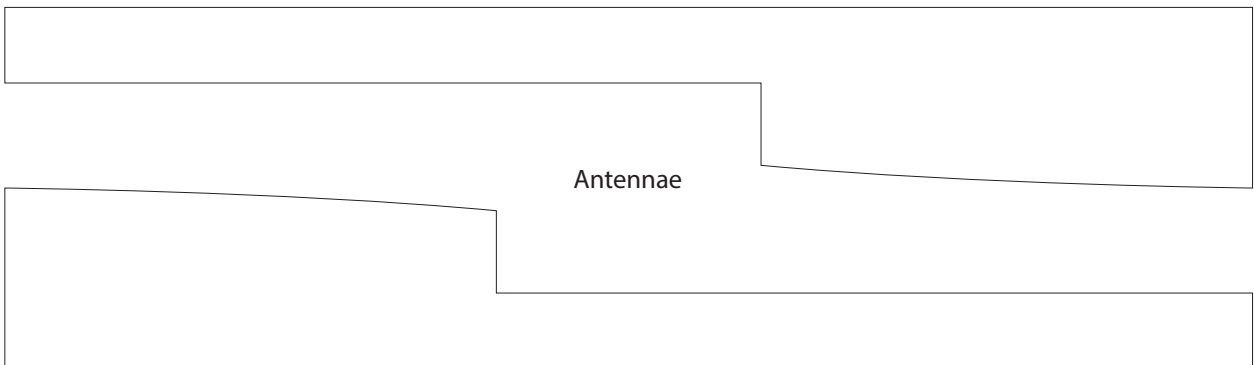

Antennae