

1

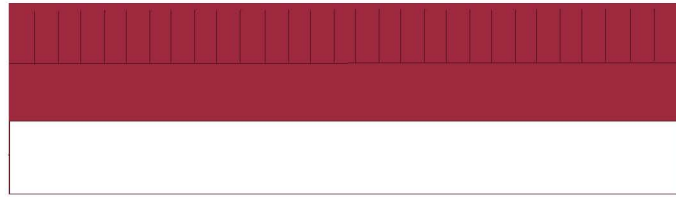

2

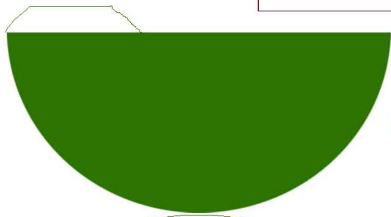

3

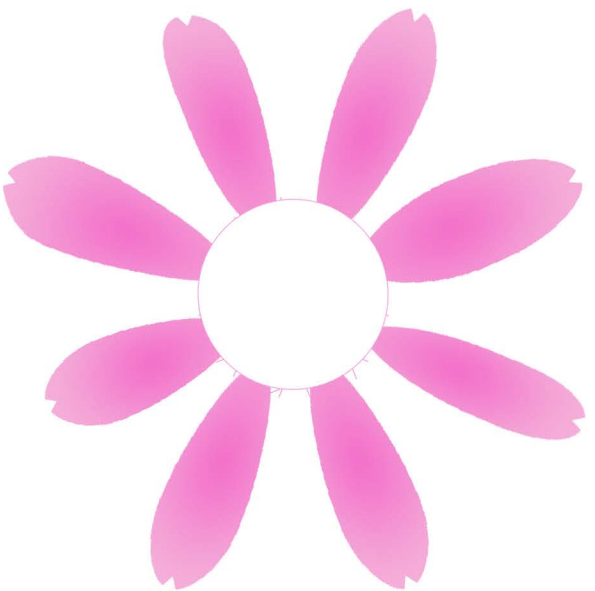
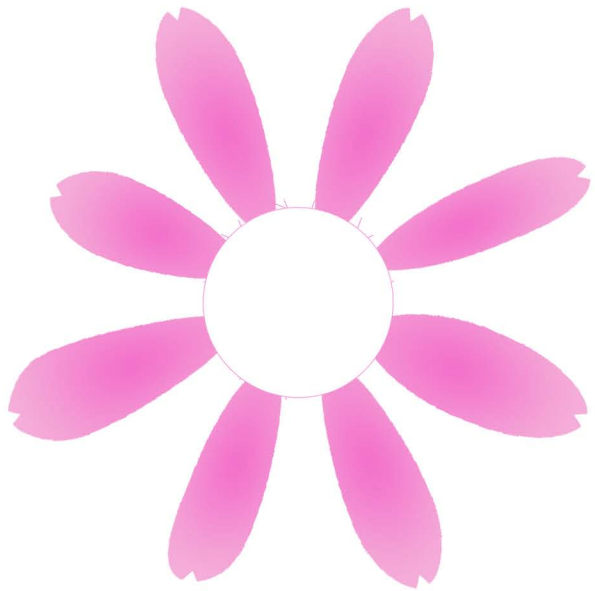
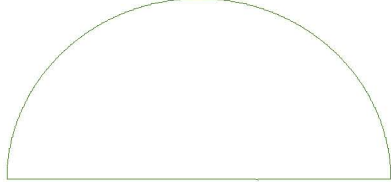

4



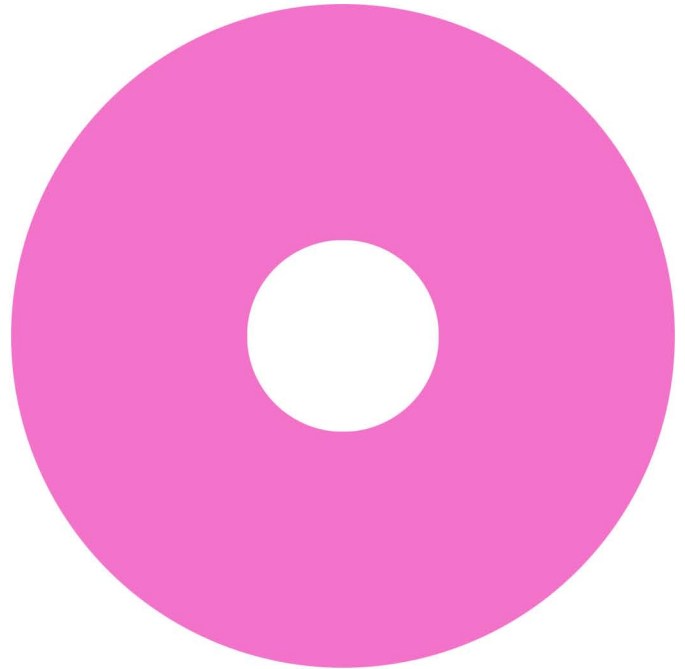
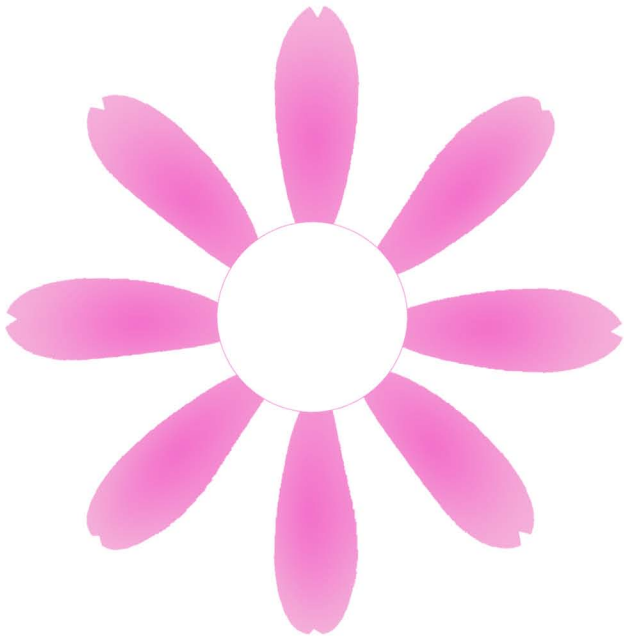
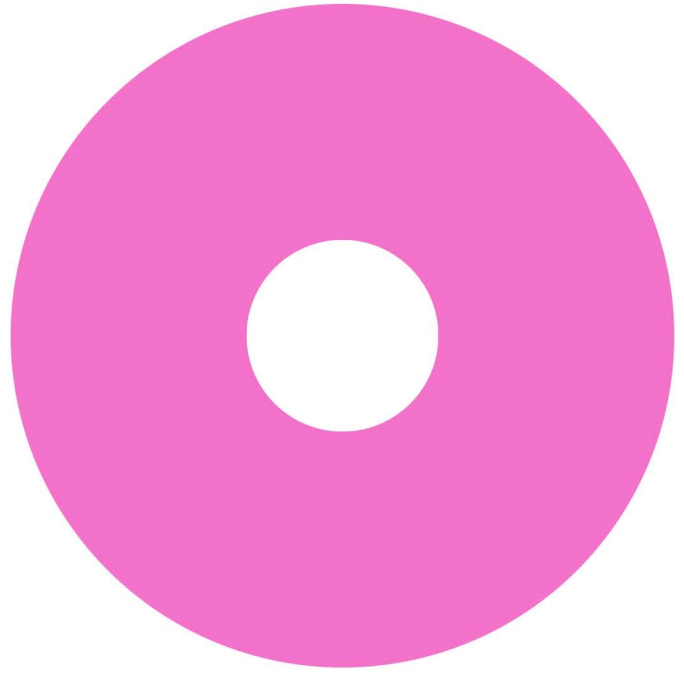
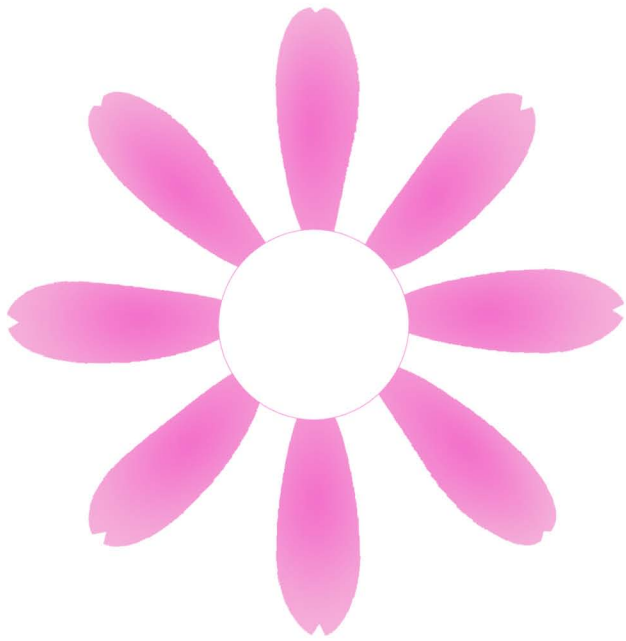

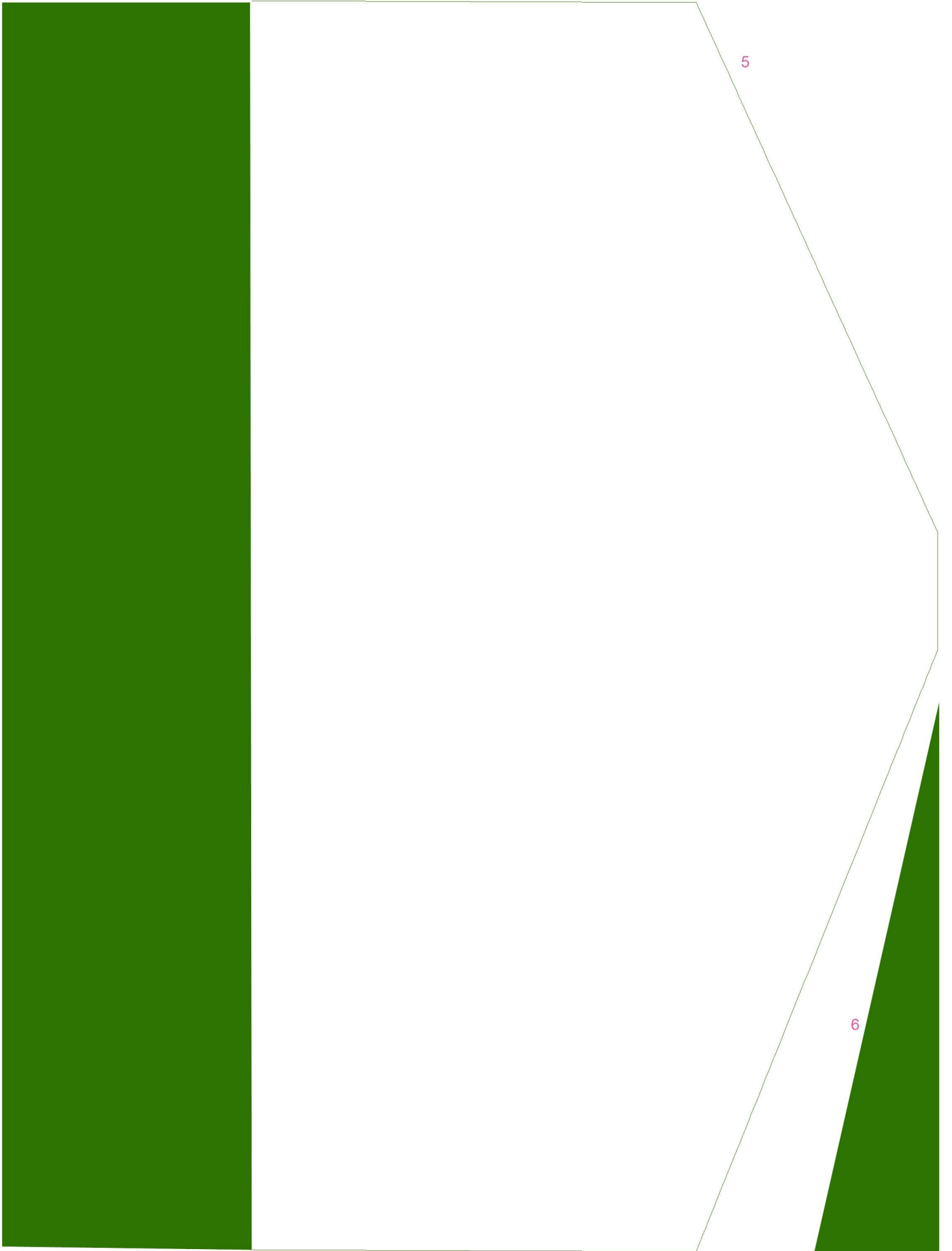

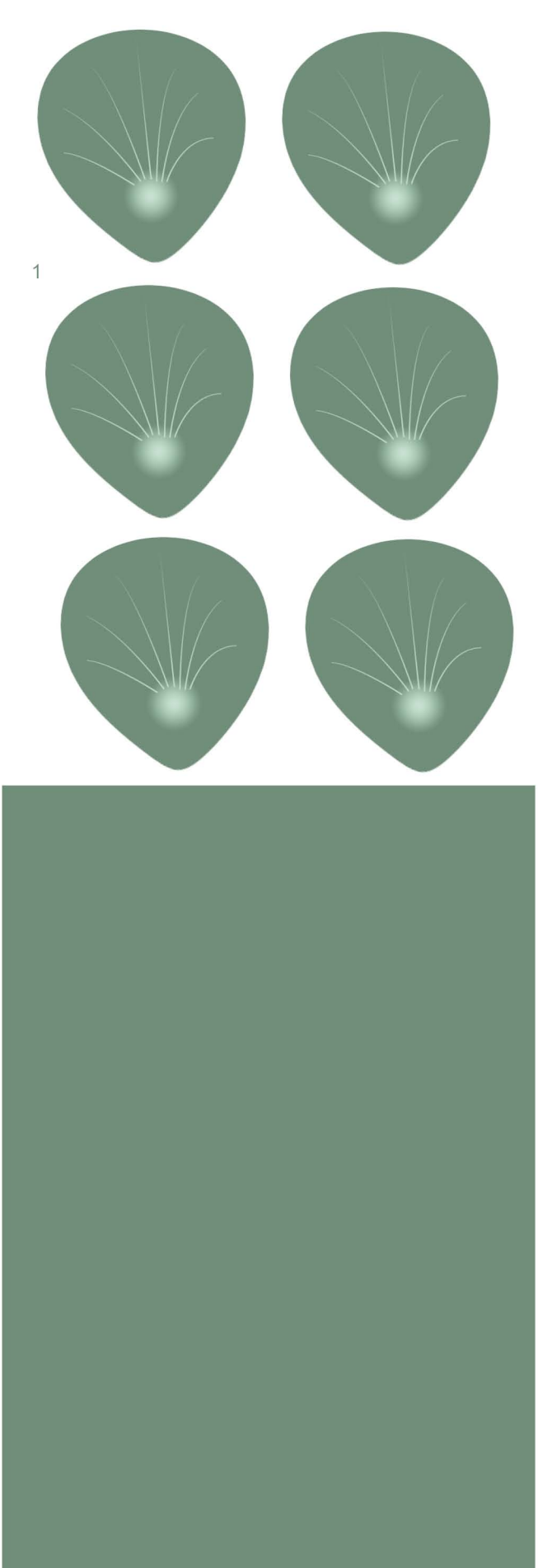
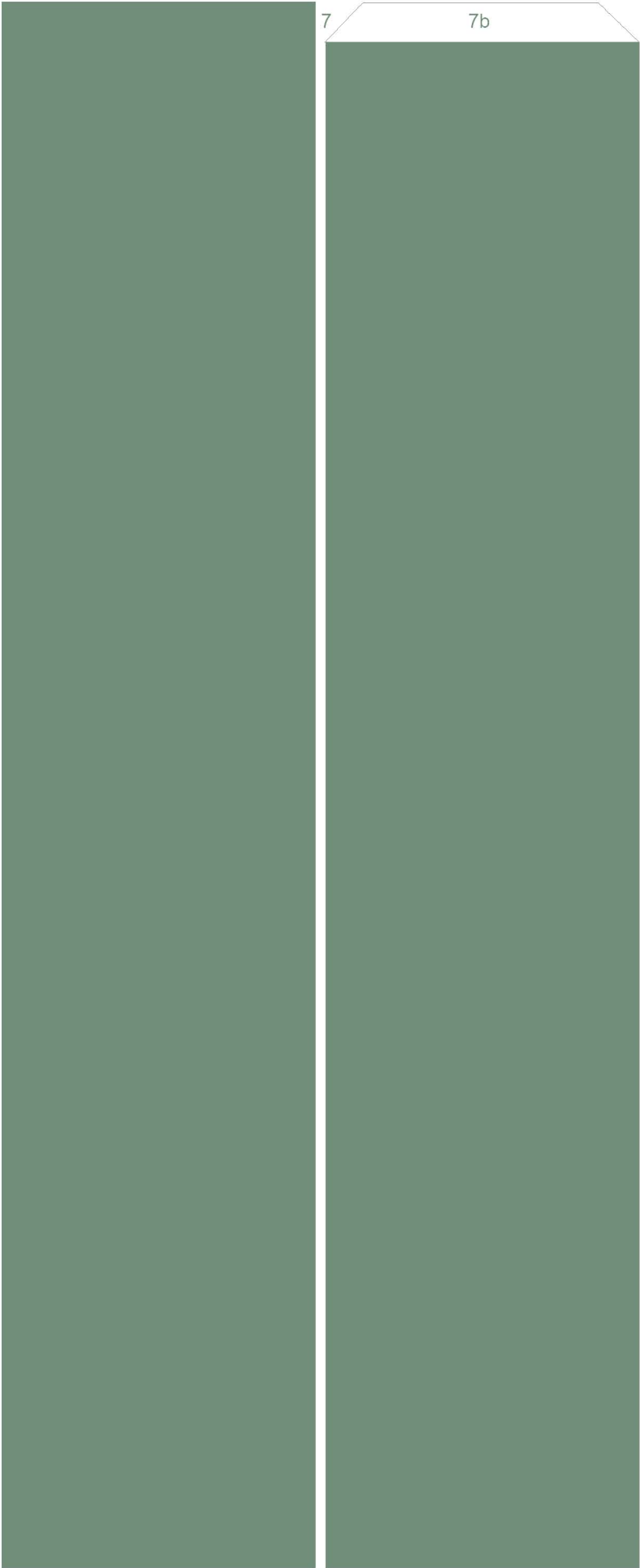

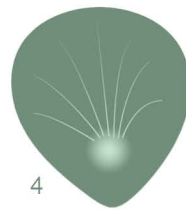
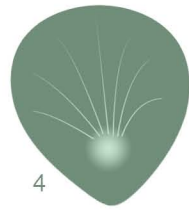
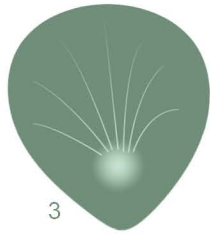
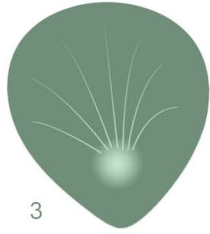
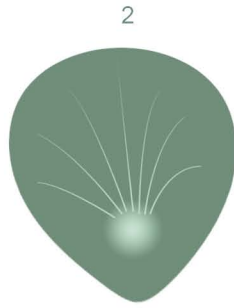
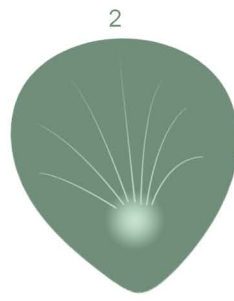
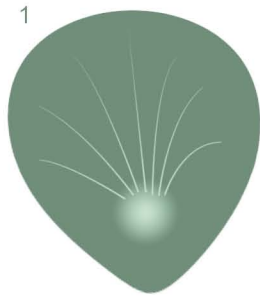
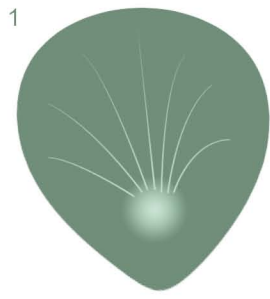

6

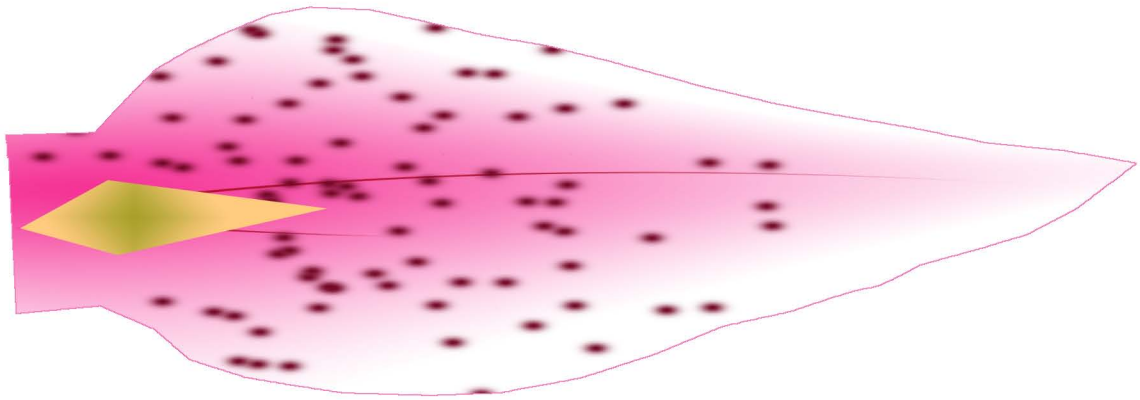

1

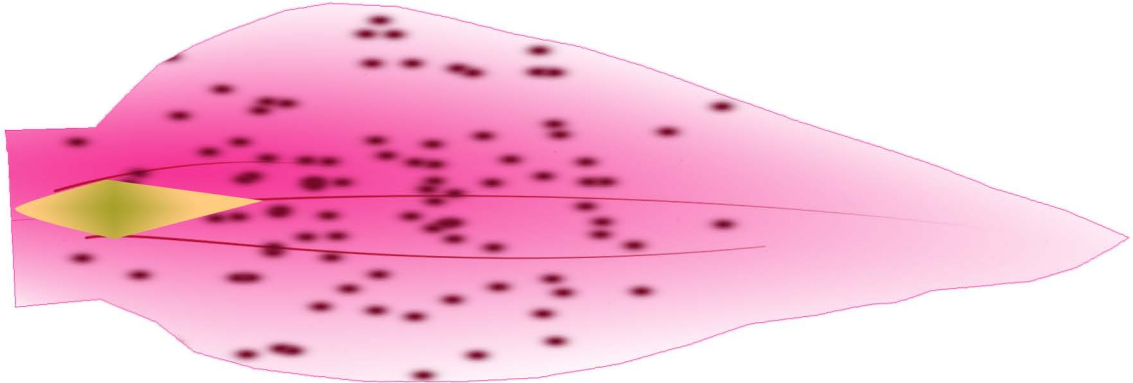

2

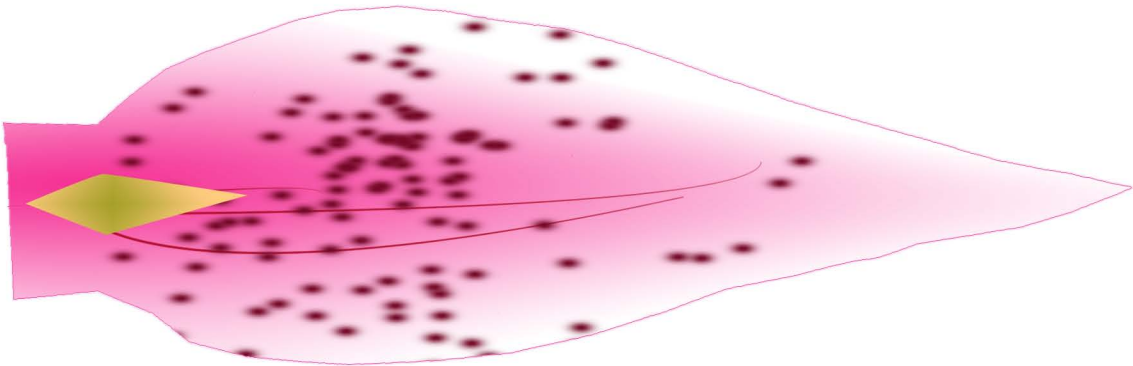

3

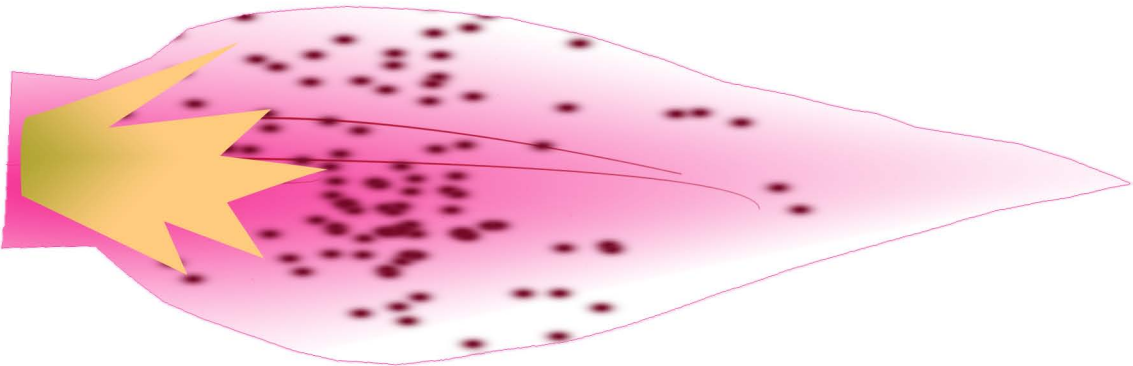

3b



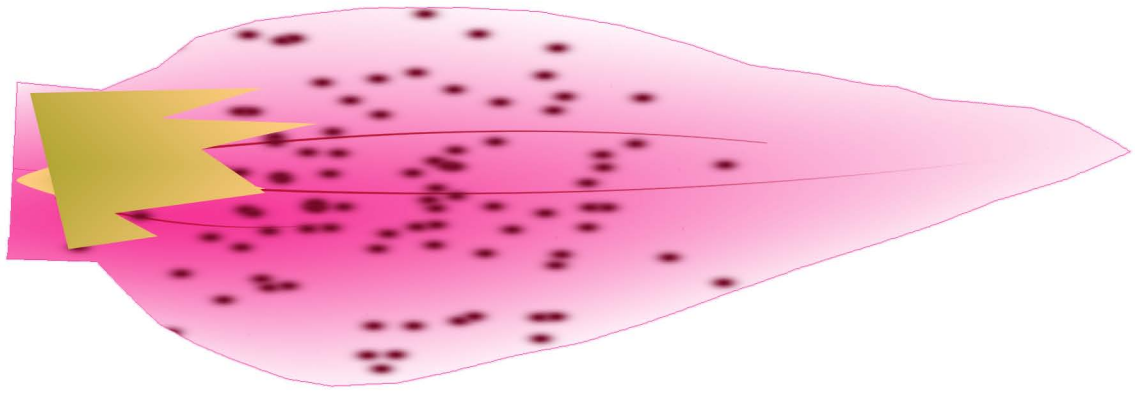

2b

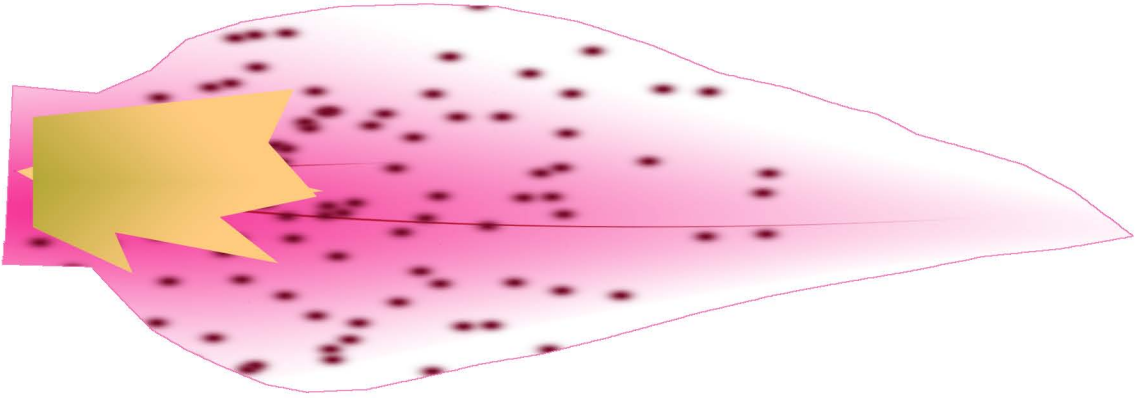

1b

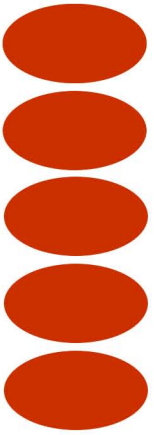

7



8

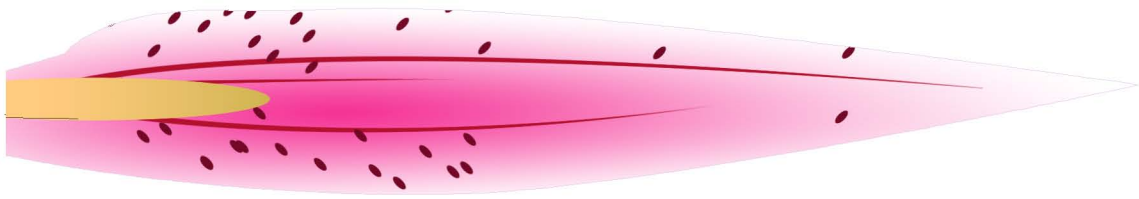

4



5

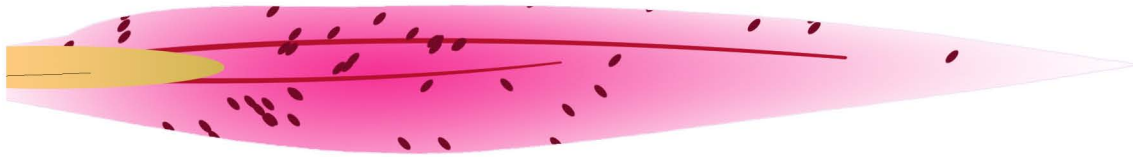

6

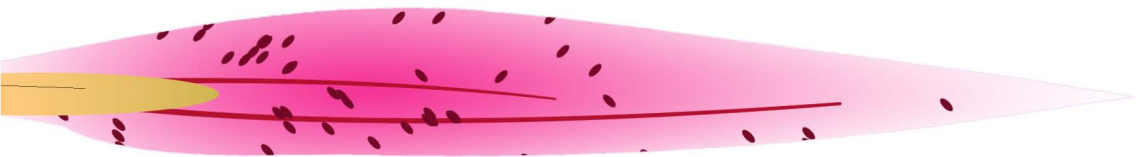

4b

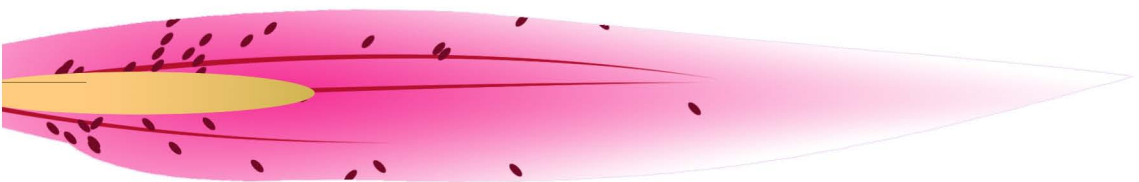

5b

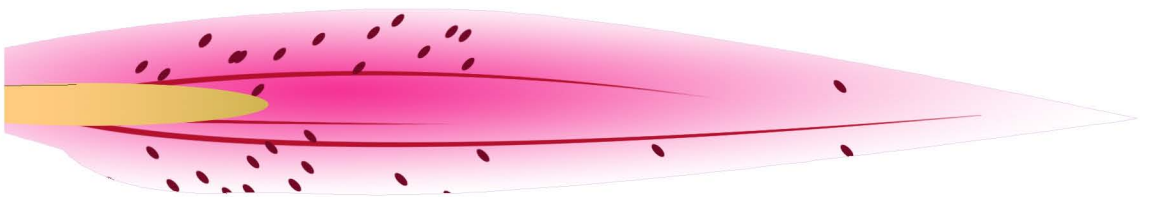

6b

9

11

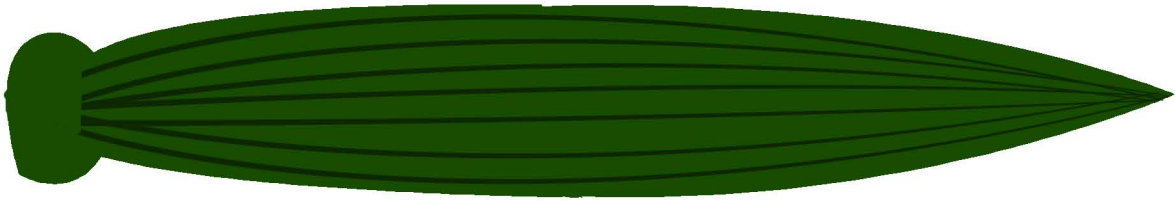

10

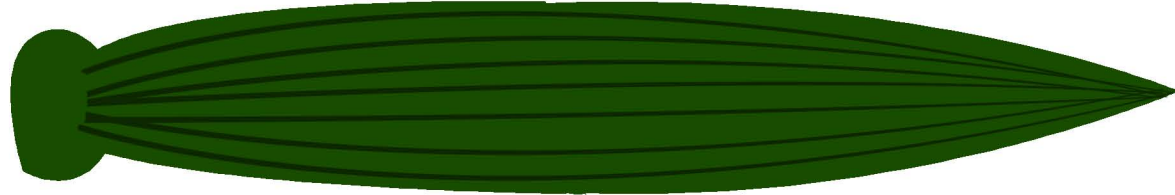

10

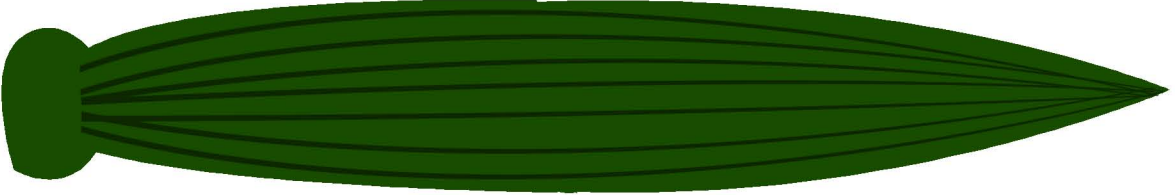

10

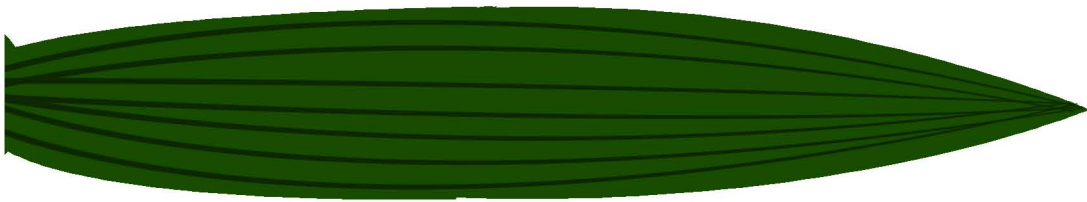

10b

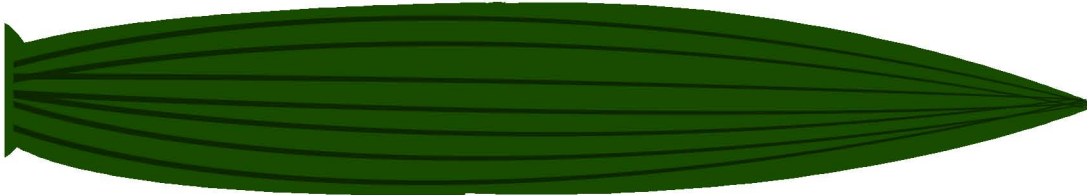

10b

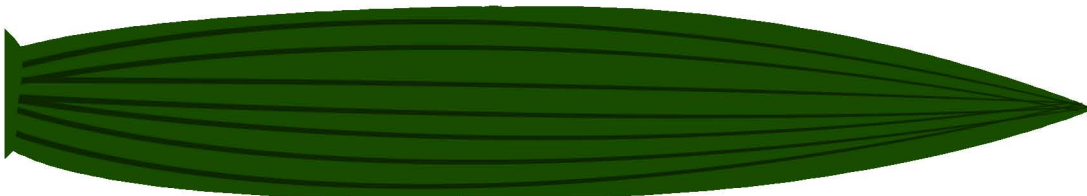

10b

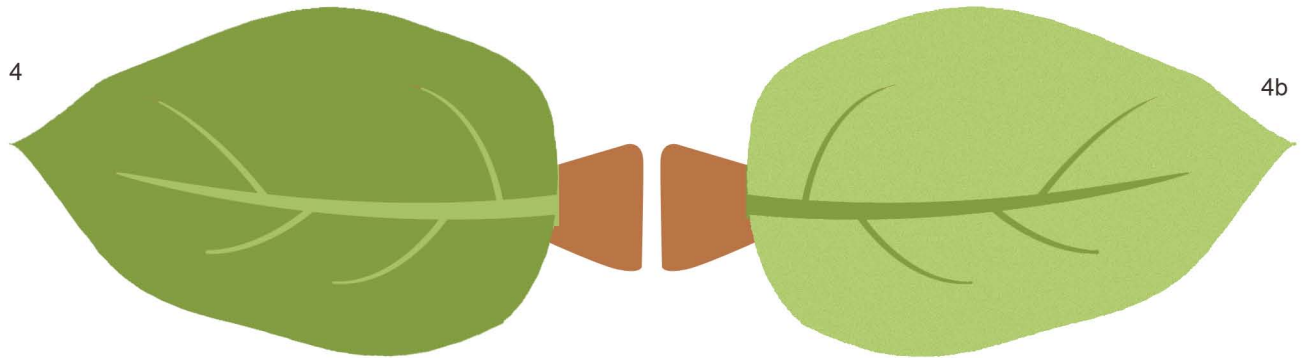
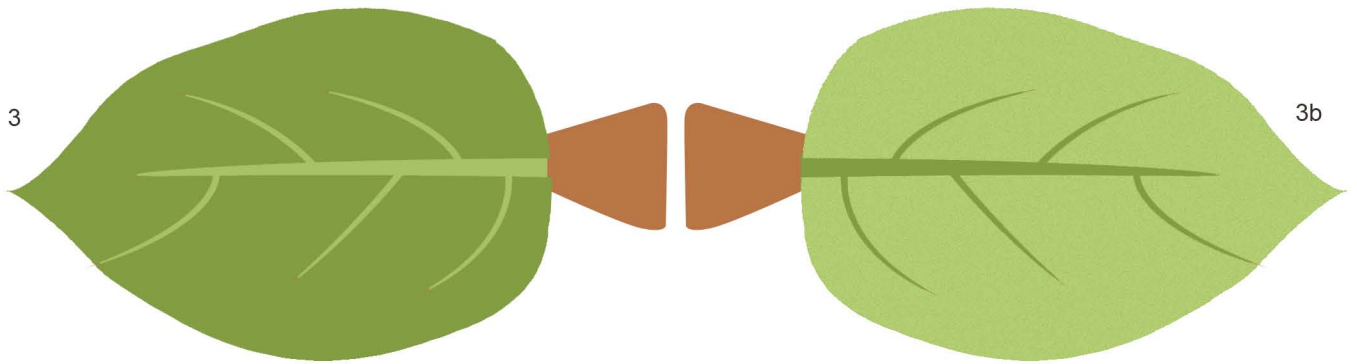
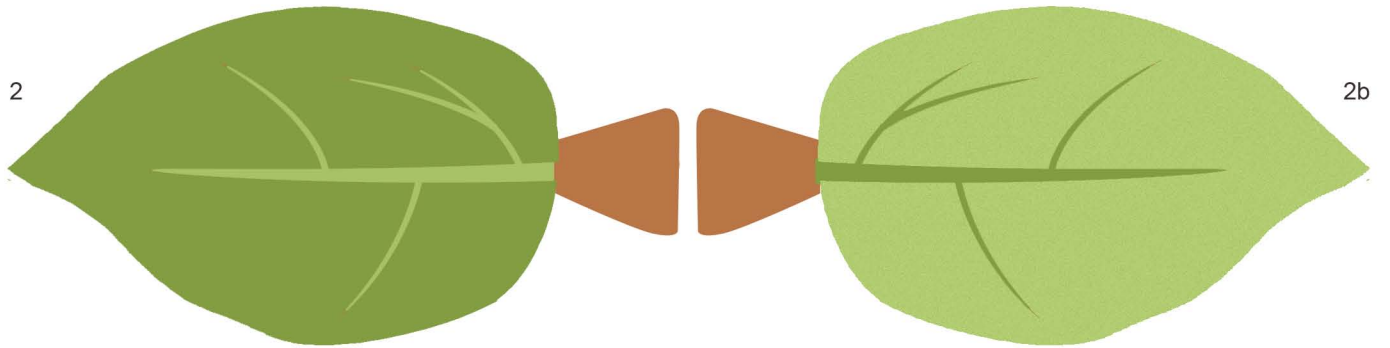
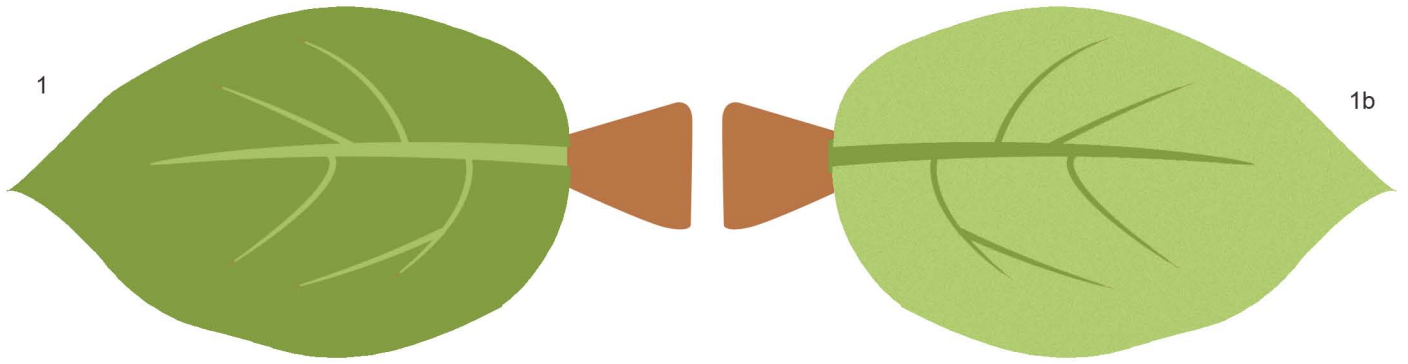

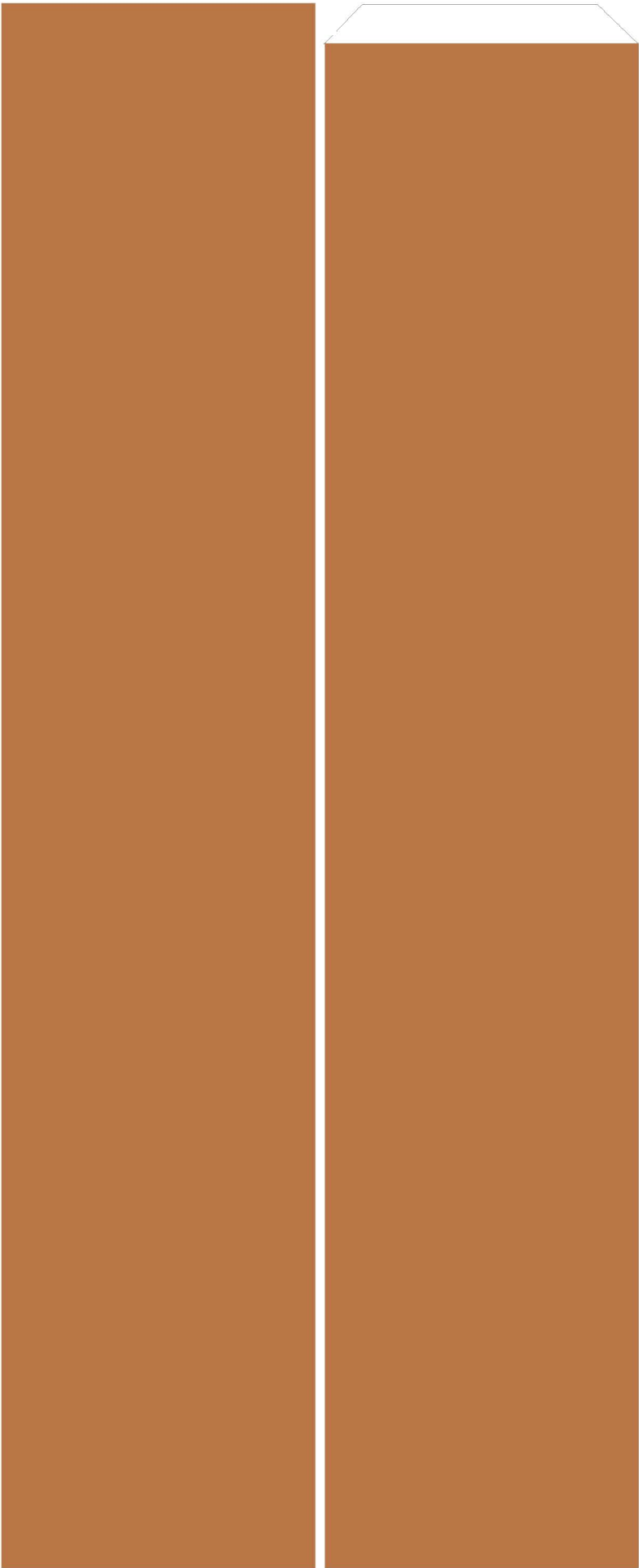

5

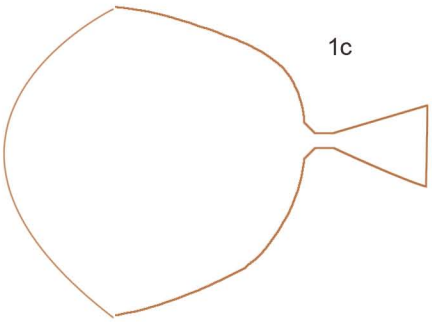

1c

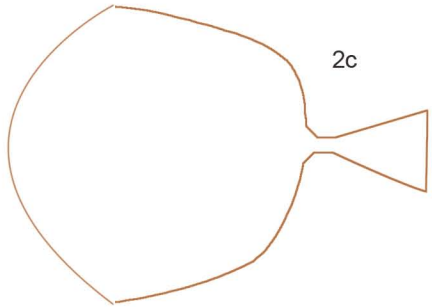

2c

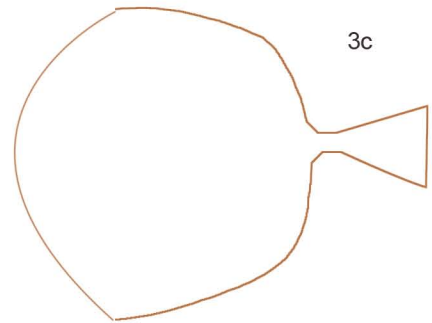

3c

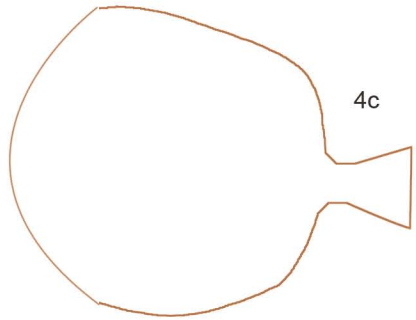

4c

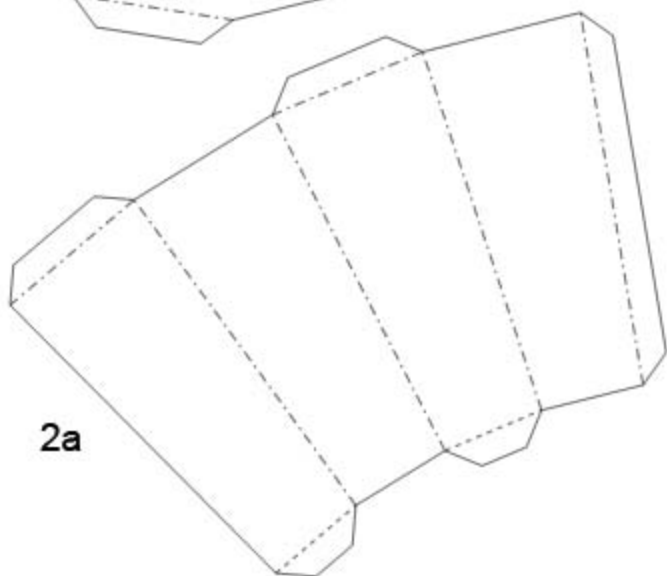
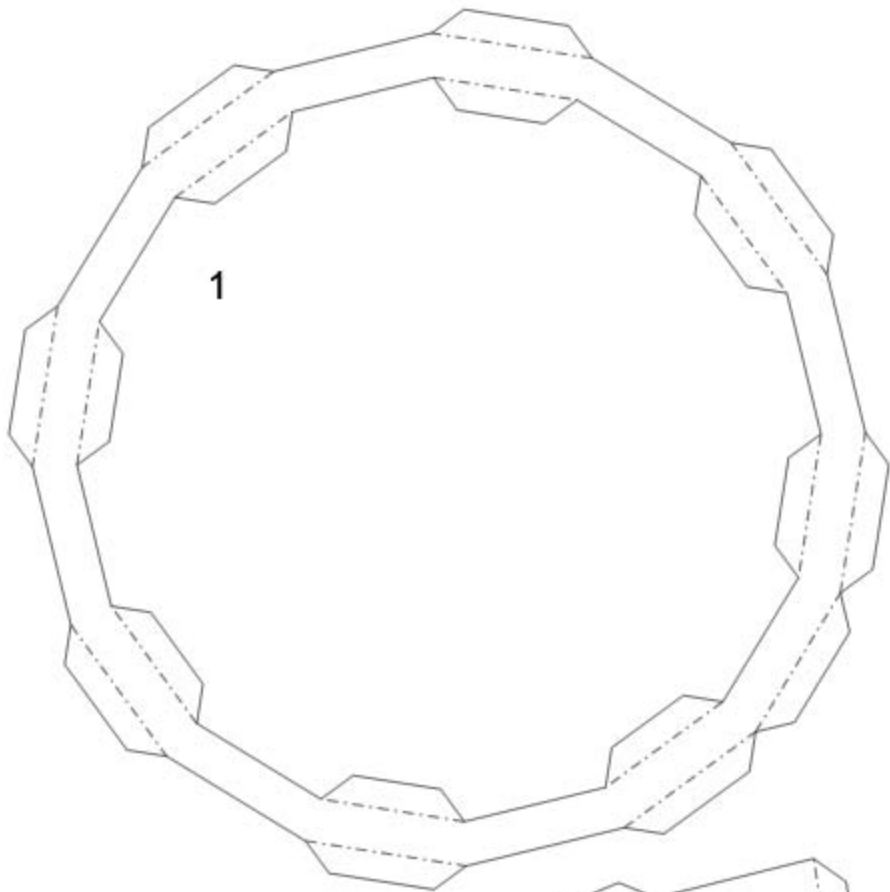

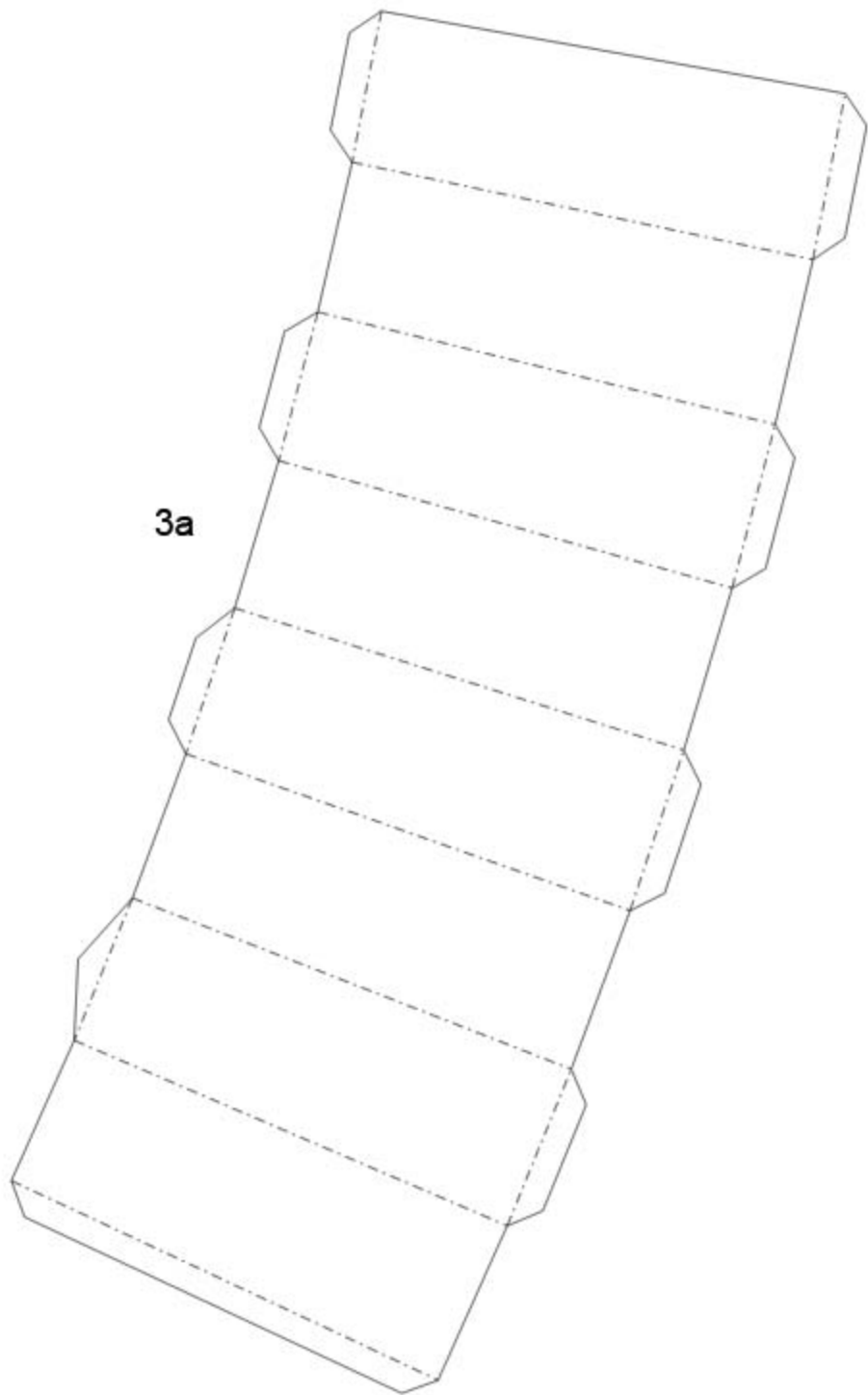



**3b**

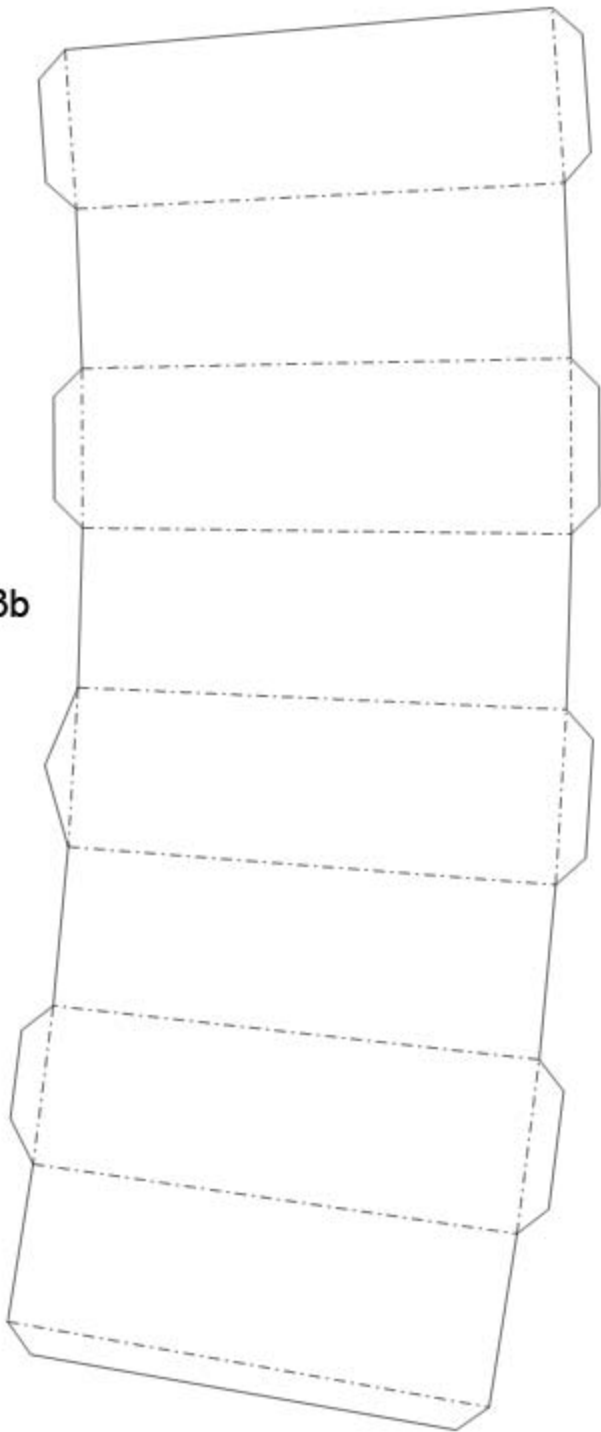

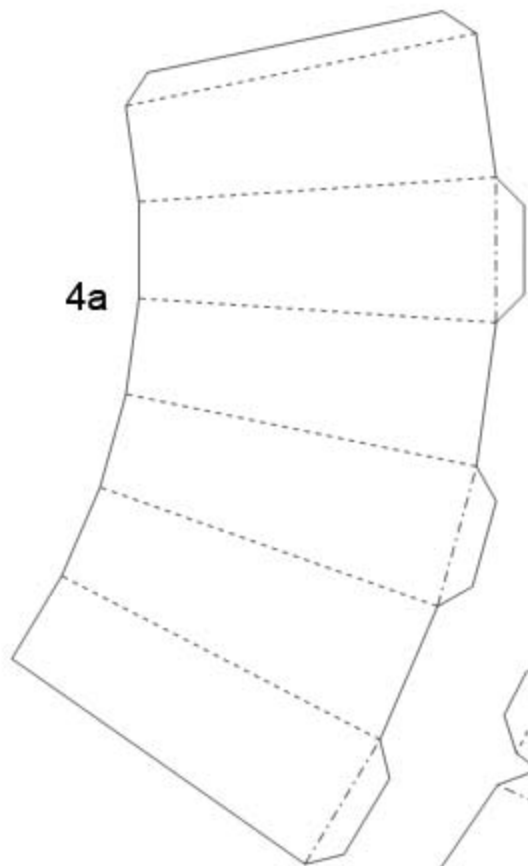

**4a**

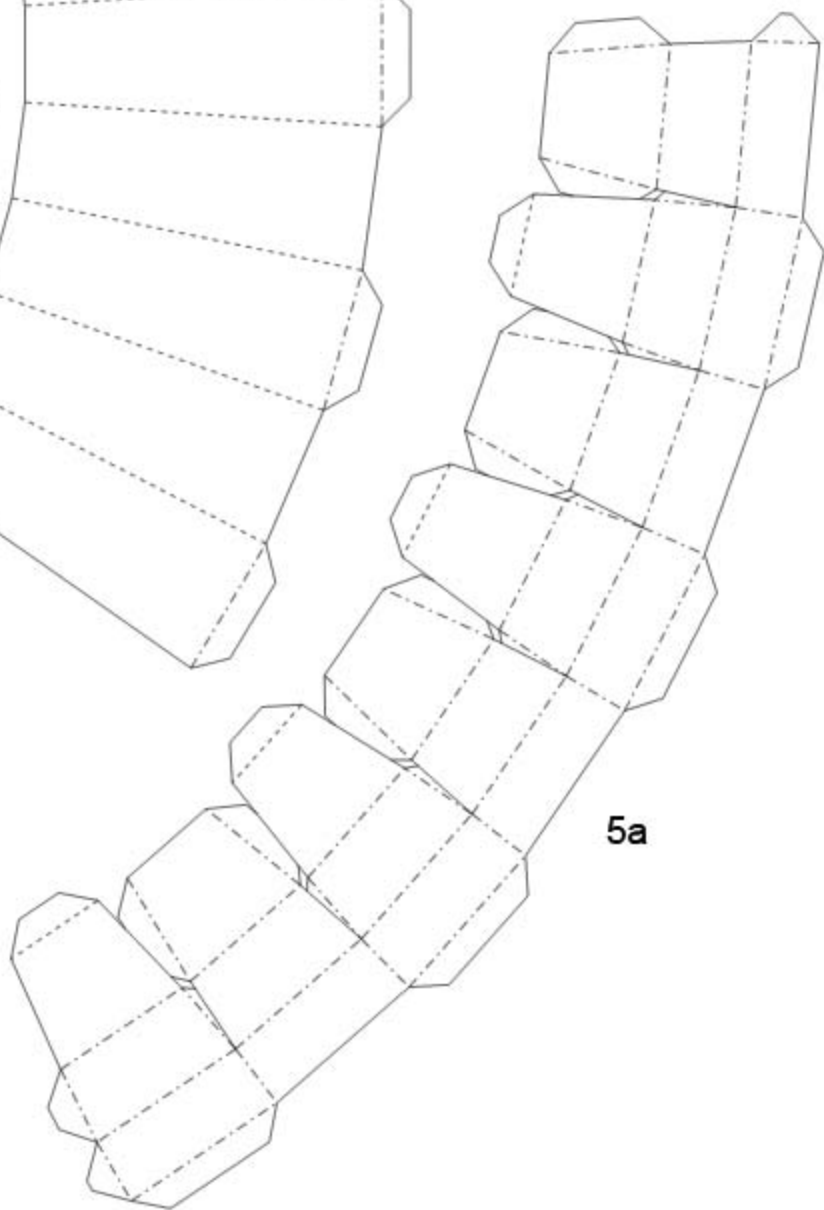

**5a**

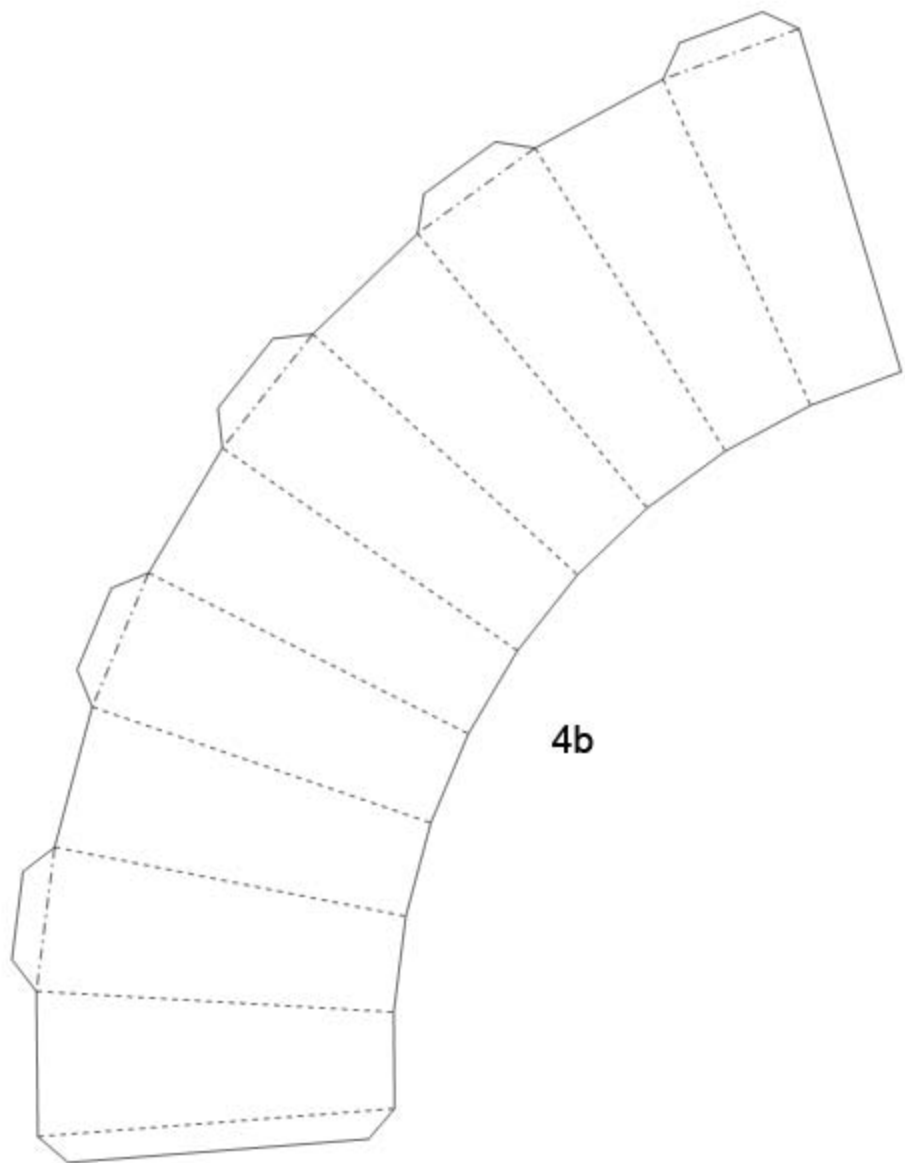

**4b**

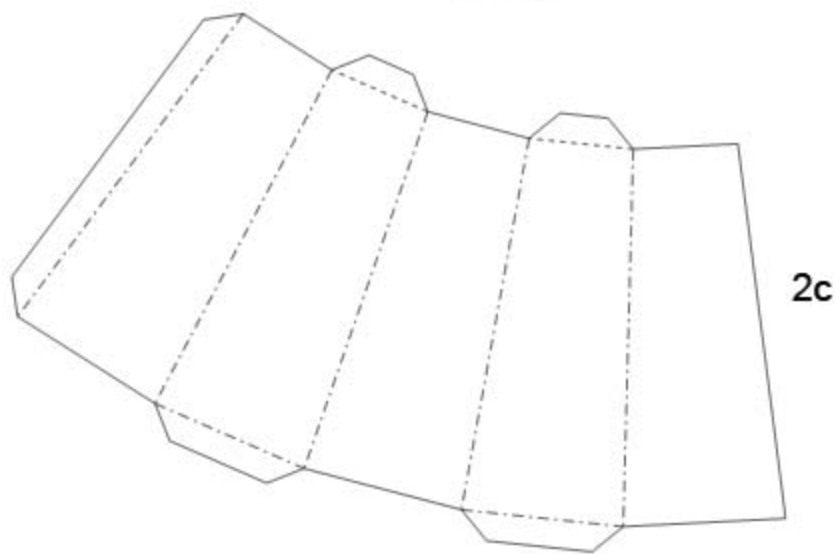
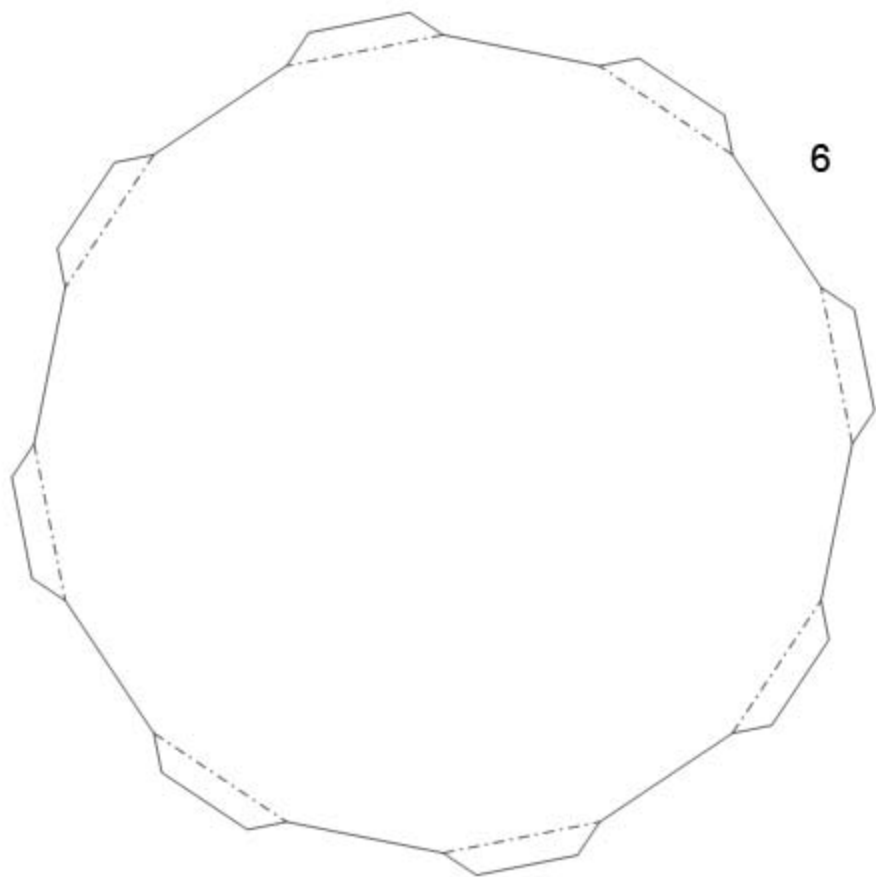

2b

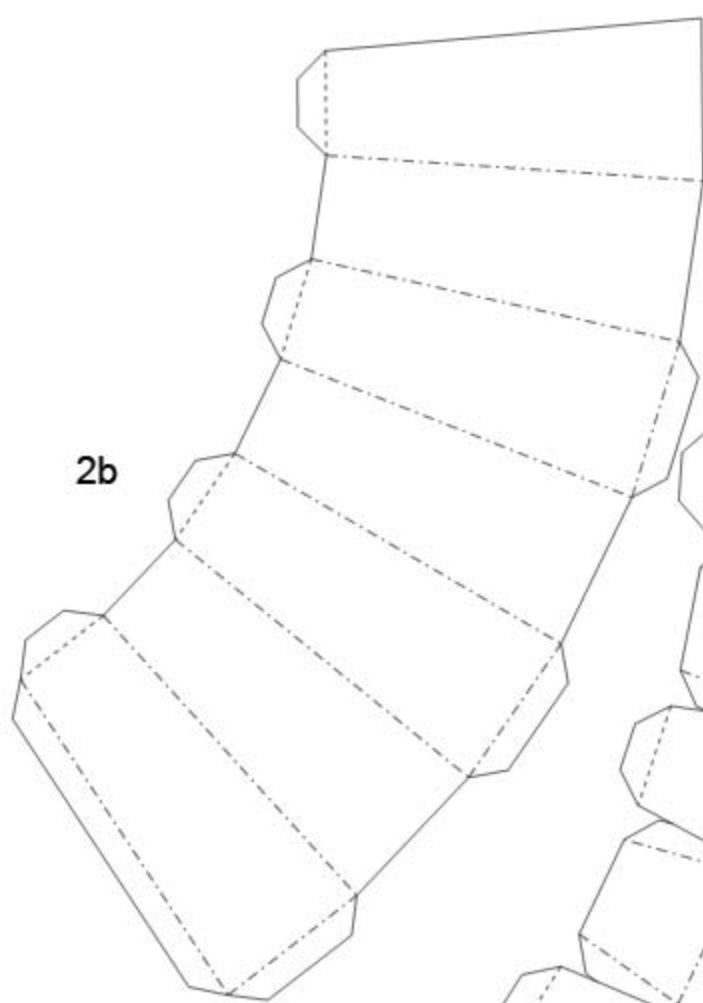

5b

